

The **SMART**  
**CHOICE** for a  
Better Network

2014 - Global Catalog

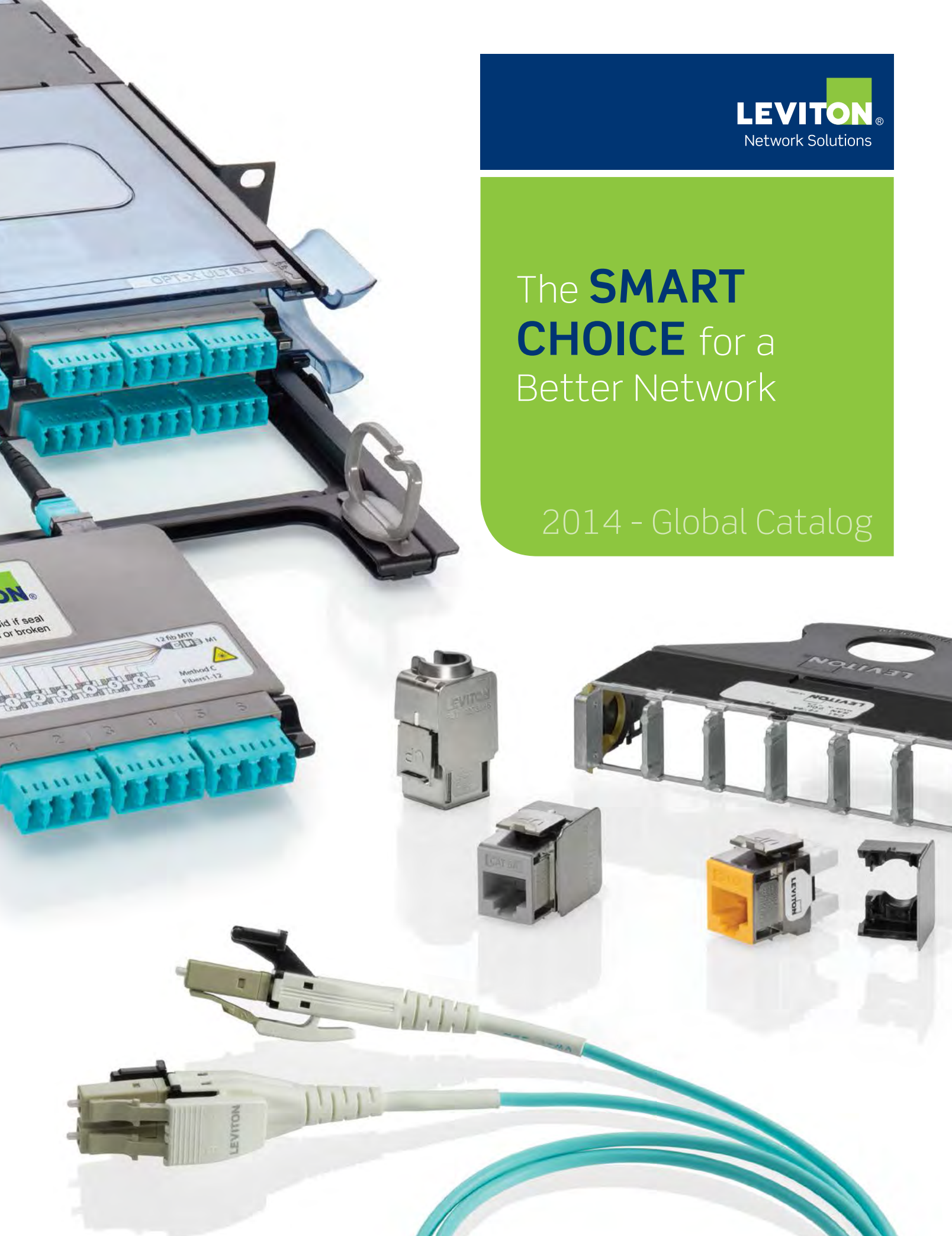

# NEW PRODUCTS



**INTACT™ INTELLIGENT PORT MANAGEMENT SYSTEM**  
See Page E3



**HIGH-FLEX HD6 PATCH CORD**  
See Page A29



**OPT-X® SPLICE MODULES**  
See Page B25



**RF TRANSPARENT ENCLOSURE**  
See Page F11



**NOISE-CANCELING HELIX TECHNOLOGY CABLE**  
See Page AA3



**OPT-X HD ENCLOSURE SYSTEM**  
See Page B11



**HIGH-DENSITY SMALL FORM FACTOR SHIELDED CONNECTORS**  
See Page A40



**HDF3168 DISTRIBUTION SYSTEM**  
See Page B7

# CATALOG CONTENTS

## ABOUT US

Enterprise Solutions	2
Data Center Solutions	4

## CABLE SOLUTIONS

Copper	AA3
Fiber	AA9

## COPPER SOLUTIONS

Copper Systems	A3
Patch Panels	A11
Cross Connect	A21
Patch Cords & Cable Assemblies	A27
Category-Rated Connectors	A35
A/V Connectivity	A41
Wallplates & Housings	A47
Copper Tools & Labeling	A65

## FIBER SOLUTIONS

Common Configurations	B3
HDF3168 Distribution System	B7
Opt-X® HD	B11
Opt-X	B15
e2XHD	B27
LightSpace®	B31
Flush-Mount Panels	B39
Equipment-Specific Solutions	B41
Pre-Terminated Cable Assemblies & Patch Cords	B45
Connectors & Housings	B59
Tools & Consumables	B67

## CABLE MANAGEMENT

Overhead Infrastructure Platform	C3
Fiber Raceway System	C5
Versi-Duct® System	C13
Cable Managers & Accessories	C15
VELCRO® Brand Fasteners	C19
Zone Enclosures	C21

## POWER SOLUTIONS

Power Distribution Units (PDUs)	D3
---------------------------------	----

## MANAGED SOLUTIONS

Intact™ Intelligent Port Management System	E3
---	----

## MDU SOLUTIONS

MDU Systems	F3
Structured Media®	F7
Audio	F27

## TECHNICAL INFORMATION

Web-Based Resources	X3
Wiring Standards	X4
Termination Instructions	X7
Splice Tray Selection Guide	X13
Product Update	X14
Product & Applications Standards	X15
Term Index	X17
Part Number Index	X23

OUTSTANDING  
**RETURN**  
ON INVESTMENT

COMMITTED TO OUR  
**CUSTOMERS & THE**  
ENVIRONMENT

**QUALITY &**  
**PERFORMANCE**  
IN EVERY SOLUTION

A CULTURE  
OF **INGENUITY**  
& **INNOVATION**

THE INDUSTRY'S  
BEST **SERVICE**  
& **SUPPORT**

THE **SMART CHOICE**  
FOR A **BETTER NETWORK**

1



#### PATCH PANELS

Wide selection of styles: flat, angled, and recessed in UTP and shielded

4

#### ZONE ENCLOSURES

Easily accessible for simple moves, adds, and changes



5

#### FIBER OPTIC ENCLOSURES

Broad selection to address any fiber density requirements



6

#### CABLE

Extensive selection of innovative copper and fiber cable to support high-density connectivity needs

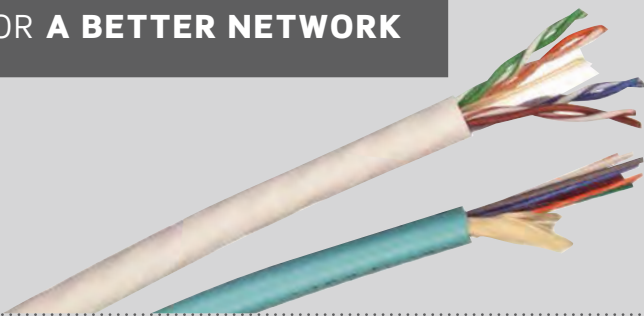

7

#### DATA CONNECTORS

Fast, reliable category-rated and optical fiber connectors



8

#### HORIZONTAL & VERTICAL CABLE MANAGEMENT

Organize and support cables, patch cords, and equipment

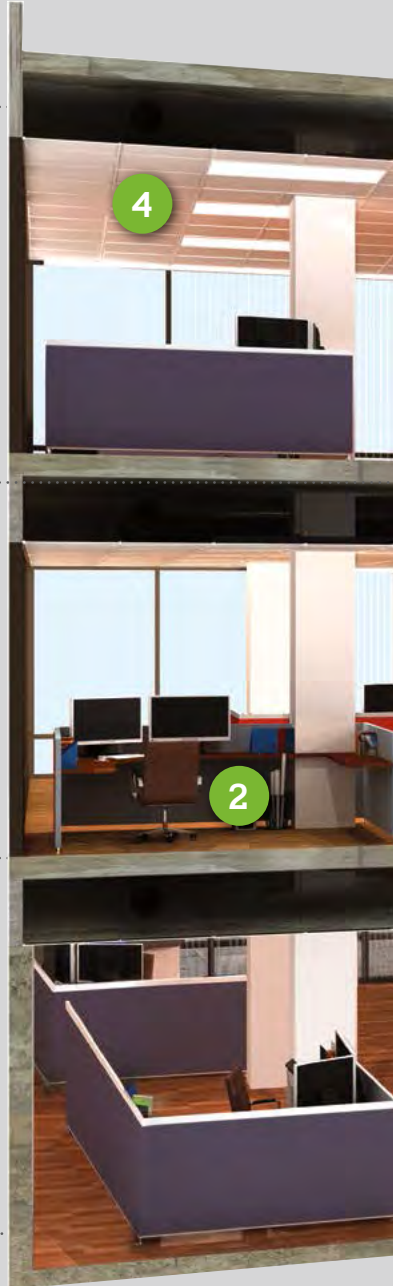

2

**PATCH CORDS**

Include snagless design and strain-relief boot for long-term performance



3

**A/V CONNECTIVITY & WALLPLATES**

For high-quality multimedia applications and customizable work-area outlets



9

**POWER DISTRIBUTION UNITS (PDUs)**

Robust, reliable power to rack and cabinet applications



10

**OPTICAL SPLICE ENCLOSURES**

Transitions from outside plant cable to inside plant cable

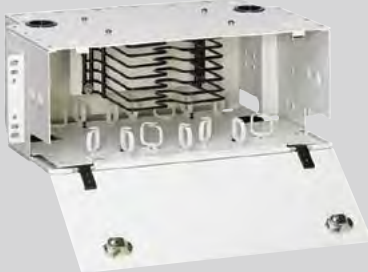



1

**HIGH-DENSITY PATCHING SYSTEM**

Fast deployment and simple maintenance



2

**REPLICATOR® ENCLOSURES**

Unique logical port management design can be configured to replicate any switch

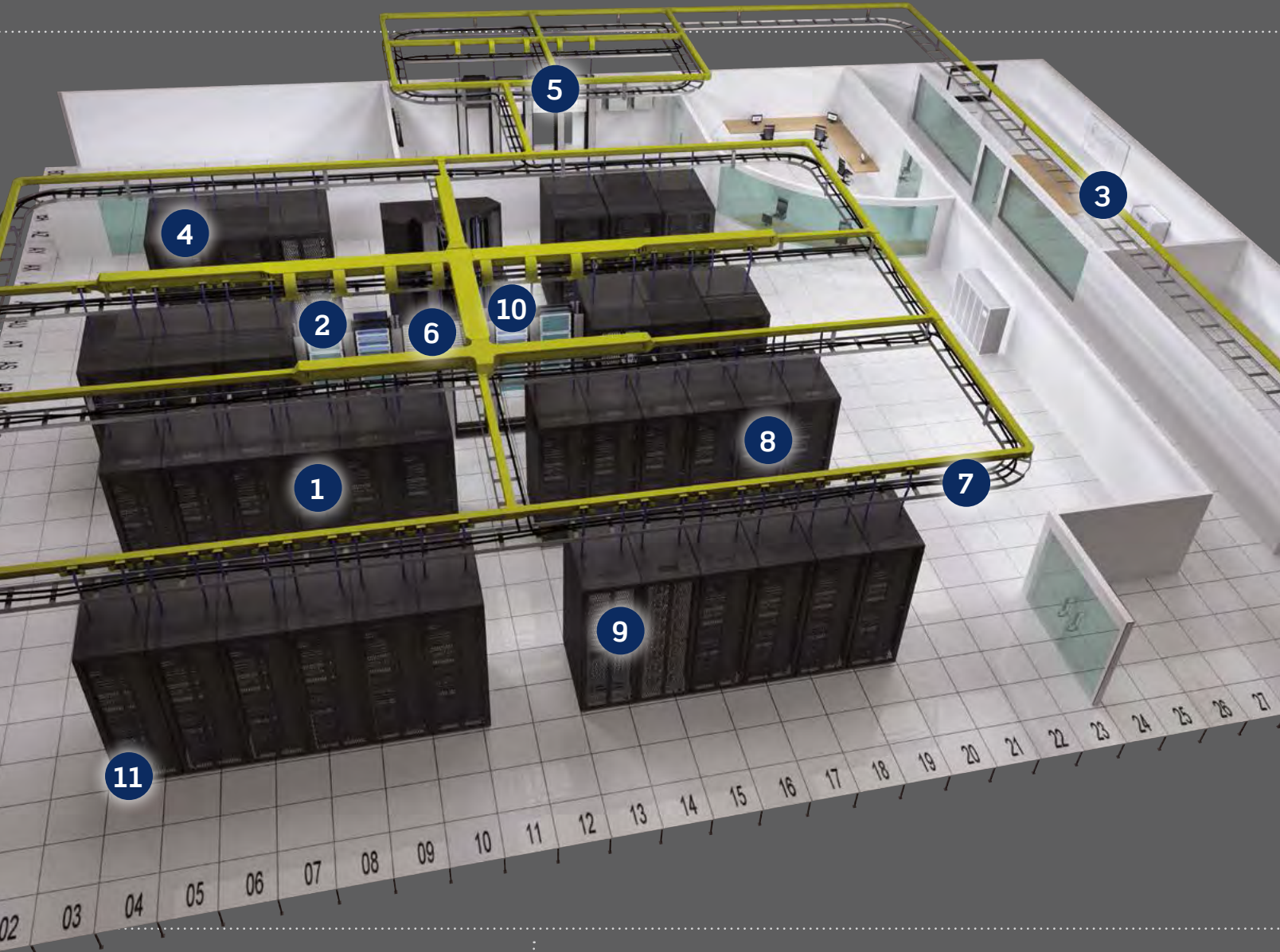

8

**40/100G MTP® SYSTEMS**

Ideal migration path to 40/100G speeds



9

**INTACT™ INTELLIGENT PORT MANAGEMENT SYSTEM**

Real-time network documentation with alerts for faults or unplanned changes



**DATA CENTER SOLUTIONS**

3

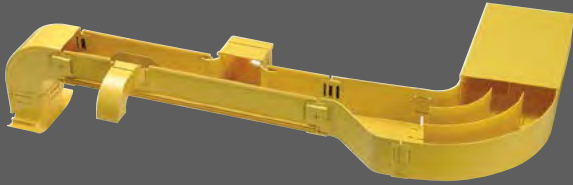

**CABLE MANAGEMENT**

Vertical/horizontal cable management for standard equipment racks and large-scale deployments

4

**SECURE CONNECTIVITY**

Physical port security with copper RJ and fiber LC assemblies



5

**CABLE**

Extensive selection of innovative copper and fiber cable to support high-density connectivity needs

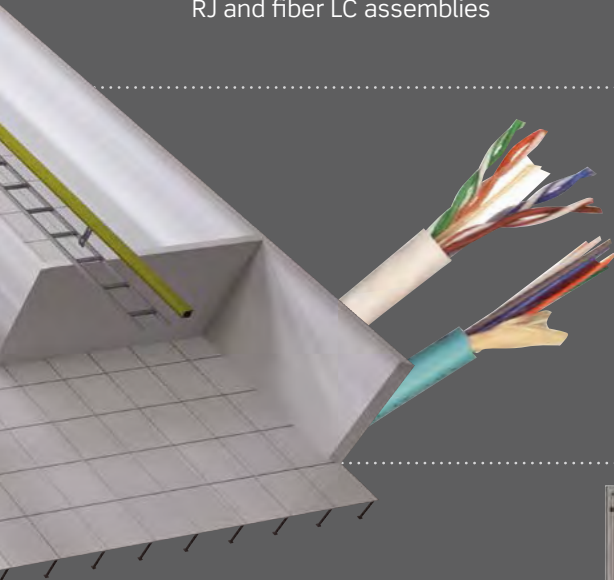

6

**HDF3168 DISTRIBUTION SYSTEM**

Used in MDA to consolidate patching and reduce footprint, freeing up valuable space



7

**PRE-TERMINATED COPPER AND FIBER TRUNKS**

Provide backbone connections between entrance facility, MDA/Core, SAN, and HDA



10

**FIBER OPTIC SYSTEMS**

High-density enclosures can be custom configured with cassettes, adapter plates, and pre-terminated solutions

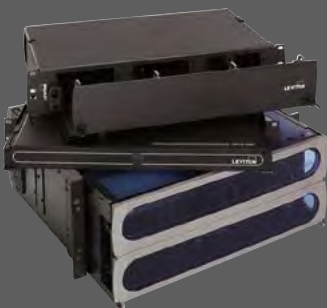

11

**POWER DISTRIBUTION UNITS**

Provide reliable power distribution into racks and cabinets with outlet power ranging from 2.0 kW to 12.5 kW



OUTSTANDING  
RETURN  
ON INVESTMENT

COMMITTED TO OUR  
CUSTOMERS & THE  
ENVIRONMENT

QUALITY &  
PERFORMANCE  
IN EVERY SOLUTION

A CULTURE  
OF **INGENUITY**  
& **INNOVATION**

THE INDUSTRY'S  
BEST **SERVICE**  
& **SUPPORT**

THE SMART CHOICE  
FOR A **BETTER NETWORK**

# CABLE

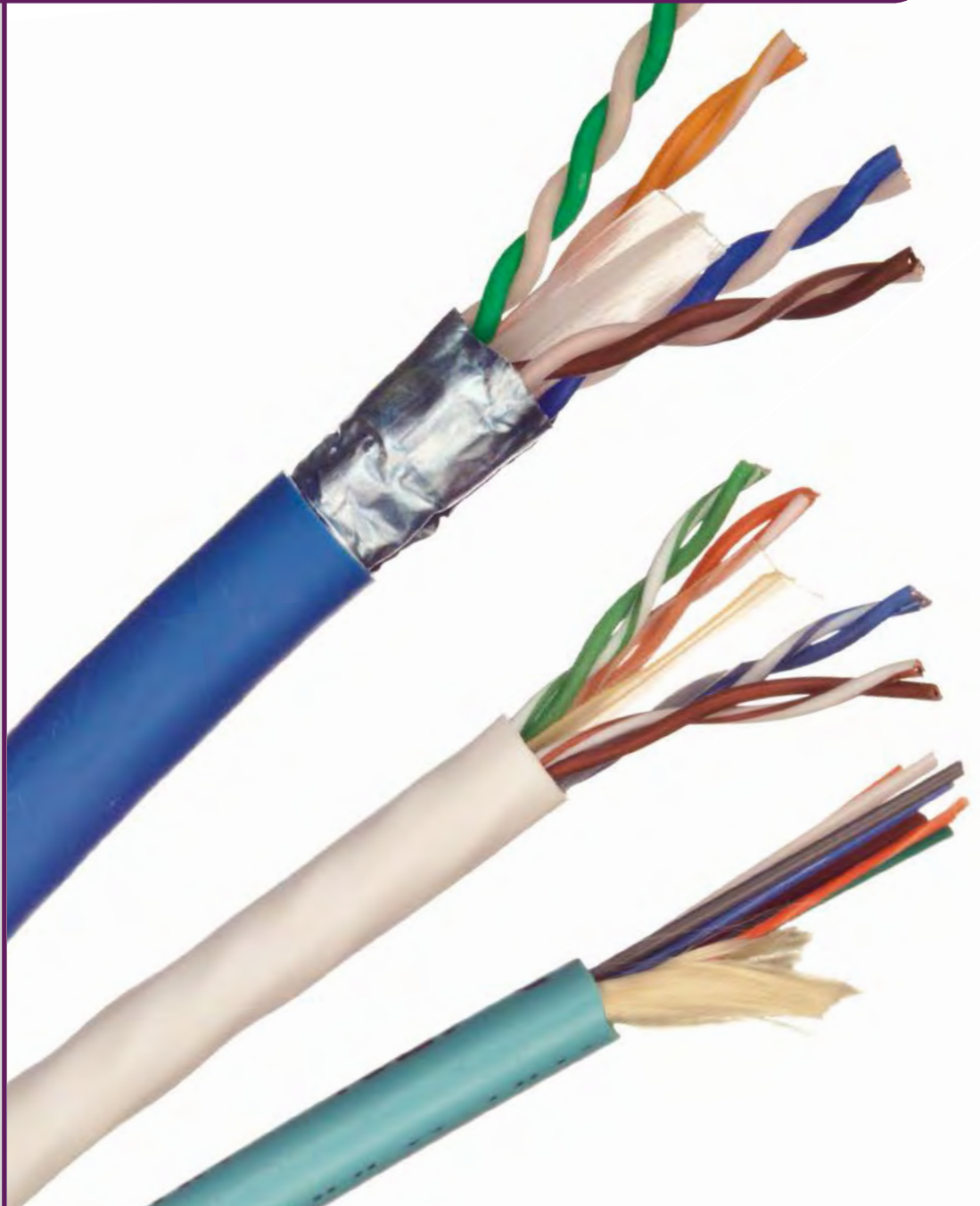

SECTION





---

## SECTION **AA** CONTENTS

COPPER CABLE	<b>AA3</b>	CAT 6A UTP Cable
	<b>AA4</b>	CAT 6A Shielded Cable
	<b>AA5</b>	CAT 6 UTP Cable
	<b>AA7</b>	CAT 6 & 5e Shielded Cable
	<b>AA8</b>	CAT 5e UTP Cable
FIBER CABLE	<b>AA9</b>	Distribution Fiber Cable
	<b>AA10</b>	Indoor/Outdoor Central Loose Tube Fiber Cable

# CABLE | CAT 6A UTP Cable

copper

CABLE

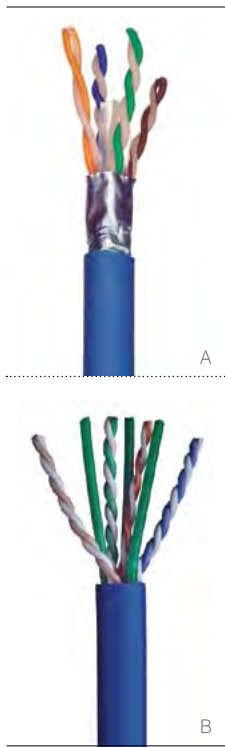

## CAT 6A UTP LEVITON PATENTED NOISE-CANCELING HELIX TECHNOLOGY CABLE

- Patented Leviton design provides superior alien crosstalk suppression
- Small cable OD (7.3 mm) increases pathway capacity and improves airflow to critical active equipment
- UTP cable eliminates the need for grounding and bonding
- Smaller, lighter, and more flexible, saving time during installation and reducing labor costs
- 3rd-party verified to support short channels (9.14 meters)
- Independently tested and verified to meet ANSI/TIA CAT 6A and ISO 11801 Class E<sub>A</sub> performance
- IEC 60332-1 (LSZH) flame rating

## CAT 6A UTP CABLE

- Independently tested and verified to meet ANSI/TIA CAT 6A and ISO 11801 Class E<sub>A</sub> performance
- Non-metallic cross separator isolates twisted pairs
- Round, compact design provides easier installation and cable management
- Provides bandwidth required for multimedia, video, and other future applications
- Available in Plenum, Riser, and Low-Smoke Zero Halogen flame ratings

AVAILABLE IN THESE REGIONS\*

CAT 6A LEVITON PATENTED NOISE-CANCELING HELIX TECHNOLOGY CABLE			AVAILABLE IN THESE REGIONS*						
DESCRIPTION	PART NO.		CANADA	LATIN AMERICA	EUROPE	AFRICA	MIDDLE EAST	INDIA	ASIA
<b>[A]</b> CAT 6A UTP Cable, Low-Smoke Zero Halogen, blue, 305-meter spool	100-DUTAZ-MLS			x	x	x	x	x	x
CAT 6A UTP Cable, Low-Smoke Zero Halogen, grey, 305-meter spool	101-DUTAZ-MSS			x	x	x	x	x	x
CAT 6A UTP Cable, Low-Smoke Zero Halogen, white, 305-meter spool	102-DUTAZ-MWS			x	x	x	x	x	x
CAT 6A UTP CABLE, LOW-SMOKE ZERO HALOGEN									
<b>[B]</b> CAT 6A UTP Cable, Low-Smoke Zero Halogen, blue, 305-meter spool	203-UTCAZ-MLS			x	x	x	x	x	x
CAT 6A UTP Cable, Low-Smoke Zero Halogen, grey, 305-meter spool	205-UTCAZ-MSS			x	x	x	x	x	x
CAT 6A UTP CABLE, PLENUM RATED									
CAT 6A UTP Cable, Plenum Rated, blue, 305-meter spool	110-EUTAP-MLS		x	x			x		x
CAT 6A UTP Cable, Plenum Rated, grey, 305-meter spool	111-EUTAP-MSS		x	x			x		x
CAT 6A UTP Cable, Plenum Rated, white, 305-meter spool	112-EUTAP-MWS		x	x			x		x
CAT 6A UTP CABLE, RISER RATED									
CAT 6A UTP Cable, Riser Rated, blue, 305-meter spool	100-UTPAR-MLS			x			x		x
CAT 6A UTP Cable, Riser Rated, grey, 305-meter spool	101-UTPAR-MSS			x			x		x
CAT 6A UTP Cable, Riser Rated, blue, 305-meter spool	110-EUTAR-MLS		x	x			x		x
CAT 6A UTP Cable, Riser Rated, grey, 305-meter spool	111-EUTAR-MSS		x	x			x		x
CAT 6A UTP Cable, Riser Rated, white, 305-meter spool	112-EUTAR-MWS		x	x			x		x

\* = For all regions not indicated, orders may incur additional lead times, minimum order quantities, and additional charges. Please consult with inside sales. Information subject to change. Please consult [leviton.com/cable](http://leviton.com/cable) or contact inside sales for current listing.



**CAT 6A SHIELDED CABLE**

- Mylar tape and aluminum shield provide a high level of security for sensitive networks
- Lower bit errors, resulting in increased network performance
- Independently tested and verified to meet ANSI/TIA CAT 6A and ISO 11801 Class E<sub>A</sub> performance
- Available in Riser and Low-Smoke Zero Halogen flame ratings

AVAILABLE IN THESE REGIONS\*

CAT 6A F/UTP CABLE		CANADA	LATIN AMERICA	EUROPE	AFRICA	MIDDLE EAST	INDIA	ASIA
DESCRIPTION	PART NO.							
[A] CAT 6A F/UTP Cable, Low-Smoke Zero Halogen, blue, 305-meter spool	100-FTPAZ-MLS		x	x	x	x		x
CAT 6A F/UTP Cable, Low-Smoke Zero Halogen, grey, 305-meter spool	101-FTPAZ-MSS		x	x	x	x		x
CAT 6A F/UTP Cable, Low-Smoke Zero Halogen, white, 500-meter spool	102-FTPAZ-5WS		x	x	x	x		x
CAT 6A F/UTP Cable, Low-Smoke Zero Halogen, white, 500-meter spool	160-FTPAZ-5WS			x		x		
CAT 6A F/UTP Cable, Riser Rated, blue, 305-meter spool	100-FTPAR-MLS		x			x		x
CAT 6A F/UTP Cable, Riser Rated, grey, 305-meter spool	101-FTPAR-MSS		x			x		x
CAT 6A S/FTP CABLE								
CAT 6A S/FTP Cable, Low-Smoke Zero Halogen, white, 500-meter spool	160-SFTAZ-5WS			x		x		
CAT 6A S/FTP Cable, Low-Smoke Zero Halogen, white, 500-meter spool	180-SFTAZ-5WS		x	x	x	x	x	x
CAT 6A S/FTP Cable, Low-Smoke Zero Halogen, grey, 500-meter spool	181-SFTAZ-5SS		x	x	x	x	x	x
CAT 6A S/FTP Cable, Low-Smoke Zero Halogen, white, 500-meter spool	160-SFSAZ-5WS			x		x		
CAT 6A U/FTP CABLE								
CAT 6A U/FTP Cable, Low-Smoke Zero Halogen, white, 500-meter spool	180-UFPAZ-5WS		x	x	x	x		x

\* = For all regions not indicated, orders may incur additional lead times, minimum order quantities, and additional charges. Please consult with inside sales. Information subject to change. Please consult [leviton.com/cable](http://leviton.com/cable) or contact inside sales for current listing.

**SPOTLIGHT** Patented Noise-Canceling Helix Technology



Leviton CAT 6A UTP cable features innovative Noise-Canceling Helix Technology to reduce incoming and outgoing electromagnetic interference (EMI) and provide exceptional alien crosstalk performance. Gaps in the Mylar wrap prohibit a current from being carried throughout the length of the cable. This eliminates the need for grounding and bonding, saving time during installation and significantly reducing labor costs.

# CABLE | CAT 6 UTP Cable

CABLE  
copper



A



B

## CAT 6+ UTP CABLE, LOW-SMOKE ZERO HALOGEN

- Meets ANSI/TIA-568-C.2 and ISO/IEC 11801 Class E standards
- Optimum support for Gigabit Ethernet
- IEC 60332-1 (vertical flame test) fire rated
- Supports IEEE 802.3: 1000BASE-T (Gigabit Ethernet), 100BASE-T (fast Ethernet), and 10BASE-T applications
- Includes non-metallic cross separator allowing for stronger signal strength and less vulnerability to noise interference

## CAT 6+ UTP CABLE, PLENUM

- Meets ANSI/TIA-568-C.2, ISO/IEC 11801 Class E, IEC 61156-5, EN50173, and RoHS Compliant standards
- Supports IEEE 802.3: 1000BASE-T (Gigabit Ethernet), 100BASE-T (fast Ethernet), and 10BASE-T applications
- Includes non-metallic cross separator allowing for stronger signal strength and less vulnerability to noise interference

### AVAILABLE IN THESE REGIONS\*

	CANADA	LATIN AMERICA	EUROPE	AFRICA	MIDDLE EAST	INDIA	ASIA
<b>[A]</b> CAT 6 UTP Cable, Low-Smoke Zero Halogen, blue, 305-meter reel in box		x	x	x	x		x
CAT 6 UTP Cable, Low-Smoke Zero Halogen, grey, 305-meter reel in box		x	x	x	x	x	x
CAT 6 UTP Cable, Low-Smoke Zero Halogen, blue, 305-meter spool		x	x	x	x		x
CAT 6 UTP Cable, Low-Smoke Zero Halogen, grey, 305-meter spool		x	x	x	x		x
CAT 6 UTP Cable, Low-Smoke Zero Halogen, white, 305-meter reel in box		x	x	x	x		x
CAT 6 UTP Cable, Low-Smoke Zero Halogen, white, 500-meter spool			x		x		
CAT 6 UTP Cable, Low-Smoke Zero Halogen, grey, 305-meter reel in box			x		x		
<b>[B]</b> CAT 6 UTP Cable, Low-Smoke Zero Halogen, white, 305-meter reel in box			x		x		
CAT 6 UTP Cable, Low-Smoke Zero Halogen, white, 500-meter spool			x		x		
CAT 6 UTP Cable, Low-Smoke Zero Halogen, grey, 305-meter reel in box			x		x		
CAT 6 UTP Cable, Low-Smoke Zero Halogen, blue, 305-meter reel in box			x		x		
CAT 6 UTP Cable, Low-Smoke Zero Halogen, blue, 305-meter reel in box						x	
CAT 6 UTP Cable, Low-Smoke Zero Halogen, grey, 305-meter reel in box						x	
<b>CAT 6 UTP CABLE, PLENUM-RATED</b>							
CAT 6 UTP Cable, Plenum Rated, blue, 305-meter reel in box	x	x		x	x	x	x
CAT 6 UTP Cable, Plenum Rated, grey, 305-meter reel in box	x	x		x	x		x
CAT 6 UTP Cable, Plenum Rated, white, 305-meter reel in box	x	x		x	x		x

\* = For all regions not indicated, orders may incur additional lead times, minimum order quantities, and additional charges. Please consult with inside sales. Information subject to change. Please consult [leviton.com/cable](http://leviton.com/cable) or contact inside sales for current listing.



**CAT 6+ UTP CABLE, RISER RATED**

- Meets ANSI/TIA-568-C.2, ISO/IEC 11801 Class E, IEC 61156-5, EN50173, and RoHS Compliant standards
- Optimum support for Gigabit Ethernet
- Supports IEEE 802.3: 1000BASE-T (Gigabit Ethernet), 100BASE-T (fast Ethernet), and 10BASE-T applications
- Includes non-metallic cross separator allowing for stronger signal strength and less vulnerability to noise interference



**CAT 6+ UTP CABLE, PVC**

- Meets ANSI/TIA-568-C.2, ISO/IEC 11801 Class E, IEC 61156-5, EN50173
- Supports IEEE 802.3: 1000BASE-T (Gigabit Ethernet), 100BASE-T (fast Ethernet), and 10 BASE-T applications
- Includes non-metallic cross separator allowing for stronger signal strength and less vulnerability to noise interference

**CAT 6+ UTP CABLE, CM**

- Meets ANSI/TIA-568-C.2, ISO/IEC 11801 Class E, IEC 61156-5, EN50173, and RoHS Compliant standards
- Optimum support for Gigabit Ethernet
- IEC 60332-1 (vertical flame test) and UL1581 FT2 (horizontal flame test) fire rated
- Supports IEEE 802.3: 1000BASE-T (Gigabit Ethernet), 100BASE-T (fast Ethernet), and 10BASE-T applications
- Includes non-metallic cross separator allowing for stronger signal strength and less vulnerability to noise interference

AVAILABLE IN THESE REGIONS\*

CAT 6 UTP CABLE, RISER RATED			AVAILABLE IN THESE REGIONS*						
DESCRIPTION	PART NO.		CANADA	LATIN AMERICA	EUROPE	AFRICA	MIDDLE EAST	INDIA	ASIA
<b>[A]</b> CAT 6 UTP Cable, Riser Rated, blue, 305-meter reel in box	104-UTP6R-MLB			x			x		x
CAT 6 UTP Cable, Riser Rated, grey, 305-meter reel in box	105-UTP6R-MSB			x			x		x
CAT 6 UTP Cable, Riser Rated, blue, 305-meter reel in box	110-EUT6R-MLB	x	x				x		x
CAT 6 UTP Cable, Riser Rated, grey, 305-meter reel in box	111-EUT6R-MSB	x	x				x		x
<b>[B]</b> CAT 6 UTP Cable, Riser Rated, white, 305-meter reel in box	112-EUT6R-MWB	x	x				x		x
CAT 6 UTP Cable, Riser Rated, grey, 305-meter reel in box	114-UTP6R-MSB			x			x		x
CAT 6 UTP CABLE, CM									
CAT 6 UTP Cable, CM Rated, blue, 305-meter reel in box	100-UTP6M-MLB				x		x		
CAT 6 UTP Cable, CM Rated, grey, 305-meter reel in box	101-UTP6M-MSB			x			x		x
CAT 6 UTP Cable, CM Rated, yellow, 305-meter reel in box	104-UTP6M-MYB			x	x	x	x		x
CAT 6 UTP Cable, CM Rated, white, 305-meter reel in box	105-UTP6M-MWB			x	x	x	x		x
CAT 6 UTP Cable, CM Rated, red, 305-meter reel in box	106-UTP6M-MRB			x	x	x	x		x
CAT 6 UTP Cable, CM Rated, green, 305-meter reel in box	108-UTP6M-MGB			x	x	x	x		x
CAT 6 UTP Cable, CM Rated, blue, 305-meter reel in box	296-UTP6M-MLB			x	x	x	x	x	x
CAT 6 UTP Cable, CM Rated, grey, 305-meter reel in box	297-UTP6M-MSB			x	x	x	x	x	x
CAT 6 UTP Cable, CM Rated, blue, 305-meter reel in box	300-UTP6M-MLB							x	
CAT 6 UTP Cable, CM Rated, grey, 305-meter reel in box	301-UTP6M-MSB							x	
CAT 6 UTP CABLE, PVC									
CAT 6 UTP Cable, PVC, blue, 305-meter reel in box	100-UTP6N-MLB			x			x		x
CAT 6 UTP Cable, PVC, grey, 305-meter reel in box	101-UTP6N-MSB			x			x		x
CAT 6 UTP Cable, PVC, blue, 305-meter spool	102-UTP6N-MLS			x			x		x
CAT 6 UTP Cable, PVC, grey, 305-meter spool	103-UTP6N-MSS			x			x		x
CAT 6 UTP Cable, PVC, blue, 305-meter reel in box	180-UTP6N-MLB				x		x		
CAT 6 UTP Cable, PVC, blue, 305-meter reel in box	181-UTP6N-MSB				x		x		

\* = For all regions not indicated, orders may incur additional lead times, minimum order quantities, and additional charges. Please consult with inside sales. Information subject to change. Please consult leviton.com/cable or contact inside sales for current listing.

# CABLE | CAT 6 & 5e Shielded Cable

CABLE  
copper



## CAT 6 SHIELDED CABLE

- Mylar tape and aluminum shield offers increased signal isolation, preventing contaminant noise from entering system
- Optimal support for Gigabit Ethernet
- Reduces signal emissions for secure transmissions
- Independently tested and verified to exceed ANSI/TIA-568-C.2 CAT 6, IEEE 802.3an 1000 BASE-T, and ISO/IEC 11801 Class E standards
- Available in CM and Low-Smoke Zero Halogen flame ratings

AVAILABLE IN THESE REGIONS\*

	CANADA	LATIN AMERICA	EUROPE	AFRICA	MIDDLE EAST	INDIA	ASIA
CAT 6 F/UTP Cable, CM Rated, blue, 305-meter spool		x	x	x	x		x
[A] CAT 6 F/UTP Cable, Low-Smoke Zero Halogen, grey, 305-meter spool		x	x	x	x		x
CAT 6 F/UTP Cable, Low-Smoke Zero Halogen, white, 500-meter spool			x		x		
CAT 6 F/UTP Cable, Low-Smoke Zero Halogen, white, 500-meter spool			x		x		

## CAT 6 SHIELDED CABLE

DESCRIPTION	PART NO.
CAT 6 F/UTP Cable, CM Rated, blue, 305-meter spool	100-FTP6M-MLS
[A] CAT 6 F/UTP Cable, Low-Smoke Zero Halogen, grey, 305-meter spool	101-FTP6Z-MSS
CAT 6 F/UTP Cable, Low-Smoke Zero Halogen, white, 500-meter spool	160-FTP6Z-5WS
CAT 6 F/UTP Cable, Low-Smoke Zero Halogen, white, 500-meter spool	180-FTP6Z-5WS

\* = For all regions not indicated, orders may incur additional lead times, minimum order quantities, and additional charges. Please consult with inside sales. Information subject to change. Please consult [leviton.com/cable](http://leviton.com/cable) or contact inside sales for current listing.

## CAT 5e SHIELDED CABLE

- Mylar tape and aluminum shield reduces signal interference problems in areas of high EMI
- Supports 10BASE-T, 100BASE-T, and 1000BASE-T Ethernet
- Independently tested and verified to exceed ANSI/TIA-568-C.2 CAT 5e, IEEE 802.3 1000 BASE-T, and ISO/IEC 11801 Class D standards
- Available in Low Smoke Zero Halogen flame rating

AVAILABLE IN THESE REGIONS\*

	CANADA	LATIN AMERICA	EUROPE	AFRICA	MIDDLE EAST	INDIA	ASIA
CAT 5e F/UTP Cable, Low-Smoke Zero Halogen, white, 500-meter spool			x	x	x		

## CAT 5e SHIELDED CABLE

DESCRIPTION	PART NO.
CAT 5e F/UTP Cable, Low-Smoke Zero Halogen, white, 500-meter spool	180-FTP5Z-5WS

\* = For all regions not indicated, orders may incur additional lead times, minimum order quantities, and additional charges. Please consult with inside sales. Information subject to change. Please consult [leviton.com/cable](http://leviton.com/cable) or contact inside sales for current listing.

### SPOTLIGHT

### Reel-In-A-Box Cable Packaging



To support easier storage and dispensing during installation, Leviton provides cable on a reel-in-a-box. The reel-in-the-box reduces stress on coils during handling to maintain high levels of performance and minimizes waste associated with tangled cable.



**CAT 5e UTP CABLE**

- Supports 10BASE-T, 100BASE-T, and 1000BASE-T Ethernet
- Independently tested and verified to exceed ANSI/TIA-568-C.2 CAT 5e, IEEE 802.3 1000 BASE-T, and ISO/IEC 11801 Class D standards
- Available in Plenum, Riser, CM, Low-Smoke Zero Halogen, and PVC cable jackets

AVAILABLE IN THESE REGIONS\*

CAT 5e UTP CABLE, LOW-SMOKE ZERO HALOGEN			CANADA	LATIN AMERICA	EUROPE	AFRICA	MIDDLE EAST	INDIA	ASIA
DESCRIPTION	PART NO.								
<b>[A]</b> CAT 5e UTP Cable, Low-Smoke Zero Halogen, blue, 305-meter reel in box	100-UTP5Z-MLB			x			x		x
CAT 5e UTP Cable, Low-Smoke Zero Halogen, grey, 305-meter reel in box	101-UTP5Z-MSB			x			x		x
CAT 5e UTP Cable, Low-Smoke Zero Halogen, blue, 305-meter spool	102-UTP5Z-MLS			x			x		x
CAT 5e UTP Cable, Low-Smoke Zero Halogen, grey, 305-meter spool	103-UTP5Z-MSS			x			x		x
CAT 5e UTP Cable, Low-Smoke Zero Halogen, white, 305-meter reel in box	154-UTP5Z-MWB				x		x		
CAT 5e UTP Cable, Low-Smoke Zero Halogen, white, 500-meter spool	155-UTP5Z-5WS				x		x		
CAT 5E UTP CABLE, PLENUM RATED									
CAT 5e UTP Cable, Plenum Rated, blue, 305-meter reel in box	110-EUT5P-MLB		x	x			x		x
CAT 5e UTP Cable, Plenum Rated, white, 305-meter reel in box	112-EUT5P-MWB		x	x			x		x
CAT 5E UTP CABLE, RISER RATED									
CAT 5e UTP Cable, Riser Rated, blue, 305-meter reel in box	110-EUT5R-MLB		x	x			x		x
CAT 5e UTP Cable, Riser Rated, grey, 305-meter reel in box	111-EUT5R-MSB		x	x			x		x
CAT 5e UTP Cable, Riser Rated, white, 305-meter reel in box	112-EUT5R-MWB		x	x			x		x
CAT 5e UTP Cable, Riser Rated, blue, 305-meter reel in box	290-UTP5R-MLB			x			x		x
CAT 5e UTP Cable, Riser Rated, white, 305-meter reel in box	291-UTP5R-MWB			x			x		x
CAT 5e UTP Cable, Riser Rated, grey, 305-meter reel in box	292-UTP5R-MSB			x			x		x
CAT 5E UTP CABLE, CM									
CAT 5e UTP Cable, CM Rated, blue, 305-meter spool	102-UTP5M-MLS				x		x		
CAT 5e UTP Cable, CM Rated, grey, 305-meter spool	103-UTP5M-MSS				x		x		
CAT 5e UTP Cable, CM Rated, white, 305-meter reel in box	104-UTP5M-MWB		x	x	x	x			x
CAT 5e UTP Cable, CM Rated, red, 305-meter reel in box <sup>^</sup>	105-UTP5M-MRB		x	x	x	x			x
CAT 5e UTP Cable, CM Rated, yellow, 305-meter reel in box <sup>^</sup>	107-UTP5M-MYB		x	x	x	x			x
CAT 5e UTP Cable, CM Rated, blue, 305-meter reel in box	290-UTP5M-MLB		x	x	x	x			x
CAT 5e UTP Cable, CM Rated, grey, 305-meter reel in box	291-UTP5M-MSB		x	x	x	x	x	x	x
CAT 5E UTP CABLE, PVC									
CAT 5e UTP Cable, PVC, blue, 305-meter reel in box	100-UTP5N-MLB		x	x	x	x			x
CAT 5e UTP Cable, PVC, grey, 305-meter reel in box	101-UTP5N-MSB		x	x	x	x			x
CAT 5e UTP Cable, PVC, blue, 305-meter spool	102-UTP5N-MLS		x	x	x	x			x
CAT 5e UTP Cable, PVC, grey, 305-meter spool	103-UTP5N-MSS		x	x	x	x			x

\* = For all regions not indicated, orders may incur additional lead times, minimum order quantities, and additional charges. Please consult with inside sales.  
<sup>^</sup> = Requires additional lead time. Contact inside sales for more information.  
 Information subject to change. Please consult [leviton.com/cable](http://leviton.com/cable) or contact inside sales for current listing.

# CABLE | Distribution Fiber Cable

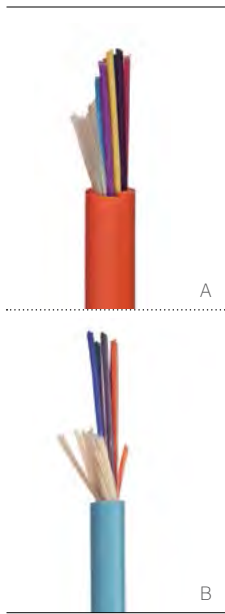

## INDOOR DISTRIBUTION RISER RATED

- Ideal for LAN backbone and premises wiring
- Tight-buffered, 900 μm construction
- Offered in OM2, OM3, and OS2
- Available in 6-, 12-, and 24-fiber counts
- Attenuation: OS2 ≤0.39dB/km and OM3/OM4 ≤3.0dB/km
- Nominal Diameters: 6F = 5.7mm, 12F = 6.2mm, and 24F = 8.5mm

## INDOOR DISTRIBUTION LOW-SMOKE ZERO HALOGEN

- Ideal for LAN backbone and premises wiring
- Flame-retardant thermoplastic jacket
- Tight-buffered, 900 μm construction
- Offered in OM2, OM3, and OS2
- Available in 6-, 12-, and 24-fiber counts
- Attenuation: OS2 ≤0.39dB/km and OM3/OM4 ≤3.0dB/km
- Nominal Diameters: 6F = 5.5mm, 12F = 6.5mm, and 24F = 8mm

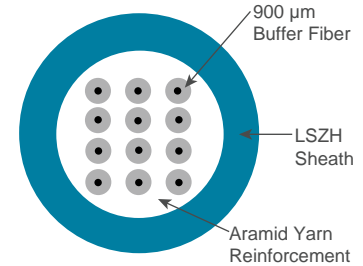
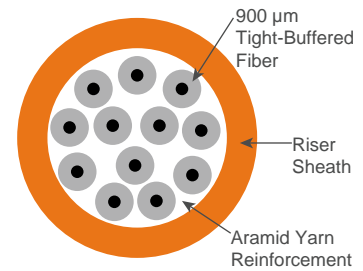

AVAILABLE IN THESE REGIONS\*

### INDOOR DISTRIBUTION RISER-RATED

DESCRIPTION	PART NO.	CANADA	LATIN AMERICA	EUROPE	AFRICA	MIDDLE EAST	INDIA	ASIA
OM2 Indoor Distribution Cable, Riser Rated, 6-fiber, orange, 1 kilometer spool	2D1-50DRR-061	x	x					x
OM2 Indoor Distribution Cable, Riser Rated, 12-fiber, orange, 1 kilometer spool	2D2-50DRR-121	x	x					x
OM2 Indoor Distribution Cable, Riser Rated, 24-fiber, orange, 1 kilometer spool	2D3-50DRR-241	x	x					x
OM3 Indoor Distribution Cable, Riser Rated, 6-fiber, aqua, 1 kilometer spool	2D1-5LDRR-061	x	x					x
OM3 Indoor Distribution Cable, Riser Rated, 12-fiber, aqua, 1 kilometer spool	2D2-5LDRR-121	x	x					x
OM3 Indoor Distribution Cable, Riser Rated, 24-fiber, aqua, 1 kilometer spool	2D3-5LDRR-241	x	x					x
OS2 Indoor Distribution Cable, Riser Rated, 6-fiber, yellow, 1 kilometer spool	2D1-SMDRR-061	x	x					x
OS2 Indoor Distribution Cable, Riser Rated, 12-fiber, yellow, 1 kilometer spool	2D2-SMDRR-121	x	x					x
OS2 Indoor Distribution Cable, Riser Rated, 24-fiber, yellow, 1 kilometer spool	900-SMDRR-241	x	x					x

### INDOOR DISTRIBUTION LSZH

<b>[A]</b> OM2 Indoor Distribution Cable, LSZH, 6-fiber, orange, 1 kilometer spool	2D1-50DRZ-041			x	x	x	x	
OM2 Indoor Distribution Cable, LSZH, 12-fiber, orange, 1 kilometer spool	2D2-50DRZ-061			x	x	x	x	
OM2 Indoor Distribution Cable, LSZH, 24-fiber, orange, 1 kilometer spool	2D3-50DRZ-121			x	x	x	x	
OM3 Indoor Distribution Cable, LSZH, 4-fiber, aqua, 1 kilometer spool	2D1-5LDRZ-041			x	x	x	x	
OM3 Indoor Distribution Cable, LSZH, 6-fiber, aqua, 1 kilometer spool	2D4-5LDRZ-061			x	x	x	x	
OM3 Indoor Distribution Cable, LSZH, 12-fiber, aqua, 1 kilometer spool	2D2-5LDRZ-121			x	x	x	x	
<b>[B]</b> OM3 Indoor Distribution Cable, LSZH, 24-fiber, aqua, 1 kilometer spool	2D3-5LDRZ-241			x	x	x	x	
OS2 Indoor Distribution Cable, LSZH, 2-fiber, yellow, 1 kilometer spool	9D5-SMDRZ-021			x	x	x	x	
OS2 Indoor Distribution Cable, LSZH, 6-fiber, yellow, 1 kilometer spool	2D7-SMDRZ-061			x	x	x	x	
OS2 Indoor Distribution Cable, LSZH, 8-fiber, yellow, 1 kilometer spool	900-SMDRZ-081			x	x	x	x	
OS2 Indoor Distribution Cable, LSZH, 12-fiber, yellow, 1 kilometer spool	2D8-SMDRZ-121			x	x	x	x	
OS2 Indoor Distribution Cable, LSZH, 24-fiber, yellow, 1 kilometer spool	2D9-SMDRZ-241			x	x	x	x	

\* = For all regions not indicated, orders may incur additional lead times, minimum order quantities, and additional charges. Please consult with inside sales. OM4 is also available upon request. Please consult with inside sales. See Spec Sheets for additional information, available online at [www.leviton.com/ns](http://www.leviton.com/ns). Information subject to change. Please consult [leviton.com/cable](http://leviton.com/cable) or contact inside sales for current listing.



# CABLE | Indoor/Outdoor Central Loose Tube Fiber Cable

## INDOOR/OUTDOOR CENTRAL LOOSE TUBE ARMOR

- Ideal for outdoor direct burial, tunnels, and conduits
- Corrugated steel tape armoring and black MDPE sheath
- Offered in OM2, OM3, and OS2
- Available in 6-, 12-, and 24-fiber counts
- Attenuation: OS2  $\leq 0.39$ dB/km and OM3/OM4  $\leq 3.0$ dB/km
- Nominal Diameters: 6F = 8.5mm, 12F = 8.5mm, and 24F = 9.5mm

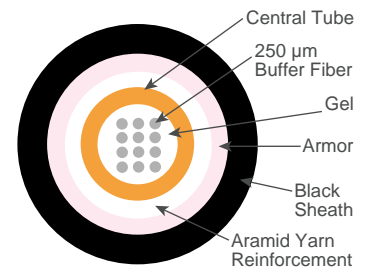

## INDOOR/OUTDOOR CENTRAL LOOSE TUBE LOW-SMOKE ZERO HALOGEN

- Ideal for LAN backbones, telecom access lines, campus networks, and FTTx drops
- 1.5 mm LSZH sheath
- Offered in OM2, OM3, and OS2
- Available in 6-, 12-, and 24-fiber counts
- Attenuation: OS2  $\leq 0.39$ dB/km and OM3/OM4  $\leq 3.0$ dB/km
- Nominal Diameters: 6F = 7.5mm, 12F = 7.5mm, and 24F = 8mm

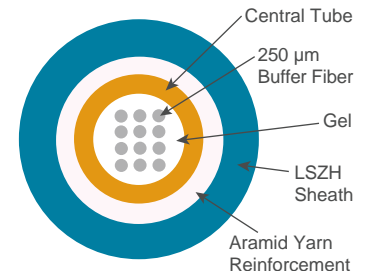

AVAILABLE IN THESE REGIONS\*

INDOOR/OUTDOOR CENTRAL LOOSE TUBE ARMOR		CANADA	LATIN AMERICA	EUROPE	AFRICA	MIDDLE EAST	INDIA	ASIA
DESCRIPTION	PART NO.							
OM2 Indoor/Outdoor Central Loose Tube Armor Cable, MDPE, 6-fiber, black, 2 kilometer spool	2D1-50LAZ-062			x	x	x	x	
OM2 Indoor/Outdoor Central Loose Tube Armor Cable, MDPE, 12-fiber, black, 2 kilometer spool	2D2-50LAZ-122			x	x	x	x	
OM2 Indoor/Outdoor Central Loose Tube Armor Cable, MDPE, 24-fiber, black, 2 kilometer spool	900-50LAZ-242			x	x	x	x	
OM3 Indoor/Outdoor Central Loose Tube Armor Cable, MDPE, 6-fiber, black, 2 kilometer spool	2D1-5LLAZ-062			x	x	x	x	
OM3 Indoor/Outdoor Central Loose Tube Armor Cable, MDPE, 12-fiber, black, 2 kilometer spool	2D2-5LLAZ-122			x	x	x	x	
OS2 Indoor/Outdoor Central Loose Tube Armor Cable, MDPE, 4-fiber, black, 2 kilometer spool	1DA-SMLAZ-042			x	x	x	x	
OS2 Indoor/Outdoor Central Loose Tube Armor Cable, MDPE, 6-fiber, black, 2 kilometer spool	2D1-SMLAZ-062			x	x	x	x	
OS2 Indoor/Outdoor Central Loose Tube Armor Cable, MDPE, 8-fiber, black, 2 kilometer spool	1DC-SMLAZ-082			x	x	x	x	
OS2 Indoor/Outdoor Central Loose Tube Armor Cable, MDPE, 12-fiber, black, 2 kilometer spool	2D2-SMLAZ-122			x	x	x	x	
OS2 Indoor/Outdoor Central Loose Tube Armor Cable, MDPE, 24-fiber, black, 2 kilometer spool	2D3-SMLAZ-242			x	x	x	x	
OS2 Indoor/Outdoor Central Loose Tube Armor Cable, MDPE, 48-fiber, black, 2 kilometer spool	900-SMLAZ-482			x	x	x	x	
INDOOR/OUTDOOR CENTRAL LOOSE TUBE LSZH								
OM2 Indoor/Outdoor Central Loose Tube Armor Cable, LSZH, 6-fiber, green, 1 kilometer spool	2D1-50LRZ-061			x	x	x	x	
OM2 Indoor/Outdoor Central Loose Tube Armor Cable, LSZH, 12-fiber, green, 1 kilometer spool	2D2-50LRZ-121			x	x	x	x	
OM3 Indoor/Outdoor Central Loose Tube Armor Cable, LSZH, 6-fiber, green, 1 kilometer spool	2D1-5LLRZ-061			x	x	x	x	
OM3 Indoor/Outdoor Central Loose Tube Armor Cable, LSZH, 12-fiber, green, 1 kilometer spool	2D2-5LLRZ-121			x	x	x	x	
OS2 Indoor/Outdoor Central Loose Tube Armor Cable, LSZH, 4-fiber, green, 1 kilometer spool	900-SMLRZ-041			x	x	x	x	
OS2 Indoor/Outdoor Central Loose Tube Armor Cable, LSZH, 6-fiber, green, 1 kilometer spool	2D1-SMLRZ-061			x	x	x	x	
OS2 Indoor/Outdoor Central Loose Tube Armor Cable, LSZH, 8-fiber, green, 1 kilometer spool	901-SMLRZ-081			x	x	x	x	
OS2 Indoor/Outdoor Distribution Cable, LSZH, 12-fiber, green, 1 kilometer spool	2D2-SMLRZ-121			x	x	x	x	

\* = For all regions not indicated, orders may incur additional lead times, minimum order quantities, and additional charges. Please consult with inside sales. OM4 is also available upon request. Please consult with inside sales. See Spec Sheets for additional information, available online at [www.leviton.com/ns](http://www.leviton.com/ns). Information subject to change. Please consult [leviton.com/cable](http://leviton.com/cable) or contact inside sales for current listing.

# COPPER SOLUTIONS



SECTION

A

## SECTION A CONTENTS

### COPPER SYSTEMS

- A3** eXtreme® CAT 6A UTP System
- A5** eXtreme CAT 6+ UTP System
- A6** GigaMax® CAT 5e+ UTP System
- A7** Shielded Connectivity Systems
- A8** e2XHD Patching System
- A9** QuickPort® Data & A/V Solutions
- A10** Multimedia Outlet System

### PATCH PANELS

- A11** Introduction
- A12** Selection Guide
- A13** Flat Metal 110-Style
- A14** Flat C1 Ultra Composite
- A15** Flat Metal QuickPort
- A16** Angled 110-Style & QuickPort
- A17** Recessed-Flat & Angled 110-Style & QuickPort
- A18** e2XHD Patching System
- A19** VertiGO® Zero-U QuickPort & Opt-X®
- A20** Telco Data & Voice Grade Panels/Labeling Solutions

### CROSS CONNECT

- A21** Introduction
- A22** CAT 6A & 6 110-Style Wiring Products
- A23** CAT 5e 110-Style Wiring Products
- A25** 110-Style Wiring Cable Management
- A26** 66 Blocks & Accessories

### PATCH CORDS & CABLE ASSEMBLIES

- A27** Introduction
- A28** CAT 6A/6/5e Patch Cords
- A30** MTO & Special Order
- A31** Pre-Terminated Trunks
- A33** Secure RJ System

### CATEGORY-RATED CONNECTORS

- A35** Introduction
- A36** QuickPort UTP Highlighted Features
- A37** UTP QuickPort Connectors
- A39** UTP USOC QuickPort Connectors & Connector Adapter Bezels
- A40** Shielded QuickPort Connectors

### A/V CONNECTIVITY

- A41** Introduction
- A42** A/V Connectors & Adapters
- A45** Multimedia Outlet System

### WALLPLATES & HOUSINGS

- A47** Introduction
- A48** QuickPort Wallplates
- A51** QuickPort Decora® Inserts & Floor Box Assemblies
- A52** Renu® Wallplates & Inserts
- A53** QuickPort Boxes, Modules & Accessories
- A55** DuraPort® Industrial Connectivity
- A57** 86 mm x 86 mm Int'l Wallplates & Inserts
- A59** Telephone & Video Wallplates & Inserts
- A61** Round Telephone Inserts & Surface-Mount Boxes
- A62** Telephone Wall-Phone Jacks
- A63** Decora Wallplates
- A64** Duplex, Round Opening & Blank Wallplates

### COPPER TOOLS & LABELING

- A65** Introduction
- A66** Punchdown, Termination & Test
- A68** Labeling Solutions

## COPPER SYSTEMS | CAT 6A



### EXTREME® CAT 6A UTP SYSTEM

The eXtreme CAT 6A UTP System delivers exceptional electrical performance and superior flexibility to meet 10GBASE-T Ethernet requirements in any environment. Component-rated connectors, patch panels, and cords support server to switch applications in server rows for data center, financial, health care, government, education, transportation, or other demanding applications. Best of all, Leviteon offers a limited lifetime product and performance warranty on certified CAT 6A installations.

- Independently verified and guaranteed by Intertek (ETL) to exceed ANSI/TIA-568-C.2 component, permanent link, and channel margins, and IEEE 10GBASE-T (802.3an) requirements, as well as the ISO/IEC 11801 2nd Edition, CAT 6A component, and Class E<sub>A</sub> standard
- Guaranteed permanent link electrical performance at distances as short as 10 feet, with approved cable
- Triple-stage compensation with multiple patented design features enhances permanent link and channel margin performance and suppresses alien crosstalk (AXT)
- AXT field testing not required with approved cables
- Backward compatible with CAT 6 and 5e systems, 1GBASE-T and 100BASE-T applications
- Provides a seamless migration path to 10GBASE-T performance to maximize return on infrastructure investment (ROI<sup>ii</sup>)
- Limited lifetime warranty on qualified installations

### CAT 6A INDEPENDENT 3RD PARTY (ETL) TEST RESULTS

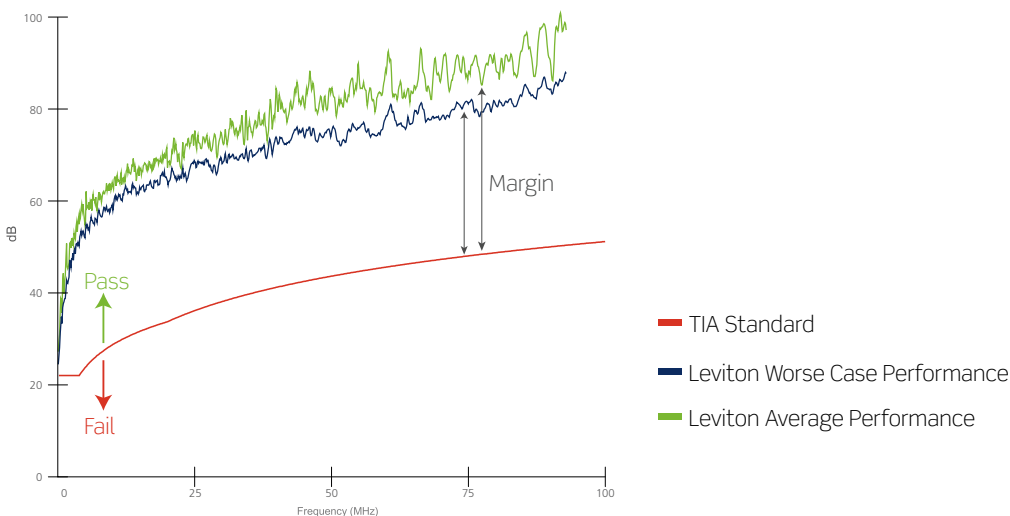

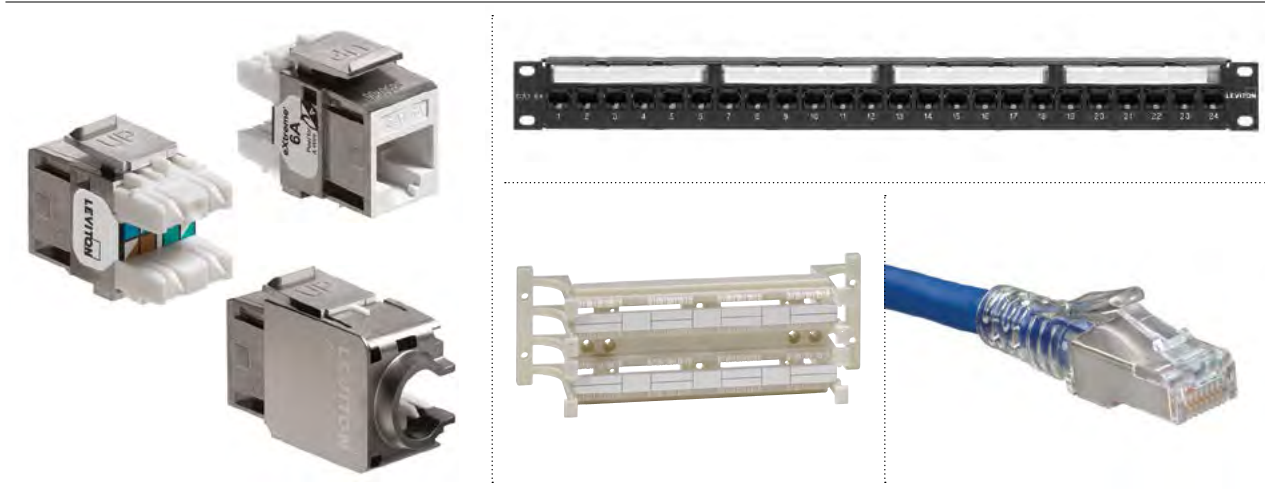

## EXTREME® CAT 6A QUICKPORT® CONNECTORS

(See page A37)

**All eXtreme 6A connectors deliver ease-of-use and superior performance:**

- Patented Cone of Silence® helps suppress AXT
- Patented Retention Force Technology (RFT) protects against damage from 4- or 6-pin plugs
- Pair Separation Towers facilitate quick, effective termination
- Patented dual-layer T568A and T568B label with larger wiring diagrams

**eXtreme 6A component-rated UTP connector adds several exclusive performance-enhancing features:**

- Exceed all ANSI/TIA-568-C.2 component requirements
- Exceed ISO/IEC 11801 2nd Edition CAT 6A component standard
- Metalized body helps suppress AXT
- Patented triple-stage compensation enhances margin performance and augments AXT suppression
- Conductor retention feature that holds wires during termination speeds installation

## EXTREME CAT 6A SLIMLINE PATCH CORDS

(See pages A28-A29)

- Exceed all ANSI/TIA-568-C.2 component requirements
- FTP construction provides excellent AXT suppression
- Strain-relief boot ensures long-term network performance
- SlimLine plug profile reduces congestion in higher-density applications
- Snagless and ergonomic boot design prevents tab breakage during moves, adds, and changes
- Stranded 26-gauge construction provides maximum flexibility

## EXTREME CAT 6A PATCH PANELS

(See pages A11-A16)

- Exceed all ANSI/TIA-568-C.2 component requirements
- Inline IDC fields are consistent with 110-style panel designs
- Designed to work with CAT 6A cables and help to identify first-pair position, it is a true 110 design, providing easier punchdown, improved reliability, and consistent termination
- Patented isolation gap on circuit board minimizes alien crosstalk (AXT) between ports
- Conductor retention feature keeps pairs in place during termination
- Pair Separation Towers facilitate quick, effective termination
- CAT 6A-compatible QuickPort patch panels are available in standard metal or C1 Ultra composite construction
- QuickPort metal panels support density up to 48 ports in 1RU

## EXTREME CAT 6A 110-STYLE WIRING BLOCK KIT

(See page A22)

- Supports high-frequency data signals up to 500 MHz
- Can be used as a consolidation point (CP) in a TIA-defined 90-meter permanent link

For cabling solutions,  
visit [leviton.com/cable](http://leviton.com/cable).

## COPPER SYSTEMS | CAT 6

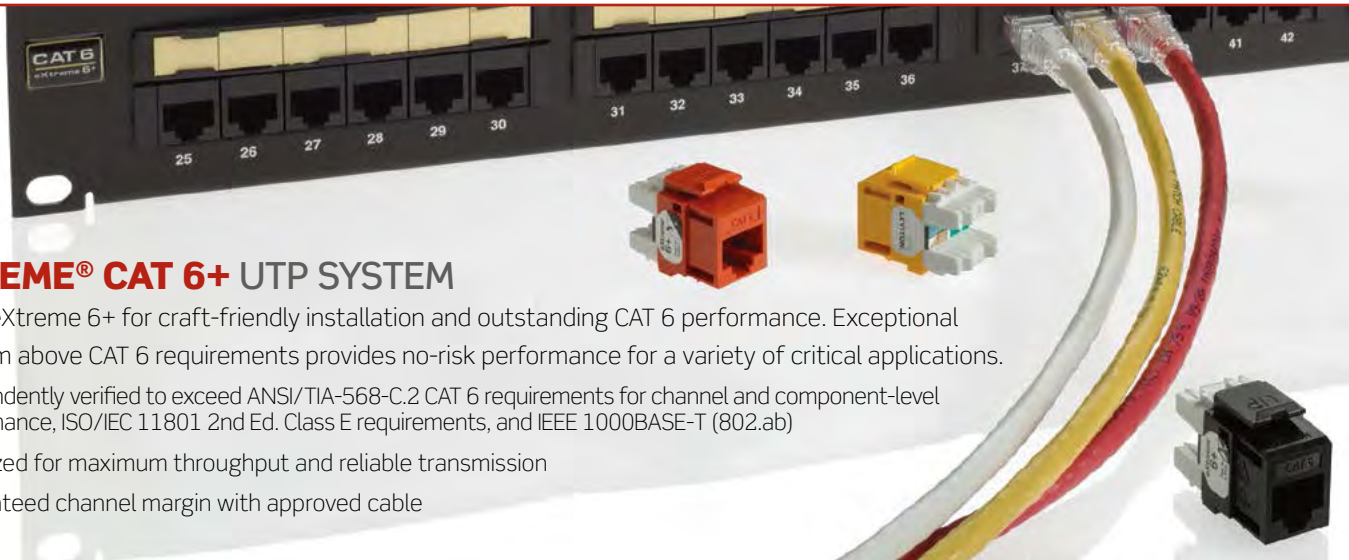

### EXTREME® CAT 6+ UTP SYSTEM

Choose eXtreme 6+ for craft-friendly installation and outstanding CAT 6 performance. Exceptional headroom above CAT 6 requirements provides no-risk performance for a variety of critical applications.

- Independently verified to exceed ANSI/TIA-568-C.2 CAT 6 requirements for channel and component-level performance, ISO/IEC 11801 2nd Ed. Class E requirements, and IEEE 1000BASE-T (802.ab)
- Optimized for maximum throughput and reliable transmission
- Guaranteed channel margin with approved cable



#### EXTREME CAT 6+ QUICKPORT® CONNECTORS (see page A38)

- Patented Retention Force Technology protects tines from damage from 4- or 6-pin plugs
- Pair Separation Tower design facilitates quick, effective termination
- Patented dual-layer T568A and T568B wiring label simplifies punchdown and reduces rework
- Increased wire retention reduces tine contact failure caused by cable stress and fatigue
- 110-style rear termination field for easy termination when installed in a wallplate or panel
- Available in bulk packs



#### EXTREME CAT 6+ PATCH PANELS (see pages A13-A17)

- Patented Retention Force Technology protects tines from damage from 4- or 6-pin plugs
- Dual universal T568A and T568B wiring
- ANSI/TIA-606-B compliant labeling for easy port identification
- Numerous 110-style, QuickPort, and C1 Ultra composite flat and angled options to meet any application need



#### EXTREME CAT 6+ 110-STYLE WIRING BLOCKS (see page A22)

- 96- and 288-pair wall-mount options
- 96-, 192-, and 288-pair rack-mount options
- Can be used as a consolidation point (CP)



#### EXTREME CAT 6+ SLIMLINE PATCH CORDS (see pages A29-A30)

- Component-rated for optimal channel performance
- Stranded 24-gauge wire ensures sufficient flex life and long-term integrity
- Standard booted and SlimLine plug options
- SlimLine profile reduces congestion in higher-density applications
- Snagless and ergonomic boot design prevents tab breakage during moves, adds, and changes
- Strain-relief boot ensures long-term network performance

For cabling solutions,  
visit [leviton.com/cable](http://leviton.com/cable).



## GIGAMAX® CAT 5E+ & CAT 5E UTP SYSTEM

- Guaranteed to exceed ANSI/TIA-568-C.2 and ISO/IEC 11801 2nd Ed. Class D CAT 5e requirements for component and channel level performance, and IEEE 1000BASE-T (802.ab)



### GIGAMAX CAT 5E+ & CAT 5E UTP QUICKPORT® CONNECTORS

(see page A38)

Leviton offers two CAT 5e connectors, the GigaMax CAT 5e+ and GigaMax CAT 5e. Both provide 1000BASE-T performance for high-bandwidth applications. Connectors are available individually or in bulk packs. GigaMax CAT 5e+ connectors include exclusive performance-enhancing features:

- Component rated for optimal channel performance
- Patented Retention Force Technology protects tines from damage from 4- or 6-pin plugs
- Pair Separation Towers facilitate quick, effective termination
- Patented dual-layer T568A and T568B wiring label simplifies punchdown and reduces rework



### GIGAMAX CAT 5E+ PATCH PANELS

(see pages A13-A17)

- Patented Retention Force Technology protects tines from damage from 4- or 6-pin plugs
- Universal T568A and T568B wiring
- ANSI/TIA-606-B compliant labeling for easy port identification
- Numerous 110-style, QuickPort, and C1 Ultra composite flat and angled options to meet any application need



### CAT 5E 110-STYLE WIRING BLOCKS

(see page A23-24)

- 100-, 200-, and 300-pair rack-mount options
- Can be used as a consolidation point (CP)



### CAT 5E SLIMLINE PATCH CORDS

(see pages A29-A30)

- Component rated for optimal channel performance
- Stranded 24-gauge wire ensures sufficient flex life and long-term integrity
- Standard booted and congestion-reducing SlimLine plug options
- Snagless and ergonomic boot design prevents tab breakage during moves, adds, and changes
- Strain-relief boot ensures long-term network performance

For cabling solutions, visit [leviton.com/cable](http://leviton.com/cable).

# COPPER SYSTEMS | Shielded

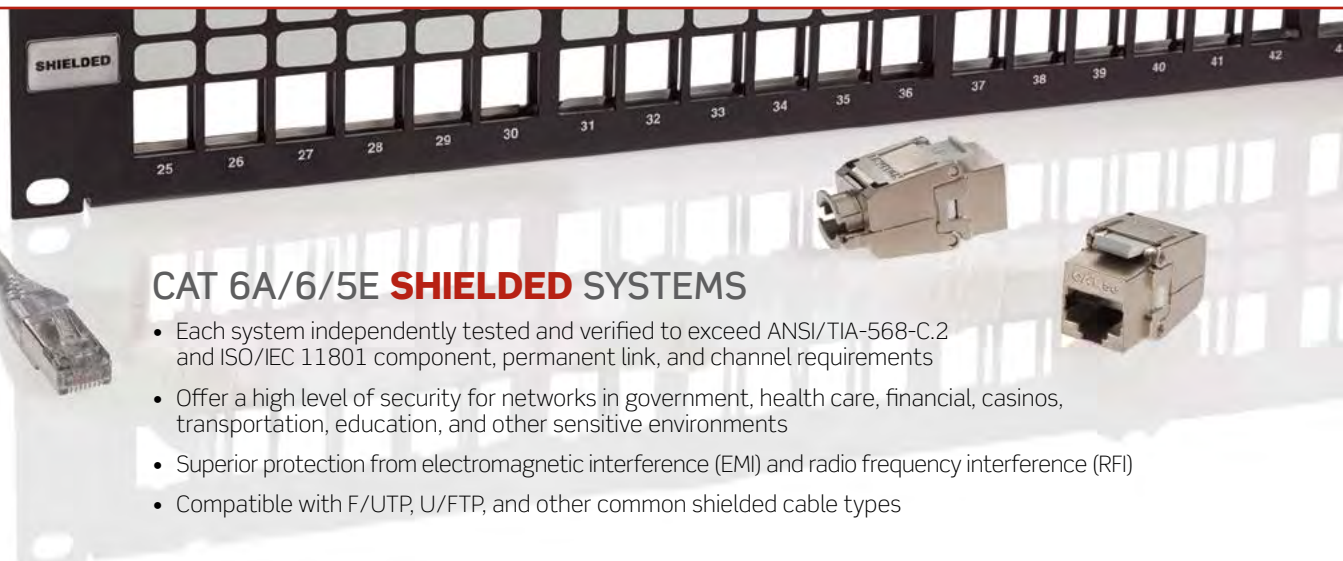

## CAT 6A/6/5E SHIELDED SYSTEMS

- Each system independently tested and verified to exceed ANSI/TIA-568-C.2 and ISO/IEC 11801 component, permanent link, and channel requirements
- Offer a high level of security for networks in government, health care, financial, casinos, transportation, education, and other sensitive environments
- Superior protection from electromagnetic interference (EMI) and radio frequency interference (RFI)
- Compatible with F/UTP, U/FTP, and other common shielded cable types



New

### CAT 6A/6/5E SHIELDED CONNECTORS (see page A40)

- Robust die-cast housing
- Unique design requires no punchdown tool
- 270° hinge for easy access and termination
- Meet ANSI/TIA-568-C.2 component requirements and exceed ISO/IEC 11801 2nd Edition



### CAT 6A/6/5E SHIELDED PATCH PANELS (see pages A15-A16)

- Meet ANSI/TIA-568-C.2 and ISO/IEC 11801
- Stainless-steel "comb" maintains consistent ground path between connector and panel
- 24-port 1RU and 48-port 2RU flat and angled profiles
- Accept all shielded QuickPort® connectors



New

### CAT 6A/6/5E SHIELDED PATCH CORDS (see pages A28-A29)

- Cable construction provides data security and EMI/RFI protection
- Stranded conductors provide longer flex life
- Snagless boot design prevents tab breakage during moves, adds, and changes
- Strain-relief boot ensures long-term network performance

For cabling solutions, visit [leviton.com/cable](http://leviton.com/cable).

## SPOTLIGHT

## High-Density Shielded Solutions



**High-density shielded solutions** offer an exceptional level of data security and EMI/RFI protection for government, health care, gaming, manufacturing, and other sensitive environments. With shielding, internal data signals are securely contained and isolated from interference, providing superior alien crosstalk (AXT) suppression. Additionally, up to six connectors fit in a single-gang wallplate to support high-density applications.





## e2XHD COPPER & FIBER PATCHING SYSTEM

An easy-to-connect, high-density solution for enterprise and data center applications, where fast deployment and simple maintenance is critical. It includes 1RU and 4RU high-density panels, copper and fiber snap-in cassettes, and accessories for additional cable protection and management. The e2XHD cassettes quickly snap in and pull out of the panels, making installation, moves, adds, and changes easier than ever. See pages B27-B30 for e2XHD Fiber Patching System.

- High-density panels allow patching for up to 48 copper ports in a 1RU panel or 192 ports in a 4RU panel
- System accessories include rear cable managers, blank cassette inserts, angled panel covers, and cable clamp kits



Copper Cassette and eXtreme® CAT 6 or CAT 6A QuickPort Connectors

### e2XHD COPPER CASSETTE KIT (see page A18)

- Used exclusively with e2XHD high-density panels
- QuickPort® connectors snap into cassette after termination, sold separately
- AXT barrier reduces alien crosstalk between ports
- Cassettes are also available pre-terminated on Leviton trunk cables Make-to-Order (MTO) program



### 1RU AND 4RU HIGH-DENSITY PANELS (see page A18)

- Hold up to 48 copper ports per rack unit
- Accept up to 8 copper cassettes per RU
- Mount on standard 19" relay racks or cabinets
- Flat and angled e2XHD panels available

For cabling solutions, visit [leviton.com/cable](http://leviton.com/cable).



### SIMPLE INSTALLATION AND REMOVAL

- Alignment tabs on rear of patch panel make cassette insertion easy
- To remove cassette from panel, simply pull out handle using release latch; no tools required
- Rear cable manager supports both copper and fiber cables, and includes cable management rings and tie downs

### e2XHD PATCHING SYSTEM VIDEO



Watch the training video at [leviton.com/videos](http://leviton.com/videos): "e2XHD Patching System for Data Center Networks."

# COPPER SYSTEMS | QuickPort® Data, Voice & A/V Solutions

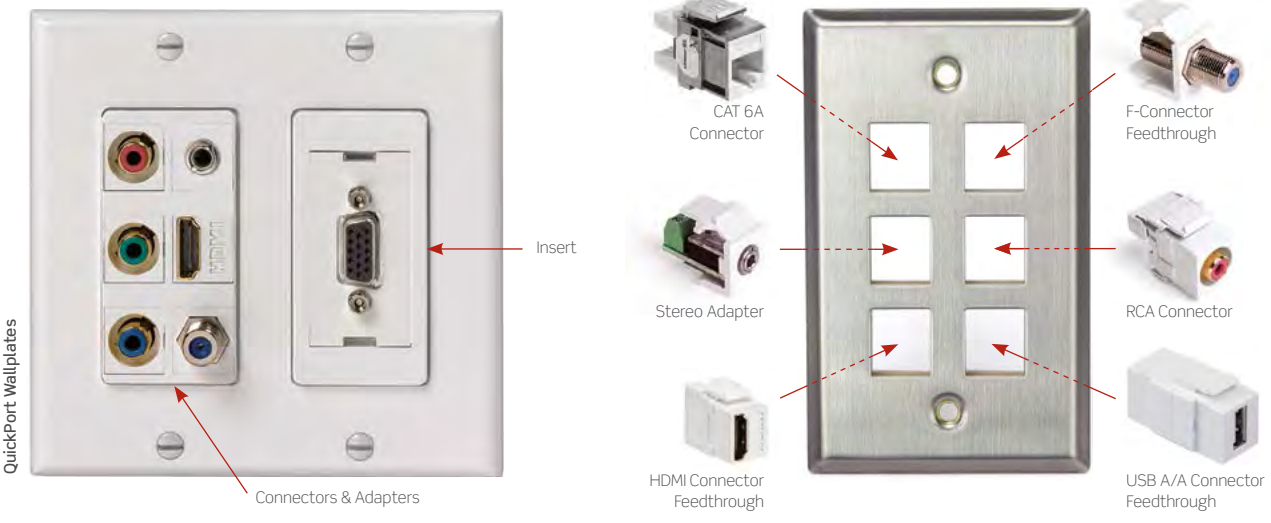

## QUICKPORT DATA, VOICE & AUDIO/VIDEO SOLUTIONS

The QuickPort System, our exclusive set of patch panels, connectors, wallplates, and surface-mount boxes, allows you to create the perfect mix of voice, data, video, and audio. Connectors sold separately, available on pages A37-A43.

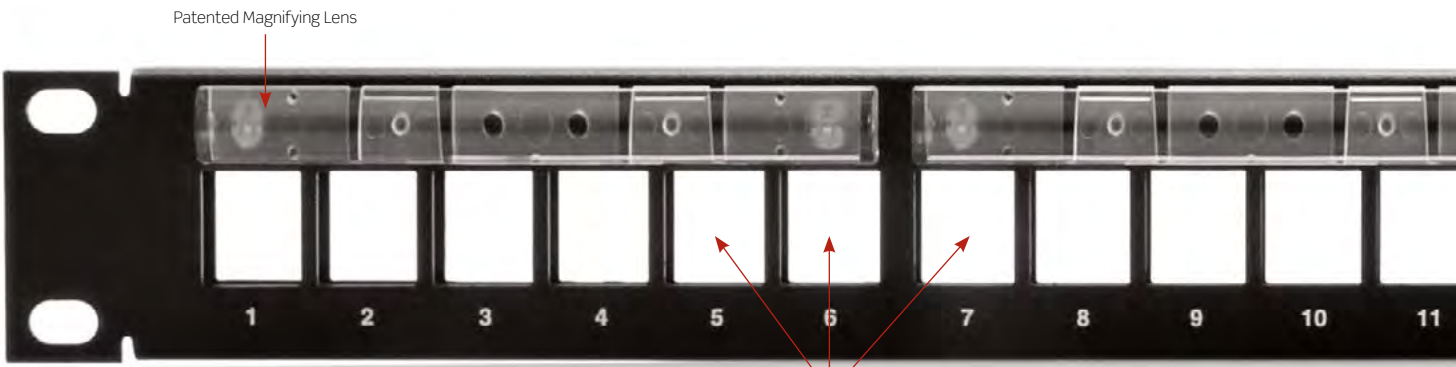

### QUICKPORT PATCH PANELS

Choose from an amazing selection of QuickPort patch panels, including shielded, high-density, recessed for close quarters, ultra-strong composite, and two styles of angled panels. Vertigo® Zero-U QuickPort panels support up to 12 ports per panel and can mount in virtually any type of installation.

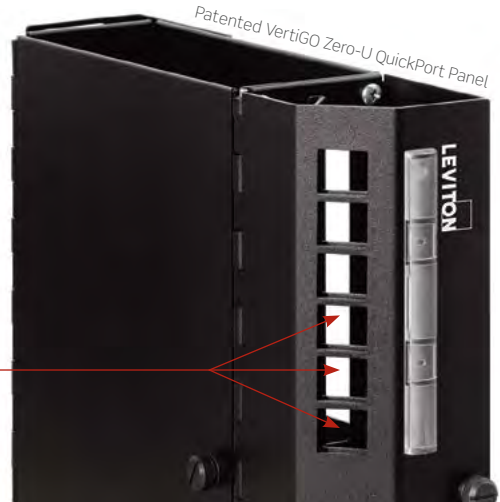

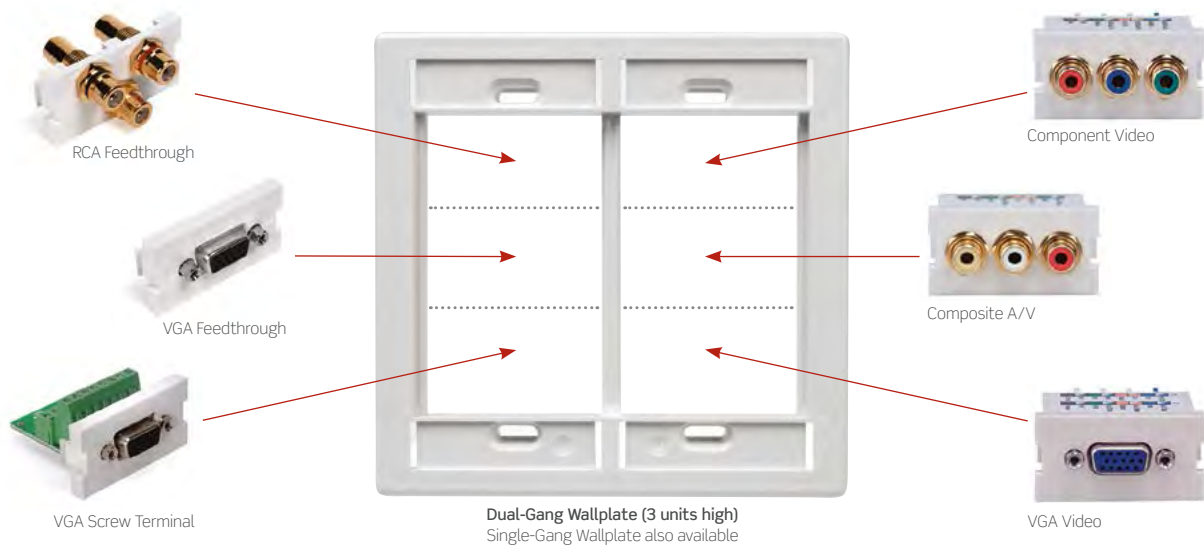

## MULTIMEDIA OUTLET CONFIGURATIONS

The highly flexible front-loading Multimedia Outlet System (MOS) and QuickPort® Solutions work together to provide hundreds of possible configurations. Select MOS, MOS and QuickPort, or QuickPort only configurations. For more information about configuring your MOS installation, visit [leviton.com/MOS](http://leviton.com/MOS). Find the complete line of copper and fiber MOS solutions on pages A45-A46 and B65-B66.

### QUICKPORT ADAPTER MODULES

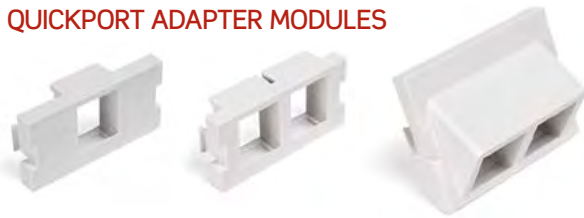

### MOS MODULES WILL ALSO WORK WITH DECORA® WALLPLATES:

Just snap one-unit-high modules into Decora inserts.

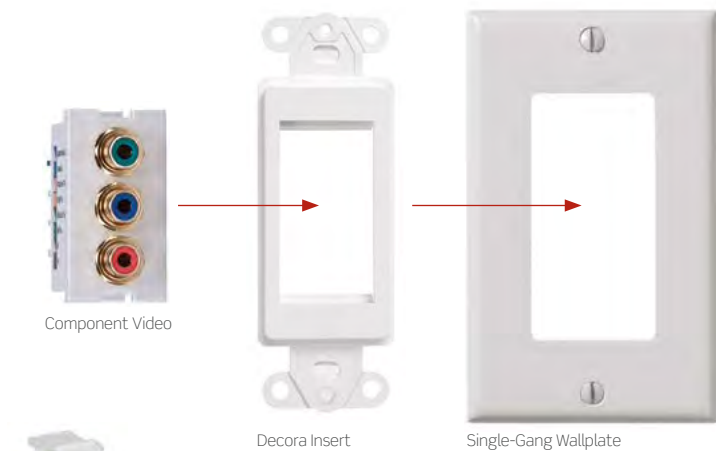

To see the complete line of fiber adapters see page B64.



# 8023

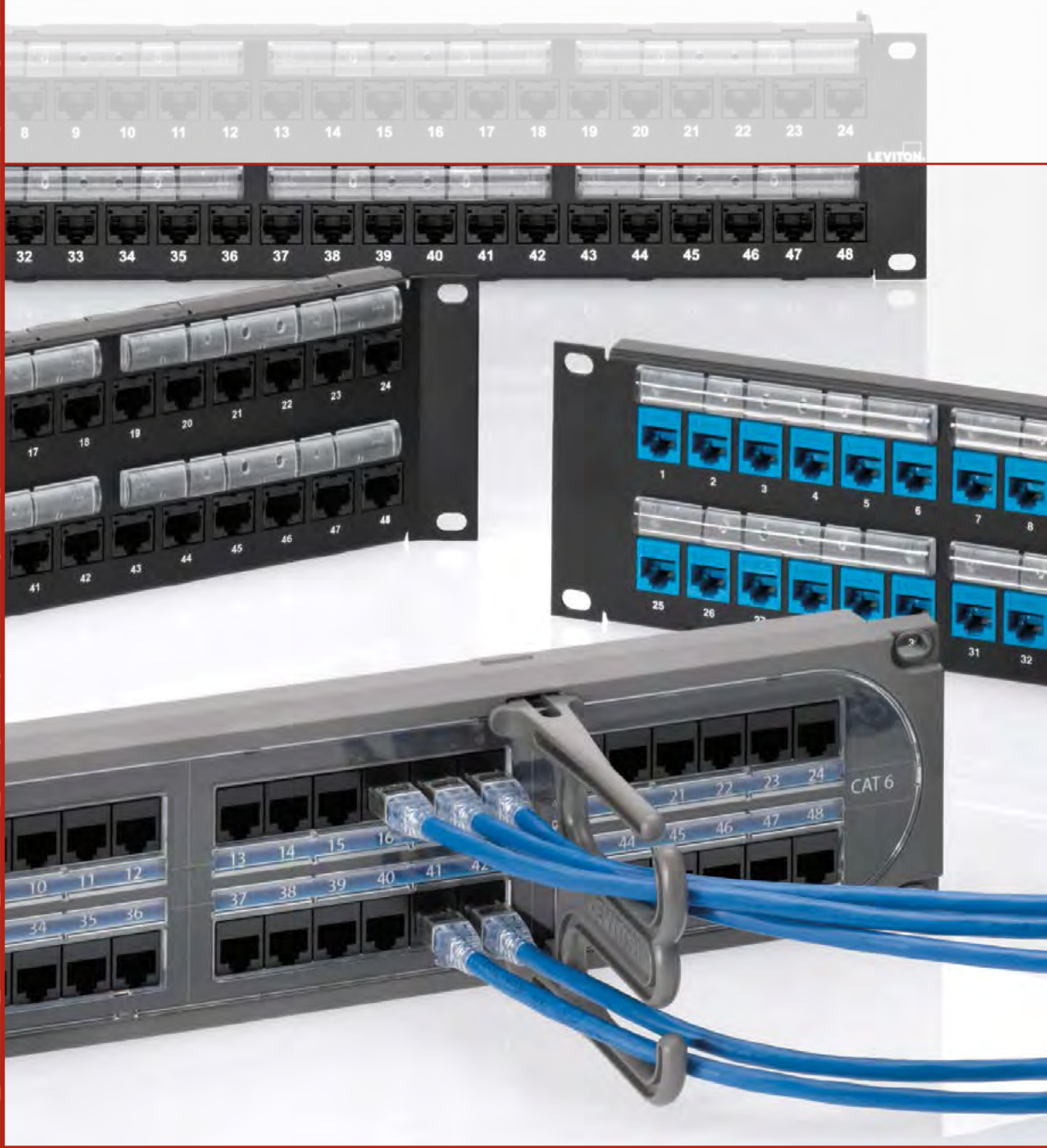

## FEATURED PRODUCTS

CAT 6A 110-Style Patch Panels **A13**

C1 Ultra-Composite Patch Panels **A14**

1RU 48-Port QuickPort® High-Density Flat & Angled Panels **A15-A17**

e2XHD Patching System **A18**

## patch panels

Choose Leviton for all your patch panel needs. Our new e2XHD high-density panels make patching easier than ever, using snap-in copper and fiber cassettes. Other popular styles include the 1RU 48-port UTP, component-rated CAT 6A 110-style, and the C1 Ultra with customizable face and composite construction. Additional UTP and shielded panels, the patented Zero-U Vertigo®, die-cast high-density panels, recessed panels for close quarters, and two styles of angled panels round out the industry's largest selection of patch panels.

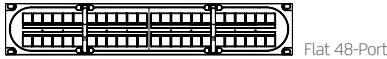

## FLAT COMPOSITE PATCH PANELS | A14

Leviton C1 Ultra panels have the same profile as standard metal panels, but feature polymer composite construction. Customizable faces are ideal for data centers, telecommunication rooms, and other showroom-style environments.

**Available Styles:** 110-Style | QuickPort® | Blank

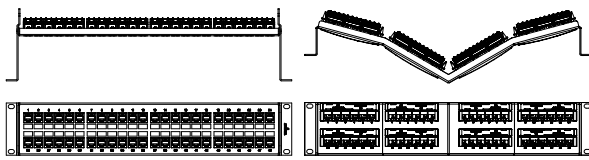

Recessed-Flat 48-Port

Recessed-Angled 48-Port

## RECESSED PATCH PANELS | A17

Designed primarily for data center cabinet applications, recessed-flat and angled panels are ideal where a low-profile appearance and minimal depth in front of the panel is required.

**Available Styles:** 110-Style | QuickPort

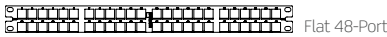

## e2XHD PATCH PANELS | A18

These high-density panels are designed for data center applications where fast deployment and simple maintenance is important. They accept both fiber and copper e2XHD cassettes.

**Available Styles:** Flat | Angled

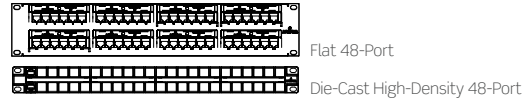

## FLAT STANDARD PATCH PANELS | A13-A15

Traditional, flat profile works well in almost any application. Most flat panels include rear cable management bars.

**Available Styles:** 110-Style | QuickPort | Shielded

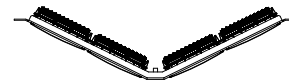

## ANGLED PATCH PANELS | A16

Recommended for use in racks to optimize patch cord management and rack space utilization.

**Available Styles:** 110-Style | QuickPort | Shielded

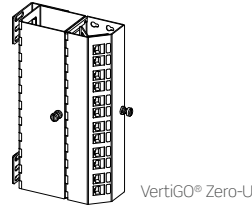

## ZERO-U PATCH PANELS | A19

VertiGO panels are recommended for use in data center cabinets, or for any application that needs connectivity outside of the traditional 19" rack space. Vertical channel models provide cable routing and protection.

**Available Styles:** QuickPort | Opt-X®



## The Industry's Best Service & Support

### DARBY BRENNAN

Senior Technical Support Representative

Darby has nine years of experience providing outstanding technical support, developing tools and initiatives to assist customers, representatives, and distributors in using Leviton products. She has been integral in the creation and launch of the Leviton ez-Cross tool and the Connected Home worksheet. Both projects, developed in response to direct customer feedback, have successfully optimized the custom ordering process.

# PATCH PANELS | Flat Metal 110-Style > UTP

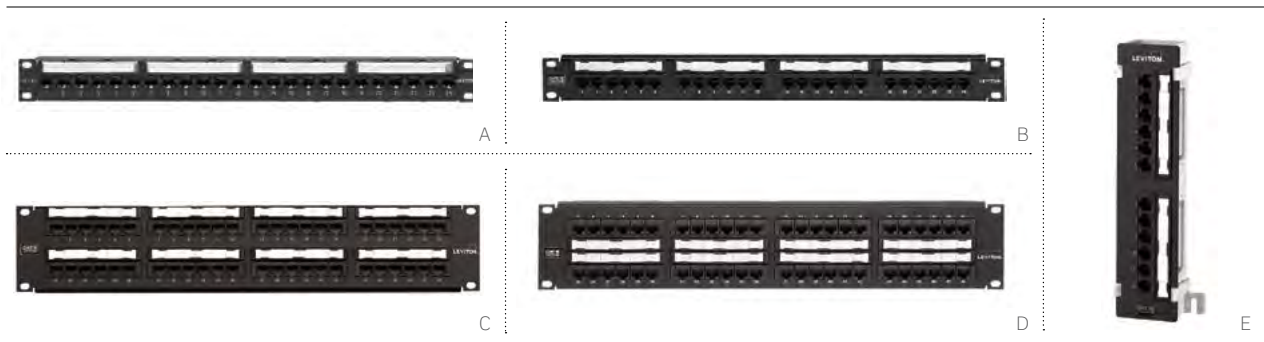

## FLAT UTP COMPONENT-RATED 110-STYLE PATCH PANELS

- 1RU 12- or 24-port, 2RU 48-port, and 4RU 96-port configurations
- Available in CAT 6A, 6, and 5e
- 6-port RJ-45 modules on front, and 110-style punchdowns on rear
- Include color codes for T568A and B wiring schemes
- CAT 5e and 6 include 25-pair wiring schemes
- Rear cable management bar included with panels (one bar per 24 ports)
- CAT 6A panels include patented magnifying lens label holders for easy reading
- Silk-screened port numbers and paper label holders included
- Independently tested and verified by Intertek (ETL) to meet all TIA component, permanent link, and channel requirements
- Patented Retention Force Technology (RFT) protects against damage from 4- or 6-pin plugs

## AVAILABLE CABLE MANAGEMENT:

See Section C for product details and ordering information.

Versi-Duct®

Rear Cable Management Bars

Horizontal Cable Managers

Blank Filler Panels

VELCRO® Brand Fasteners



49005-CMB included with all CAT 6A/6/5e flat panels.

FLAT 110-STYLE PATCH PANELS & PATCH BLOCK			
DESCRIPTION	CAT 6A	CAT 6	CAT 5E
1RU 12-Port Flat 110-Style Patch Panel	—	69586-U12	5G596-U12
1RU 24-Port Flat 110-Style Patch Panel	<b>[A]</b> 6A586-U24	<b>[B]</b> 69586-U24	5G596-U24
2RU 48-Port Flat 110-Style Patch Panel	6A586-U48	<b>[C]</b> 69586-U48	5G596-U48
2RU 48-Port Flat 110-Style Patch Panel, central labeling	—	<b>[D]</b> 69586-C48	5G596-C48
4RU 96-Port Flat 110-Style Patch Panel	—	69586-U96	5G596-U96
12-Port 110-Style Patch Block, 89D bracket	—	<b>[E]</b> 69586-U89	5G596-U89

## SPOTLIGHT CAT 6A Component-Rated 110-Style Patch Panels

Leviton CAT 6A 110-style patch panels offer ANSI/TIA-568-C.2 performance up to 500 MHz to support 10GBASE-T networks. The panels have a physical design consistent with industry-standard 110-style panels, including in-line configured IDCs and 6-port housing modules. In addition, they add several exclusive design features:

- Patented Retention Force Technology (RFT) protects against damage from 4- or 6-pin plugs
- Pair Separation Tower design makes untwisting CAT 6A pairs easier
- Separated IDC fields simplify identifying first cable-pair position
- Conductor retention feature holds conductors securely in place during termination
- Triple-stage compensation with patented design features enhances permanent link and channel performance

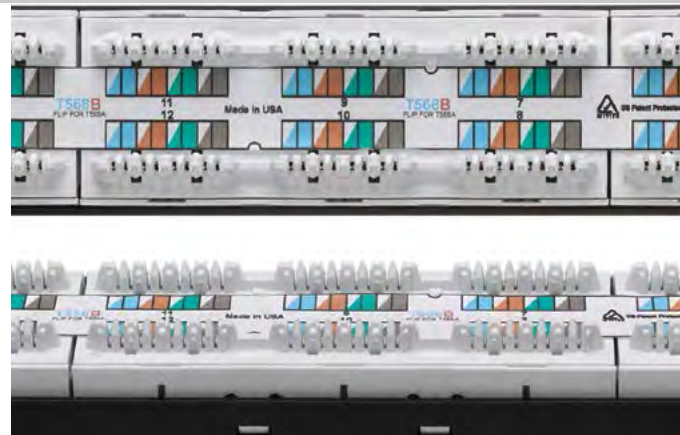

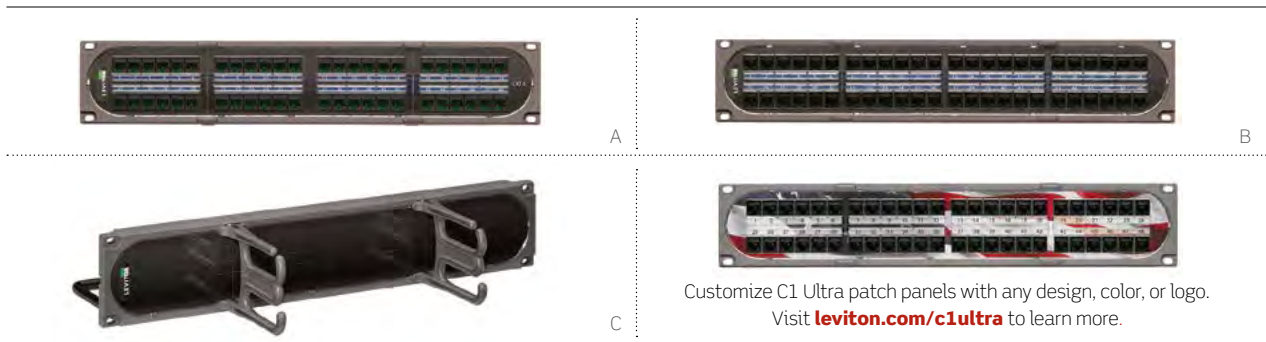

Customize C1 Ultra patch panels with any design, color, or logo. Visit [leviton.com/c1ultra](http://leviton.com/c1ultra) to learn more.

## C1 ULTRA FLAT COMPOSITE UTP 110-STYLE AND QUICKPORT® PATCH PANELS

- Industry's first polymer construction
- Made from high-tech composite materials for a look unique in the patch panel market
- 10% stronger than standard 16-gauge metal patch panels, providing added support during termination of 110-style panels
- Stylish look and customizable face make panels ideal for showroom-style environments
- Panel face can be customized to feature any design, color, or logo
- Available in 48-port 2RU QuickPort and 110-style models
- Include two integrated patch cord managers that attach directly to the face of the panel, saving up to 50% of valuable rack space
- Patch cord managers prevent cables from obstructing view of port numbers
- Include two rear cable management bars
- Clear label holders create a window to easily view port numbers and custom designs
- Panel is 100% recyclable

## AVAILABLE CABLE MANAGEMENT:

See Section C for product details and ordering information.

Versi-Duct®

Rear Cable Management Bars

Horizontal Cable Managers

Blank Filler Panels

VELCRO®

Brand Fasteners



Front & Rear Managers are included with all C1 Ultra panels.



Watch the training video at [leviton.com/videos](http://leviton.com/videos): "C1 Ultra Composite Patch Panel."

### FLAT COMPOSITE 110-STYLE & QUICKPORT PATCH PANELS

DESCRIPTION	CAT 6	CAT 5E	EMPTY
2RU 48-Port Flat Composite 110-Style Panel	[A] C1686-U48	C1586-U48	—
2RU 48-Port Flat Composite QuickPort Panel	—	—	[B] C1255-H48
2RU Blank Panel / Cable Manager	—	—	[C] C1253-2CM

## SPOTLIGHT C1 Ultra Patch Panels



**C1 Ultra patch panels combine strength and durability** with unique style and customizable faces, providing a uniform look when installed with Opt-X Ultra® Fiber Enclosures and Versi-Duct Cable Managers.

- Under applied force tests, the panel was 10% stronger than standard 16 AWG metal patch panels
- Panels come kitted with two patch cord managers that attach directly to the panel face, saving up to 50% of rack or cabinet space and reducing obstruction of center label
- Clear label holders create a "window" to easily view centralized port numbers and custom designs

# PATCH PANELS | Flat Metal QuickPort® > UTP & Shielded

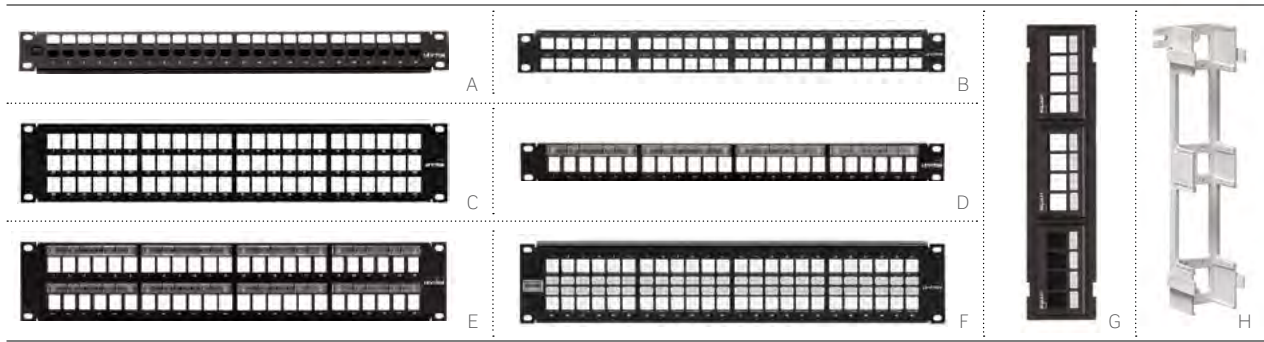

The QuickPort system, our exclusive set of mix-and-match panels, connectors, wallplates, and surface-mount boxes, allows you to create the perfect mix of voice, data, video, and audio, all in a single panel. Connectors sold separately, available on pages A37-A43.

### FLAT TRADITIONAL PATCH PANELS

- Standard-density 24- and 48-port panels are available with white blocks or patented magnifying lens label holder
- Silk-screened port numbers on panel front

### FLAT HIGH-DENSITY PATCH PANELS

- Panels maximize rack space and reduce costs in high-density applications
- 1RU 48-port panel available in standard (stamped) or patented, robust die-cast aluminum
- Standard 2RU 72-port panel also available

### FLAT SHIELDED PATCH PANELS

- Shielding protects against electromagnetic interference (EMI) and radio frequency interference (RFI), and provides excellent alien crosstalk (AXT) suppression
- Provide data security for government, financial, and other sensitive networks
- Include star washers and grounding lug
- Accept all shielded QuickPort connectors

### AVAILABLE CABLE MANAGEMENT:

See Section C for product details and ordering information.

Versi-Duct®

Rear Cable Management Bars

Horizontal Cable Managers

Blank Filler Panels

VELCRO® Brand Fasteners



49005-CMB included with all CAT 6A/6/5e flat panels, unless otherwise noted.

FLAT QUICKPORT PATCH PANELS, PATCH BLOCKS & ACCESSORIES				
DESCRIPTION	CAT 6A	CAT 6	CAT 5E	EMPTY
1RU 24-Port Flat QuickPort Patch Panel	[A] 6910G-U24‡	69270-U24‡	5G270-U24‡	49255-H24‡
1RU 48-Port Flat QuickPort Patch Panel, cable management bar sold separately	—	—	—	[B] 49255-Q48
1RU 48-Port Flat Die-Cast QuickPort Patch Panel	—	69270-D48*	5G270-D48*	49255-D48*
2RU 48-Port Flat QuickPort Patch Panel	6910G-U48	69270-U48	5G270-U48	49255-H48
2RU 72-Port Flat QuickPort Patch Panel	—	—	—	[C] 49255-D72
1RU 24-Port Flat QuickPort Patch Panel, magnifying lens holder	—	—	—	[D] 49255-L24‡
2RU 48-Port Flat QuickPort Patch Panel, magnifying lens holder	—	—	—	[E] 49255-L48
1RU 24-Port Flat Shielded QuickPort Patch Panel	—	—	—	4S255-S24‡
2RU 48-Port Flat Shielded QuickPort Patch Panel	—	—	—	[F] 4S255-S48
12-Port QuickPort Patch Block, mounting bracket sold separately, 10" H x 2.375" W	—	—	—	[G] 49255-Q89
12-Port QuickPort Patch Block, extra deep, mounting bracket included, 10" H x 2.375" W	—	—	—	47689-OQP
QuickPort Patch Block 89D Mounting Bracket	—	—	—	[H] 40089-00D

\* = 49005-CMB, rear cable manager not included.

‡ = Intact™ Intelligent Port Management ready (see Section E).

CAT 6A/6/5e patch panels are kitted with black 6A10G, 61110, or 5G110 connectors.



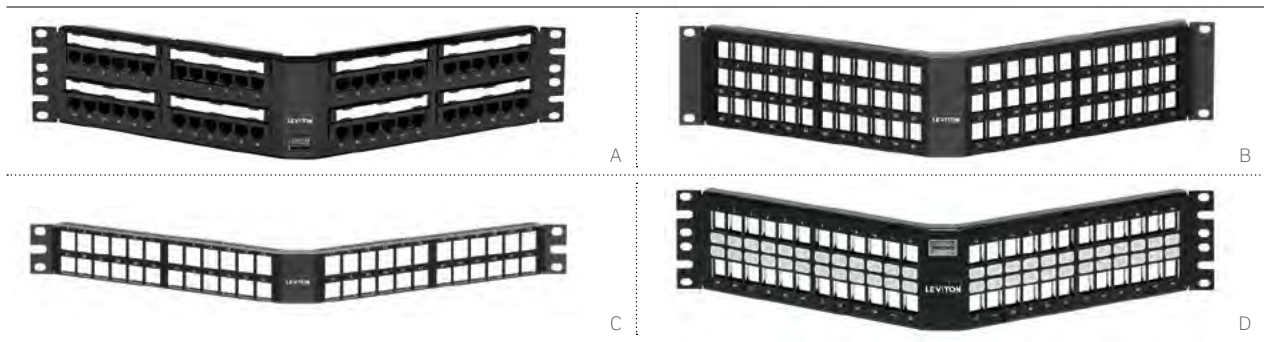

Angled patch panels are ideal for 19" rack applications, offering easy termination and improved patch cord routing. For cabinet applications, recessed-angled panels (page A17) are recommended to meet minimal front depth requirements.

### ANGLED UTP 110-STYLE & QUICKPORT PATCH PANELS

- Conserve rack space by routing patch cords directly into vertical cable management
- Angled design facilitates proper bend radius and simplifies termination
- 110-style angled panels are available in CAT 6A, 6, and 5e
- 110-style angled panels include a snap-in plastic label holder and card stock labels
- QuickPort angled panels include white write-on blocks
- 1RU 48-port QuickPort panel can be used with all QuickPort connectors including CAT 6A, 6, 5e, fiber, and A/V
- CAT 6A panels include patented magnifying lens label holders for easy reading
- All QuickPort angled panels sold empty

### ANGLED SHIELDED PATCH PANELS

- Provide excellent alien crosstalk (AXT) suppression
- Shielding protects against electromagnetic interference (EMI) and radio frequency interference (RFI), and provides excellent alien crosstalk (AXT) suppression
- Provide data security for government, financial, medical, gaming, and other sensitive networks
- Include star washer and grounding lug
- Available in QuickPort 1RU 24-port and 2RU 48-port angled configurations
- Accept all shielded CAT 6A, 6, and 5e QuickPort connectors

### AVAILABLE CABLE MANAGEMENT:

See Section C for product details and ordering information.

Versi-Duct®

Rear Cable Management Bars

Horizontal Cable Managers

Blank Filler Panels

Transitional Covers

VELCRO®

Brand Fasteners



49006-AMB Recommended angled rear cable management bar



49254-BC1 Recommended angled transitional cover

### ANGLED 110-STYLE & QUICKPORT PATCH PANELS

DESCRIPTION	CAT 6A	CAT 6	CAT 5E	EMPTY
1RU 24-Port Angled 110-Style Patch Panel	6A587-U24	—	—	—
2RU 48-Port Angled 110-Style Patch Panel	6A587-U48	<b>[A]</b> 69587-U48	5G597-U48	—
1RU 24-Port Angled QuickPort Patch Panel	—	—	—	49256-H24
2RU 48-Port Angled QuickPort Patch Panel	—	—	—	49256-H48
2RU 72-Port Angled QuickPort Patch Panel	—	—	—	<b>[B]</b> 49256-D72
1RU 48-Port Angled High-Density QuickPort Patch Panel	—	—	—	<b>[C]</b> 49256-D48
1RU 24-Port Angled Shielded QuickPort Patch Panel	—	—	—	4S256-S24
2RU 48-Port Angled Shielded QuickPort Patch Panel	—	—	—	<b>[D]</b> 4S256-S48

QuickPort Connectors are available on pages A37-A43.

PATCH PANELS | Recessed-Flat & Angled 110-Style & QuickPort® > UTP



Recessed-flat patch panels are a great option for rack and cabinet installations with minimal front depth, and where rear cabinet doors are in close proximity to the back rail.

**RECESSED-FLAT 110-STYLE & QUICKPORT PATCH PANELS**

- 3" recessed design allows improved access and maintains proper cable bend radius
- All recessed-flat panels include a screwless cable management bar that fastens directly to the back of the panel
- Recessed-flat 110-style panels include patented magnifying lens label holders for easy reading
- All QuickPort recessed-flat panels sold empty

**RECESSED-ANGLED 110-STYLE & QUICKPORT PATCH PANELS**

- Conserve rack space by routing patch cords directly into vertical cable management
- Recessed depth facilitates proper bend radius
- Unique dual-angled design greatly improves punchdown accessibility
- Recessed-angled 110-style panels include a snap-in plastic label holder and card stock labels

**AVAILABLE CABLE MANAGEMENT:**

See Section C for product details and ordering information.

- Versi-Duct®
- Rear Cable Management Bars
- Horizontal Cable Managers
- VELCRO® Brand Fasteners



**RECESSED-FLAT 110-STYLE & QUICKPORT PATCH PANELS**

DESCRIPTION	CAT 6	CAT 5E	EMPTY
1RU 24-Port Recessed-Flat 110-Style Panel	<b>[A]</b> 69586-R24	5G596-R24	—
2RU 48-Port Recessed-Flat 110-Style Panel	<b>[B]</b> 69586-R48	5G596-R48	—
1RU 24-Port Recessed-Flat QuickPort Panel	—	—	<b>[C]</b> 49255-R24
2RU 48-Port Recessed-Flat QuickPort Panel	—	—	<b>[D]</b> 49255-R48

**RECESSED-ANGLED 110-STYLE & QUICKPORT PATCH PANELS**

2RU 48-Port Recessed-Angled 110-Style Panel	<b>[E]</b> 6W587-U48	5W597-U48	—
1RU 24-Port Recessed-Angled QuickPort Panel	—	—	4W256-H24
2RU 48-Port Recessed-Angled QuickPort Panel	—	—	4W256-H48
2RU 72-Port Recessed-Angled QuickPort Panel	—	—	<b>[F]</b> 4W256-D72

QuickPort connectors are available on pages A37-A43.



Patented magnifying lens label holders improve label visibility.

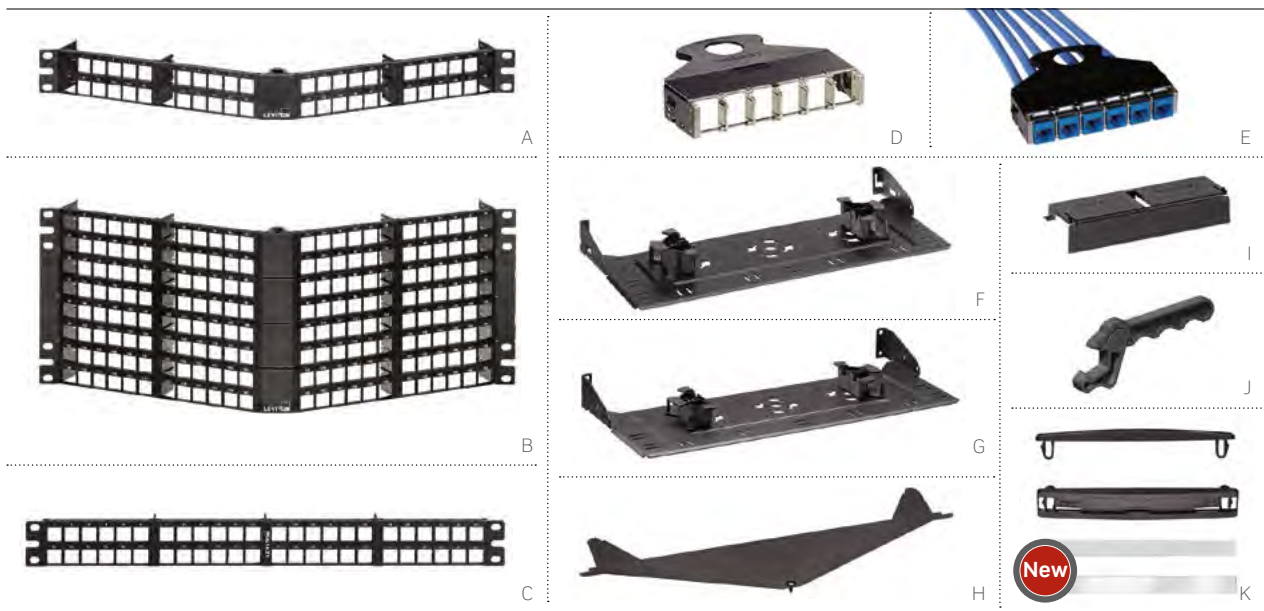

The e2XHD Patching System provides simple termination and improved cable routing for copper and fiber applications. The system includes 1RU and 4RU panels, copper and fiber snap-in cassettes, and accessories for additional cable protection and management. The e2XHD cassettes quickly snap in and pull out of the high-density angled panel, making installation, moves, adds, and changes easier than ever. Copper cassettes are available either on pre-terminated trunks or with field-terminated connectors. Panel covers and blank cassettes offer extra protection from dust and damage.

- Panels allow mix-and-match of Leviton fiber and copper snap-in cassettes
- Copper cassettes are available either on pre-terminated trunks (see [leviton.com/configurator](http://leviton.com/configurator)) or kitted with field-terminated eXtreme® CAT 6A or CAT 6 connectors
- Copper connectors easily snap into cassette after termination
- System accessories include rear cable managers, blank cassette inserts for unused cassette openings, and a cover for the angled panel, minimizing dust or debris
- Rear Cable Manager includes four ¼" fiber storage rings

## e2XHD PATCHING SYSTEM

DESCRIPTION	PART NO.
<b>[A]</b> 1RU e2XHD Angled High-Density Panel	E2X1A-D48
<b>[B]</b> 4RU e2XHD Angled High-Density Panel	E2X4A-192
<b>[C]</b> 1RU e2XHD Flat High-Density Panel	E2X1F-D48
4RU e2XHD Flat High-Density Panel	E2X4F-192
<b>[D]</b> 6-port e2XHD Cassette, empty*	E2XHD-BRK
<b>[E]</b> e2XHD Copper Cassette, terminated to trunk cable	configure online at <a href="http://leviton.com/e2XHD">leviton.com/e2XHD</a>
<b>[F]</b> e2XHD Rear Cable Manager for Angled Panel, with fiber storage rings (four ¼" rings)	E2XHD-CMB
<b>[G]</b> e2XHD Rear Cable Manager for Flat Panel, with fiber storage rings (four ¼" rings)	E2X1F-CMB
<b>[H]</b> e2XHD Angled Panel Cover	E2XHD-COV
<b>[I]</b> e2XHD Cassette Blank	E2XHD-BLK
<b>[J]</b> QuickPort® Connector Removal Tool	E2XHD-JRT
<b>[K]</b> e2XHD Label Kit (4 pack)*	E2XHD-LBL

e2XHD Patching System for fiber applications on pages B29-B30.

\* = QuickPort connectors sold separately (see pages A37-A43).

+ = Label kit occupies one row of panel.

# PATCH PANELS | VertiGO® Zero-U QuickPort® & Opt-X®

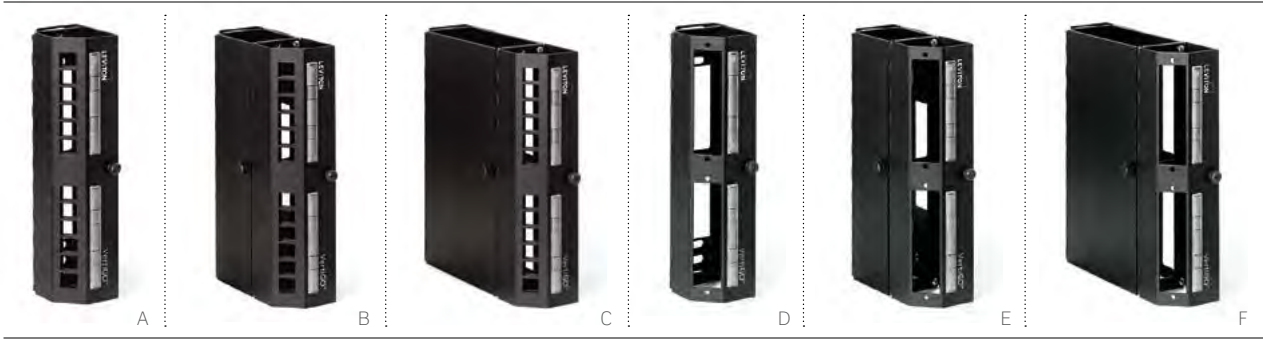

## VERTIGO ZERO-U QUICKPORT & OPT-X PATCH PANELS

- Patented innovative design for multiple applications (see right)
- Zero-U uses no rack space
- All styles sold empty, with either QuickPort or Opt-X style openings
- Low-profile design fully covers connections
- Improve cabinet center airflow by routing rear cable along outer edges
- Styles with 3" and 6" channels provide additional cable management space
- Hinged doors provide easy access to termination field
- Patented magnifying lens label holders facilitate easy reading
- Support copper and fiber installations

## RECOMMENDED APPLICATIONS:

- Any Size Cabinet
- Ladder Tray
- Wire Basket
- Raised-Floor Enclosure
- Modular Furniture
- Wall-Mount

### VERTIGO ZERO-U PATCH PANELS

DESCRIPTION	EMPTY
[A] 12-Port QuickPort VertiGO Panel, panel only	49280-QP0
[B] 12-Port QuickPort VertiGO Panel, 3" channel	49280-QP3
[C] 12-Port QuickPort VertiGO Panel, 6" channel	49280-QP6
[D] Opt-X Adapter Plate VertiGO Panel, panel only	49280-AP0
[E] Opt-X Adapter Plate VertiGO Panel, 3" channel	49280-AP3
[F] Opt-X Adapter Plate VertiGO Panel, 6" channel	49280-AP6

Contact Inside Sales at 800.722.2082 for custom VertiGO configurations .  
 QuickPort connectors are available on pages A37-A43.  
 Opt-X adapter plates are available on pages B21-B22.  
 Channel not available separately.

### VERTIGO ZERO-U VIDEO



Watch the training video at [leviton.com/videos](http://leviton.com/videos): "How to Mount Leviton's VertiGO Patch Panel."

See page B20 for additional specialized fiber applications.

## SPOTLIGHT VertiGO Zero-U Patch Panels > Unparalleled Flexibility

Patented VertiGO Zero-U Patch Panels offer unprecedented versatility for a wide range of installations. In data centers where left- or right-side cabinet installation is ideal, VertiGO can share mounting hardware with servers or other existing equipment. Where traditional cabinet space is lacking, VertiGO can be mounted to a ladder tray, wire basket, directly to the wall, under a raised floor, or even onto modular furniture.

VertiGO addresses three major data center issues: density, cooling, and appearance. Mounting vertically along a back cabinet rail allows more terminations than would otherwise be possible. Cables can be routed along the cabinet outer edges to improve airflow. The low-profile design fully covers the connections, providing the clean look data center managers seek.



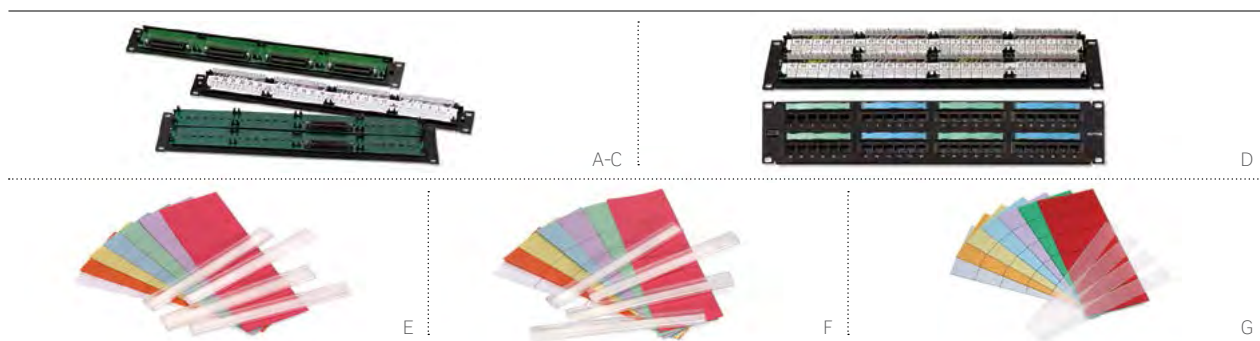

## DATA GRADE PATCH PANELS

- 8P8C Data Grade Panel supports 10/100BASE-T applications
- Feature 25-pair female Amphenol™ RJ-21X connectors
- Pre-configured in 24- and 48-port densities

## VOICE GRADE PATCH PANELS

- 110-style or female 25-pair configurations
- Unique label delineates 1-, 2-, 4-, or 25-pair termination options
- Pre-configured in 24- and 48-port densities
- 25th pair (violet/slate) is not used in 25-pair style panels

## RJ-21X CONNECTORS PER PATCH PANEL

TELCO & VOICE GRADE PANELS		
PART NO.	24-PORT	48-PORT
49012	1	2
49014	2	4
49018	4	8

## PATCH PANEL LABELING SOLUTIONS

Quickly and easily identify ports on your patch panel or patch block for a perfectly organized installation. Universal/110-style labeling kits are used with 12-, 24-, 48-, and 96-port panels. QuickPort® kits are available for 24-, 32-, and 48-port panels. Label holders include adhesive backing for applying directly to patch panel surface. See below for part numbers.

DATA GRADE PATCH PANELS		
DESCRIPTION	1RU 24-PORT	2RU 48-PORT
8P8C Patch Panel, one 25-pair connector per 6 ports (supports 10/100BASE-T), 4 wire-pairs per port	<b>[A]</b> 49018-J24	49018-J48
VOICE GRADE PATCH PANELS		
8P4C Patch Panel, 110 termination, 2 wire-pairs per port	<b>[B]</b> 49013-P24	<b>[D]</b> 49013-P48
8P4C Patch Panel, two 25-pair connectors per 24 ports, 2 wire-pairs per port	49014-J24	<b>[C]</b> 49014-J48
8P2C Patch Panel, one 25-pair connector per 24 ports, 1 wire-pair per port	49012-J24	49012-J48
PATCH PATCH PANEL LABELING SOLUTIONS		
DESCRIPTION	PART NO.	
<b>[E]</b> Adhesive Holder and Labels Kit for QuickPort® Patch Panels (supports 24 ports)	49257-QHD	
<b>[F]</b> Adhesive Holder and Labels Kit for 110-Style Patch Panels (supports 24 ports)	49257-I24	
<b>[G]</b> Designation Kit Replacement for 110-Style Patch Panels (supports 24 ports)	69585-IDL	

# COBALT



## FEATURED PRODUCTS

CAT 6A Wiring Block **A22**

## cross connect

Dependable, flexible, and cost-effective, Leviton 110-style and 66-block cross-connect products are ideal for telecommunications rooms and distribution frames. 110-style wiring blocks are available in CAT 6A, 6, and 5e, and can be mounted to the wall or plywood backboard. Rack-mount solutions are also available.

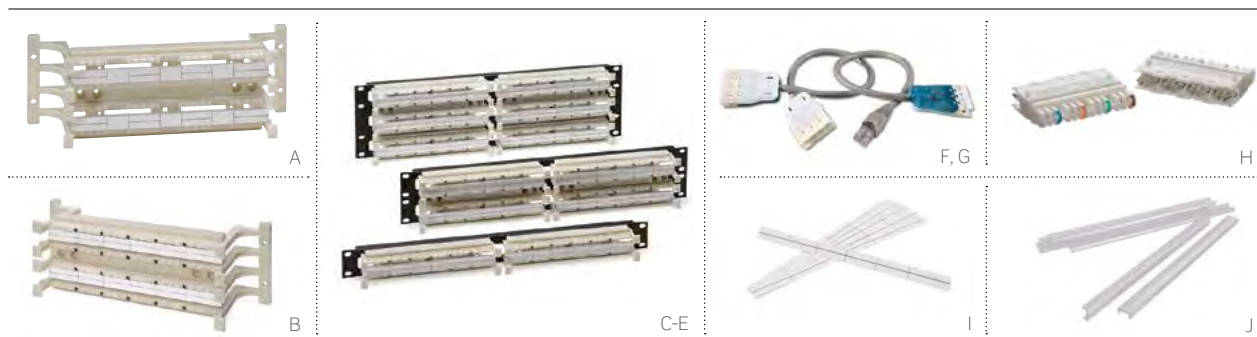

### CAT 6A 110-STYLE WIRING BLOCKS

- Support high-frequency data signals up to 500 MHz
- Can be used as a consolidation point (CP) in a TIA-defined 90-meter permanent link
- Designed to mitigate alien crosstalk (AXT)
- Independently tested and verified by Intertek (ETL) to meet all TIA component, permanent link, and channel requirements
- Available in 64-pair wall-mount block

### CROSS-CONNECT TERMINATION VIDEO



Watch the training video at [leviton.com/videos](http://leviton.com/videos): "110-Style Cross-Connect Termination."

Visit [leviton.com/support](http://leviton.com/support) for detailed termination diagrams.

### CAT 6 110-STYLE WIRING PRODUCTS

- Support voice, data, and security applications
- Complete selection of rack and wall-mount blocks, mounting frames, patch cords, and cable management
- Wall-mount wiring block kits available in 96-, 192-, and 288-pairs
- Rack-mount wiring block kits available in 1RU 96-pair, 2RU 192-pair, and 3RU 288-pair configurations
- 110-style patch cords in 110-110 and 110-T568A/B configurations
- Connector clips withstand 200 re-terminations

### CAT 6A 110-STYLE WALL-MOUNT WIRING BLOCK KITS

DESCRIPTION	64-PAIR
[A] eXtreme® CAT 6A 110-Style Wiring Block, wall mount w/ legs and C-4 clips*	41D6A-1F4

### CAT 6 110-STYLE WIRING BLOCK KITS (W/ C-4 CLIPS)

DESCRIPTION	96-PAIR	192-PAIR	288-PAIR
eXtreme CAT 6+ 110-Style Wiring Block, wall mount w/o legs	41NB6-1F4	—	—
eXtreme CAT 6+ 110-Style Wiring Block, wall mount w/legs*	[B] 41AB6-1F4	—	41AB6-3F4
eXtreme CAT 6+ 110-Style Wiring Block, rack mount	[C] 41DR6-1F4	[D] 41DR6-2F4	[E] 41DR6-3F4

### CAT 6 110-STYLE PATCH CORDS

DESCRIPTION	1-FOOT	2-FOOT	3-FOOT	5-FOOT	7-FOOT	10-FOOT
[F] eXtreme CAT 6+ 110 to 110 Patch Cord	62240-01S	62240-02S	62240-03S	62240-05S	62240-07S	62240-10S
[G] eXtreme CAT 6+ 110 to T568B Patch Cord	6234B-01S	—	6234B-03S	6234B-05S	6234B-07S	6234B-10S

### CAT 6 110-STYLE CONNECTOR CLIPS

DESCRIPTION	PART NO.
[H] CAT 6 C-4 Clips (bag of 10)	69104-IDC

### 110-STYLE LABELING SOLUTIONS

[I] CAT 6 Label Kit, 6/kit	41LBL-60W
[J] Label Holder, 6/kit	41100-HLD

\*CAT 6A/6 110-Style wiring block stand-off legs are non-removable. Legs not sold separately for CAT 6A/6 wiring blocks.

# CROSS CONNECT | 110-Style Wiring Products > CAT 5e



## CAT 5E 110-STYLE WIRING PRODUCTS

- Wall-mount bases available in 50- and 100-pair with or without legs
- 300-pair bases include stand-off legs, labels, and label holders
- Kits include bases, connecting blocks, labels, and holders
- Rack-mount units are for 100-, 200-, and 300-pair densities
- Patch cords in 110-110 and 110-T568A/B configurations

## The Industry's Best Service & Support

**DANIEL UNDERBRINK, RCDD**  
Senior Applications Engineer

As one of our applications engineering experts, Dan acts as the voice of the customer on copper product development teams, ensuring the construction and design of Leviton solutions meet customer needs. Customers also rely on Dan as a technical resource, as he delivers remote and on-site support for customer installations around the world. He's a regular contributor to the Leviton online Knowledgebase, co-authored our popular CAT 6A Reference Guide, and continuously supports contractor certification and international training initiatives.





**CAT 5E 110-STYLE WALL-MOUNT WIRING BLOCK KITS**

DESCRIPTION	C-4 CLIPS	C-5 CLIPS
GigaMax® CAT 5e 110-Style Wall-Mount Wiring Block Kit, w/ legs, 100 pair*	41AB2-1F4	41AB2-1F5
GigaMax CAT 5e 110-Style Wall-Mount Wiring Block Kit, w/o legs, 100 pair	—	41NB2-1F5
GigaMax CAT 5e 110-Style Wall-Mount Wiring Block Kit, w/ legs, 300 pair*	41AB2-3F4	41AB2-3F5

**CAT 5E 110-STYLE WALL-MOUNT WIRING BLOCKS**

DESCRIPTION	50-PAIR	100-PAIR	300-PAIR
GigaMax CAT 5e 110-Style Wall-Mount Wiring Block, w/ legs*	41AW1-050	<b>[B]</b> 41AW2-100	<b>[A]</b> 41AW2-300
GigaMax CAT 5e 110-Style Wall-Mount Wiring Block, w/o legs	41DW1-050	<b>[C]</b> 41DW2-100	—
89D Bracket Compatible Wiring Base UNIT**	41DW1-589	—	—

**CAT 5E 110-STYLE RACK-MOUNT KITS**

DESCRIPTION	C-4 CLIPS	C-5 CLIPS
GigaMax CAT 5e 110-Style Rack-Mount Wiring Block Kit, 100 pair, 1RU	41DBR-1F4	41DBR-1F5
GigaMax CAT 5e 110-Style Rack-Mount Wiring Block Kit, 200 pair, 2RU	41DBR-2F4	41DBR-2F5
GigaMax CAT 5e 110-Style Rack-Mount Wiring Block Kit, 300 pair, 3RU	41DBR-3F4	41DBR-3F5

**CAT 5E 110-STYLE RACK-MOUNT WIRING BLOCKS**

DESCRIPTION	100-PAIR	200-PAIR	300-PAIR
GigaMax CAT 5e 110-Style Rack-Mount Wiring Block	<b>[D]</b> 41DR2-100	<b>[E]</b> 41DR2-200	<b>[F]</b> 41DR2-300

**RACK-MOUNT MANAGER**

DESCRIPTION	PART NO.
Rack-Mount Horizontal Cord Manager	<b>[G]</b> 41D1R-HCM

**CAT 5E 110-STYLE PATCH CORDS**

DESCRIPTION	1-FOOT	2-FOOT	3-FOOT	5-FOOT	7-FOOT	10-FOOT
GigaMax CAT 5e 110 to 110 Patch Cord, 4 pair	<b>[H]</b> 5G240-01S	5G240-02S	5G240-03S	5G240-05S	5G240-07S	5G240-10S
GigaMax CAT 5e 110 to 568A Patch Cord, 4 pair	<b>[I]</b> 5G34A-01S	5G34A-02S	5G34A-03S	5G34A-05S	5G34A-07S	5G34A-10S
GigaMax CAT 5e 110 to 568B Patch Cord, 4 pair	5G34B-01S	5G34B-02S	5G34B-03S	5G34B-05S	5G34B-07S	5G34B-10S

**CAT 5E 110-STYLE CONNECTOR CLIPS**

DESCRIPTION	C-3 CLIPS	C-4 CLIPS	C-5 CLIPS
GigaMax CAT 5e 110-Style Connector Clips (bag of 10)	49103-IDC	<b>[J]</b> 49104-IDC	<b>[K]</b> 49105-IDC
GigaMax CAT 5e 110-Style Connector Clips (bag of 50)	—	49104-I50	—

**CAT 5E 110-STYLE WIRING BLOCK ACCESSORIES**

DESCRIPTION	PART NO.
GigaMax CAT 5e 110-Style legs (2 ea) (for use with 41DW1 only)	410L2-050
GigaMax CAT 5e 110-Style legs (2 ea) (for use with 41DW2 only)	410L2-100
110-Style Horizontal Cord Manager w/o legs	<b>[L]</b> 41D10-HCM
110-Style Horizontal Cord Manager w/ legs*	<b>[M]</b> 41A10-HCM

**110-STYLE LABELING SOLUTIONS**

CAT 5e Label Kit, 6/kit	<b>[N]</b> 41LBL-00W
Label Holder, 6/kit	<b>[O]</b> 41100-HLD

\*CAT 5e 110-style wiring block stand-off legs are non-removable.

\*\*89D Brackets, 40089-00D, sold separately, see page A15.

# CROSS CONNECT | 110-Style Wiring Cable Management



A, B



C, D

## WALL-MOUNT CORD MANAGERS & 110-STYLE PRODUCTS

- Vertical cord managers help route patch cords in high-density applications
- Basic wall-mount unit features 300-pair capacity
- Extension kits add up to 600 extra pairs
- Rear cable channel, side slots, horizontal cord managers, and bottom cable tray included
- Horizontal rack-mount cord organizer available

Basic Mounting Frame Kits include three 100-pair bases, mounting frame, cable tray, connector blocks, three horizontal cord managers, label strip holders, and white label strips.



VERTICAL CORD MANAGERS AND 110-STYLE WALL-MOUNT WIRING PRODUCTS	
DESCRIPTION	PART NO.
<b>[A]</b> 300-Pair Basic Mounting Frame Unit (sheet metal frame and bottom cable tray only)	41MB2-SMF
<b>[B]</b> 300-Pair Extension Mounting Frame Unit (sheet metal frame only)	41MB2-SME
Basic Mounting Frame Kit, three 100-pair bases, mounting frame, cable tray, 75 C-4 connector blocks, three horizontal cord managers, label strip holders, and white label strips	41MB2-3F4
Basic Mounting Frame Kit, three 100-pair bases, mounting frame, cable tray, 60 C-5 connector blocks, three horizontal cord managers, label strip holders, and white label strips	41MB2-3F5
Extension Mounting Frame Kit, three 100-pair bases, mounting frame, 60 C-4 and 12 C-5 connector blocks, three horizontal cord managers, label strip holders, and white label strips	41MB2-EXT
<b>[C]</b> 300-pair Vertical Cord Manager Basic Unit, includes bottom cable tray	41880-300
<b>[D]</b> 300-pair Vertical Cord Manager Extension Unit	41880-EXT

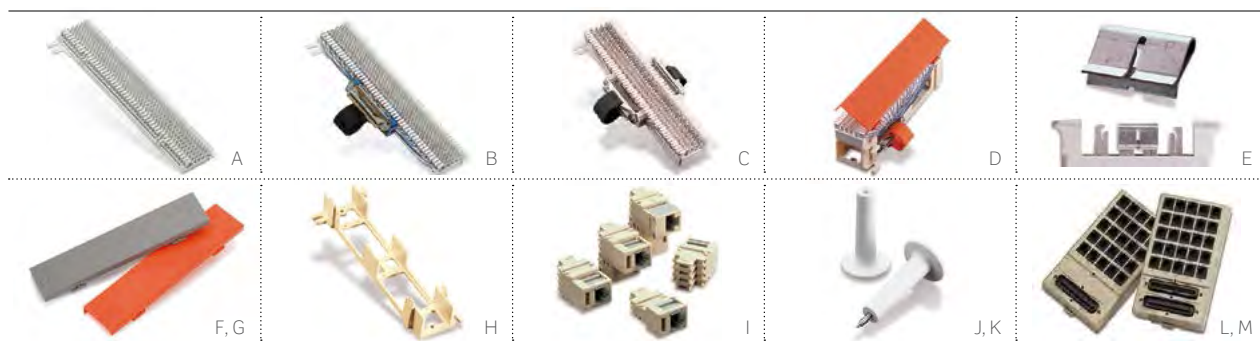

## 66 CONNECTING BLOCKS

- Install individually or in pairs in cross-connect system
- High-impact fire-retardant UL 94V-0 plastic
- Phosphor bronze quick-connect insulation displacement 66-clips
- 25- and split 50-pair styles
- Accessories include covers, brackets, wire distribution spools, adapters, and bridging clips

## SURFACE-MOUNT MINI PATCH PANELS

- Excellent for tight spaces and simple breakout patching
- Combine two or more panels for in-line cross connect
- Use with 25-pair cable assemblies
- Wall mountable

Visit [leviton.com/support](http://leviton.com/support) for detailed termination diagrams.

### 66 CONNECTING BLOCKS

DESCRIPTION	PART NO.
<b>[A]</b> M-Block: 25-pair [66M1-25]* 10" H x 3 5/16" W x 1 3/16" D Split M-Block: 50-pair [66M1-50]* 10" H x 3 5/16" W x 1 3/16" D	40066-M25 40066-M50
<b>[B]</b> M-Block, female connector [66M1-50W]* 10" H x 3 5/16" W x 1 3/16" D	40066-0MW
<b>[C]</b> M-Block, female and male connectors [66M1-50W2]* 10" H x 3 5/16" W x 1 3/16" D	40066-MW2
<b>[D]</b> Connectorized Demarc Block [66M1-50R]* 10" H x 3 13/32" W x 2 3/4" D, female Amphenol™	40066-0MR

### BRIDGING CLIPS

<b>[E]</b> Bridging Clips (SA-1) (50 per package)	40067-0BC
---	-----------

### HINGED COVERS AND SNAP-ON COVERS

Snap-on Cover for M-Blocks: [66MC-4]* 9 15/16" H x 2 15/16" W x 5/16" D	40050-MCV
<b>[F]</b> Hinged Cover for M-Blocks: grey [66MC4LH-G]* 10" H x 2 7/16" W x 3/4" D	40050-MHG
<b>[G]</b> Hinged Cover for Demarc Blocks: orange [66MC4LH-O]* 10" H x 2 7/16" W x 3/4" D	40050-MHO

### BRACKET FOR M BLOCKS AND CONNECTOR MOUNTING

<b>[H]</b> M-Block Bracket for Connector Mounting: [89-D/QuickPort® Blocks]* 10" H x 3 13/32" W x 1 1/2" D	40089-00D
--	-----------

### [I] MODULAR ADAPTERS

2-Position Modular Adapter [Tap-2]* - Converts two 66-clip contacts into 6P2C modular connector	40072-0T2
4-Position Modular Adapter [Tap-4]* - Converts four contacts into 6P4C modular connector	40072-0T4
6-Position Modular Adapter [Tap-6]* - Converts six contacts into 6P6C modular connector	40072-0T6
8-Position Modular Adapter, T568B wiring [Tap™-8]* - Converts eight contacts into 8P8C non-keyed modular connector	40072-0T8

### WIRE DISTRIBUTION SPOOLS

<b>[J]</b> Wire Distribution Spool [20-A]* 1 3/4" Dia. x 3" H	40054-0DS
<b>[K]</b> Wire Distribution Spool with screw [20-B]* 1 3/4" Dia. x 3" H	40054-DSS

### SURFACE-MOUNT MINI PATCH PANELS

<b>[L]</b> 25 6-position 2-Conductor [RJ-11]* FCC Spec Jacks, connected to a circuit board with one male 25-pair connector	41600-00I
<b>[M]</b> 25 6-position 2-Conductor [RJ-11]* FCC Spec Jacks, connected to a circuit board with two bridged 25-pair connectors	41620-00I
Mounting Magnets (20 per package)	49200-00M

\*Numbers in brackets refer to industry product designation.

# COPPER



## patch cords & cable assemblies

Connect data center, telecom room, and work area equipment with Leviton cable assemblies. The Secure RJ System offers lockable cords and trunks for sensitive applications. Copper trunks can be custom ordered in a wide variety of options - including pre-terminated to e2XHD copper cassettes - greatly reducing installation time. Patch cords are available in CAT 6A, 6, and 5e, UTP or shielded, and a variety of lengths and colors.

### FEATURED PRODUCTS

e2XHD Trunks **A32**

Secure RJ System **A33**

# PATCH CORDS & CABLE ASSEMBLIES | CAT 6A Patch Cords > UTP & Shielded



All Leviton patch cords are components of a category-rated network infrastructure solution that includes connectors, patch panels, and approved Leviton partner cabling. For optimum performance and full system warranty, use a Leviton Contractor Program installer to install your Leviton components.



## CAT 6A PATCH CORDS

- Same cord for UTP or shielded installations
- SlimLine cords feature narrow-profile plug for less congestion in high-density applications
- SlimLine cords are independently tested and verified by Intertek (ETL) to meet ANSI/TIA-568-C.2 component requirements
- Standard and LSZH cords are independently tested and verified by Intertek (ETL) to meet ANSI/TIA-568-C.2 channel requirements
- CAT 6A cords provide exceptional alien crosstalk (AXT) suppression in 6A channels
- Strain-relief boot ensures long-term network performance
- Snagless design prevents tab breakage
- Outside diameter of .240" is easier to manage
- 26-gauge stranded cable for maximum flexibility
- Low-Smoke Zero-Halogen (LSZH) cords available
- Leviton patch cord required for channel warranty

### CAT 6A PATCH CORDS

DESCRIPTION	CAT 6A
<b>[A]</b> eXtreme® CAT 6A Component-Rated SlimLine Patch Cord (same cord for UTP or shielded installations)^	6AS10-xx*
<b>[B]</b> eXtreme CAT 6A Snagless Channel-Rated Standard Patch Cord^	6210G-xx~
<b>[C]</b> eXtreme CAT 6A Snagless Channel-Rated Low-Smoke Zero-Halogen (LSZH) Patch Cord^	6AZ10-++°

xx = Length in feet

\* = Color: White (W), Yellow (Y), Red (R), Blue (L), Green (G), Grey (S), Black (E)

++ = Color: White (WH), Blue (BL), Grey (GY)

^ = Minimum orders and extended lead time may apply. Contact Inside Sales at 800.722.2082 for more details.

° = Length in meters

~ = Color: White (W), Red (R), Blue (L), Grey (S)

All Leviton CAT 6A/6 and 5e patch cords are RoHS Compliant.

### Make to order! CAT 6A PATCH CORD OPTIONS

CORD SERIES	CORD TYPE	BOOT TYPE	CABLE RATING	COLORS	STANDARD LENGTH (FEET)	MAKE-TO-ORDER LENGTH (FEET)
6AS10	CAT 6A FTP	SlimLine	CM (PVC)	White, Yellow, Red, Blue, Green, Grey, Black	3, 5, 7, 10, 15, 20	3-72
6210G	CAT 6A FTP	Snagless	CM (PVC)	White, Red, Blue, Grey	3, 5, 7, 10	N/A
6AZ10	CAT 6A FTP	Snagless	LSZH	White, Blue, Grey	1, 2, 3, 5 meters	N/A

All patch cords utilize stranded cable.

**For assistance customizing your patch cords, please visit [leviton.com/configurator](http://leviton.com/configurator) or call Tech Support at 800.824.3005.**

Note: Minimum order quantities may apply for Make-to-Order cords. Additional colors and lengths may be available as a special order.

Minimum orders and extended lead time may apply for special orders. Contact Inside Sales at 800.722.2082 for more information.

Colors:



++ LSZH Colors:

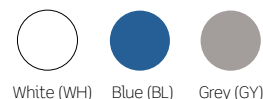

# PATCH CORDS & CABLE ASSEMBLIES | CAT 6 & 5e Patch Cords > UTP & Shielded

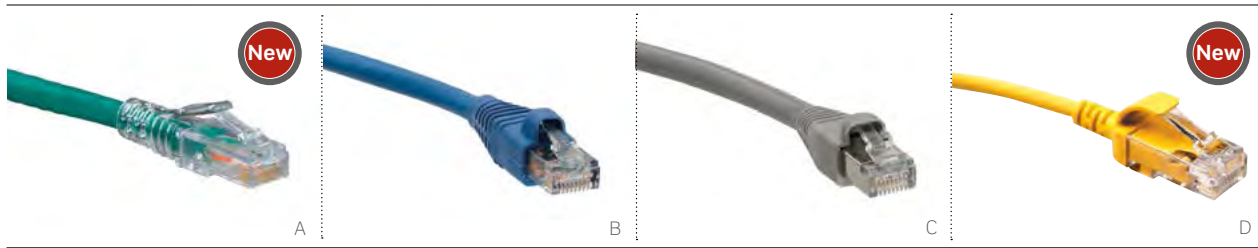

## CAT 6/5E UTP & SHIELDED PATCH CORDS

- SlimLine cords are independently tested and verified by Intertek (ETL) to meet ANSI/TIA-568-C.2 component requirements
- Standard and LSZH cords are independently tested and verified by Intertek (ETL) to meet ANSI/TIA-568-C.2 channel requirements
- SlimLine styles feature narrow-profile plug to reduce congestion in high-density applications
- SlimLine style strain-relief boot ensures long-term network performance
- SlimLine style snagless boot design prevents tab breakage
- 24-gauge stranded cable for maximum flexibility
- Standard shielded style for EMI/RFI protection

## HIGH-FLEX HD6 PATCH CORD 1G APPLICATION GRADE

- Ultra high-density design
- 28 AWG stranded for the ultimate flexibility
- Used in 1 Gigabit applications where CAT 6 patch cords are commonly utilized

### CAT 6/5E UTP PATCH CORDS

DESCRIPTION	CAT 6	CAT 5E
<b>[A]</b> Component-Rated SlimLine Patch Cord	6D460-xx*	5D460-xx◇
<b>[B]</b> Channel-Rated Standard Patch Cord, matching boot	62460-xx*	5G460-xx*
Snagless Low-Smoke Zero-Halogen (LSZH) Channel-Rated Patch Cord	6Z460-††°	—

### CAT 6/5E SHIELDED PATCH CORDS

<b>[C]</b> Snagless Channel-Rated Shielded Patch Cord, matching boot, grey only	6S460-xxS	5S460-xxS
---	-----------	-----------

### HIGH-FLEX HD6 CORDS

DESCRIPTION	1G
<b>[D]</b> High-Flex HD6 Patch Cord	6H460-xx•

\* = Color: White (W), Yellow (Y), Red (R), Blue (L), Green (G), Grey (S), Black (E)  
 xx = Length in feet  
 ◇ = Color: White (W), Red (R), Blue (L), Green (G), Grey (S)  
 †† = Color: White (WH), Blue (BL), Grey (GY)  
 ° = Length in meters  
 • = Color: White (W), Yellow (Y), Blue (L), Grey (S)  
 All Leviton CAT 6A/6 and 5e patch cords are RoHS Compliant.



## Make to order! CAT 6 & 5E PATCH CORD OPTIONS

CORD SERIES	CORD TYPE	BOOT TYPE	CABLE RATING	COLORS	STANDARD LENGTH (FEET)	MAKE-TO-ORDER LENGTH (FEET)
6D460	CAT 6 UTP	SlimLine	CM (PVC)	White, Yellow, Red, Blue, Green, Grey, Black	3, 5, 7, 10, 15, 20	1-200
62460	CAT 6 UTP	Snagless	CM (PVC)	White, Yellow, Red, Blue, Green, Grey, Black	3, 5, 7, 10, 15, 20	1-200
6Z460	CAT 6 UTP	Snagless	LSZH	White, Blue, Grey	1, 2, 3, 5 meters	N/A
6S460	CAT 6 FTP	Snagless	CM (PVC)	Grey	3, 5, 7, 10, 15, 20	1-200
6H460	1G UTP	Snagless	CM (PVC)	White, Yellow, Blue, Grey	0.5, 1, 2, 3, 4, 5, 7, 10, 15, 20	N/A
5D460	CAT 5e UTP	SlimLine	CM (PVC)	White, Yellow, Blue, Green, Grey	3, 5, 7, 10	1-200
5G460	CAT 5e UTP	Snagless	CM (PVC)	White, Yellow, Blue, Green, Grey	3, 5, 7, 10	1-200
5S460	CAT 5e FTP	Snagless	CM (PVC)	Grey	3, 5, 7, 10, 15, 20	1-200

All patch cords utilize stranded cable.

For assistance customizing your patch cords, please visit [leviton.com/configurator](http://leviton.com/configurator) or call Tech Support at 800.824.3005.

Note: Minimum order quantities may apply for Make-to-Order cords. Additional colors and lengths may be available as a special order. Minimum orders and extended lead time may apply for special orders. Contact Inside Sales at 800.722.2082 for more information.

Colors:



†† LSZH Colors:

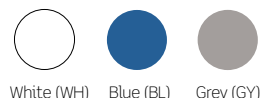

## BUILD YOUR OWN PRODUCTS WITH THE LEVITON MAKE-TO-ORDER PROGRAM

We've made building the exact solution for your network quicker and easier than ever. Rely on our innovative online custom configurators for a wide variety of copper products.



### CUSTOMIZE AND ORDER THROUGH LEVITON ONLINE CONFIGURATORS

- Pre-Terminated Copper Trunks - CAT 6A/6/5e
- Pre-Terminated Copper Trunks - e2XHD cassettes
- Secure RJ Patch Cords - CAT 6A/6

### SPECIAL ORDER

- Additional colors and lengths may be available as a special order
- Minimum orders and extended lead time apply for special orders
- Contact Tech Support at 800.824.3005 for more information

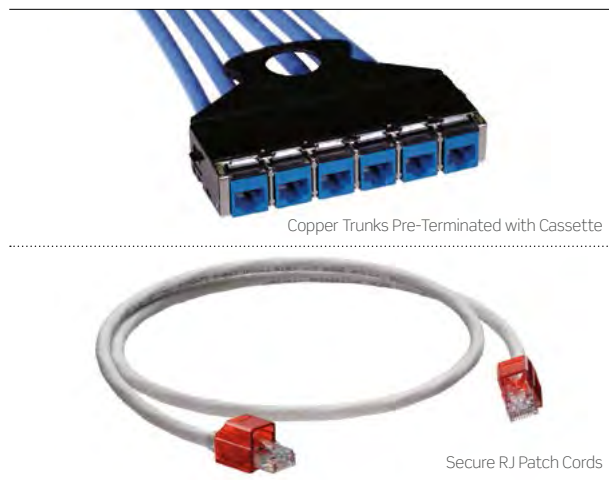

### COPPER TRUNK CABLE DIAGRAM (CUSTOMIZE AT LEVITON.COM/CONFIGURATOR)

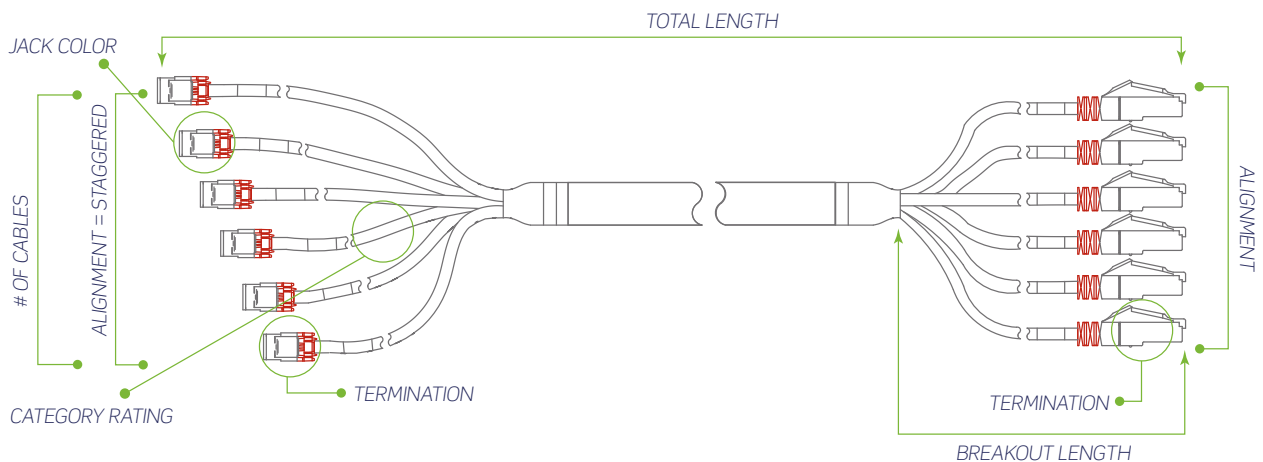

# PATCH CORDS & CABLE ASSEMBLIES | Pre-Terminated Trunks



UTP jack to plug



UTP jack to jack

## PRE-TERMINATED COPPER TRUNKS

- Custom configured for length, connector type, and more
- Fast and easy installation with reduced labor costs
- 100% factory tested, with test results available
- CAT 6A trunks all use component-rated connectors, which provide guaranteed performance in short lengths
- UTP connectors utilize patented Retention Force Technology (RFT) for consistent system reliability
- Plugs feature clear SlimLine design with snagless strain-relief boot
- Terminated ends offered in four staggered alignments or even cut
- Customized breakout length from braided sleeve improves installation flexibility and appearance
- Each assembly receives an individualized identification number, and individual cables are numbered relative to that identification number (custom labeling available on request)
- Optional pulling eye protects connectors and eases installation
- Pre-terminated assemblies are eligible for limited lifetime product, system, and performance warranties
- Noise-Canceling Helix Technology (NCHT) available to improve RF interference



### RECOMMENDED APPLICATIONS:

- Data Center Cabinets
- Telecommunications Racks
- Quick Network Deployment

Make to order!		PRE-TERMINATED COPPER TRUNK OPTIONS				
CABLE TYPE	CABLE RATING	# OF CABLES	CABLE LENGTH	CABLE COLOR*	INDIVIDUAL JACK COLOR	TERMINATION OPTIONS
CAT 6A UTP	CMP, CMR, LSZH	6, 8	10-295 feet 3-90 meters	Blue	White, Light Almond, Ivory, Yellow, Orange, Crimson, Red, Purple, Blue, Green, Grey, Black, Brown	Jack, Plug, Open
CAT 6A NCHT UTP	LSZH	6, 8	10-295 feet 3-90 meters	Blue	White, Light Almond, Ivory, Yellow, Orange, Crimson, Red, Purple, Blue, Green, Grey, Black, Brown	Jack, Plug, Open
CAT 6A FTP	CMP, CMR, LSZH	6, 8	10-295 feet 3-90 meters	Grey	Zinc	Jack, Open
CAT 6 UTP	CMP, CMR, LSZH	6, 8, 12	6-295 feet 2-90 meters	Blue	White, Light Almond, Ivory, Yellow, Orange, Crimson, Red, Purple, Blue, Green, Grey, Black, Brown	Jack, Plug, Open
CAT 6 FTP	CMP, CMR, LSZH	6, 8, 12	10-295 feet 3-90 meters	Grey	Zinc	Jack, Open
CAT 5e UTP	CMP, CMR	6, 8, 12	6-295 feet 2-90 meters	Blue	White, Light Almond, Ivory, Yellow, Orange, Crimson, Red, Purple, Blue, Green, Grey, Black, Brown	Jack, Plug, Open
CAT 5e FTP	CMP, CMR	6, 8, 12	10-295 feet 3-90 meters	Grey	Zinc	Jack, Open

\*Additional cable colors may be available, but would require extended lead time. Contact Inside Sales at 800.722.2082 for more details. All trunks utilize solid conductor cable.

For assistance customizing your copper trunks, please visit [leviton.com/configurator](http://leviton.com/configurator) or call Tech Support at 800.824.3005.



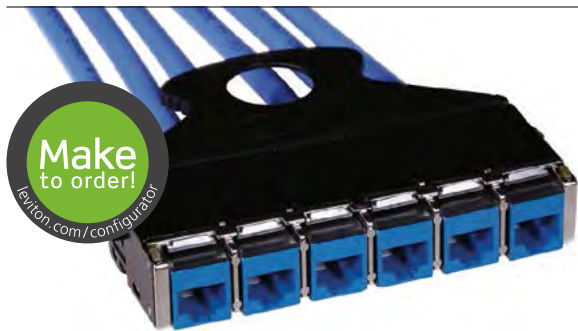

e2XHD copper cassettes are available either on pre-terminated trunks or kitted with field-terminated eXtreme® CAT 6A or CAT 6 connectors. See page A18 for field-terminated copper cassette kits.

Make to order!		e2XHD COPPER TRUNK ASSEMBLY OPTIONS					
CABLE TYPE	CABLE RATING	# OF CABLES	CABLE LENGTH	CABLE COLOR*	INDIVIDUAL JACK COLOR	CASSETTE JACK COLOR	TERMINATION OPTIONS
CAT 6A UTP	CMP, CMR, LSZH	6	10-295 feet 3-90 meters	Blue	White, Light Almond, Ivory, Yellow, Orange, Crimson, Red, Purple, Blue, Green, Grey, Black, Brown	Black, Blue, Green, Red, Yellow	Jack, Plug, Open, Cassette
CAT 6A NCHT UTP	LSZH	6	10-295 feet 3-90 meters	Blue	White, Light Almond, Ivory, Yellow, Orange, Crimson, Red, Purple, Blue, Green, Grey, Black, Brown	Black, Blue, Green, Red, Yellow, White	Jack, Plug, Open
CAT 6 UTP	CMP, CMR, LSZH	6	6-295 feet 2-90 meters	Blue	White, Light Almond, Ivory, Yellow, Orange, Crimson, Red, Purple, Blue, Green, Grey, Black, Brown	Black, Blue, Green, Red, Yellow, White	Jack, Plug, Open, Cassette

\*Additional cable colors may be available, but would require extended lead time. Contact Inside Sales at 800.722.2082 for more details. All trunks utilize solid conductor cable.

For assistance customizing your copper trunks, please visit [leviton.com/configurator](http://leviton.com/configurator) or call Tech Support at 800.824.3005.

### BREAKOUT & ALIGNMENT OPTIONS

Depending on the configuration chosen, different minimum breakout lengths apply. Choose from five different alignment options, or contact Tech Support at 800.824.3005 to discuss a custom alignment option. e2XHD Copper Trunks will always have an EVEN alignment on the cassette end(s).

	MINIMUM BREAKOUT LENGTHS	ALIGNMENT OPTIONS
Copper Trunks	<ul style="list-style-type: none"> <li>• 12 cables = 24" minimum</li> <li>• 8 cables = 20" minimum</li> <li>• 6 cables = 18" minimum</li> </ul>	<ul style="list-style-type: none"> <li>• Even</li> <li>• Stagger cable 1 shortest</li> <li>• Stagger cable 1 longest</li> <li>• Stagger cable 1 &amp; 2 shortest (plug)</li> <li>• Stagger cable 1 &amp; 2 longest (plug)</li> </ul>
e2XHD Copper Trunks	<ul style="list-style-type: none"> <li>• CAT 6 = 6" minimum</li> <li>• CAT 6A = 24" minimum</li> </ul>	<ul style="list-style-type: none"> <li>• Even</li> </ul>

## PATCH CORDS & CABLE ASSEMBLIES | Secure RJ System



The patented Secure RJ System provides physical security for critical network ports within data center, government, tech industry, health care, financial, retail, and education applications. Once connected, plugs can only be disengaged with the color-matched extraction tool. The secure system includes patch cords, port blockers, and extraction tools.

### SECURE RJ CABLE ASSEMBLY OPERATION

- Only extraction tools with the same keyed color as the Secure RJ connectors can remove patch cords
- Extraction tool features easy push-pull motion to remove connectors, even in high-density patch panels

### SECURE RJ SYSTEM

- Patented design prevents unauthorized and unintentional port access
- Superior locking mechanism requires matching-color extraction tool to release
- Compatible with industry-standard RJ ports in most network equipment, devices, patch panels, and work area outlets
- Works with high-density network equipment and 1RU 48-port patch panels
- Same-color extraction tool disengages color-matched patch cords and port blockers
- Transparent housing allows color coding without blocking visibility to Link/Status LEDs on electronic equipment
- Port blocker prevents unauthorized network connection and protects open, unused ports
- Available in eight transparent color options to reserve, identify, segregate, and secure network ports
- CAT 6A & CAT 6 Secure RJ Patch Cord options available



## Quality & Performance in Every Solution

**NEELAM SINGH**  
Senior Quality Engineer

Neelam performs product-quality audits and internal-process audits that adhere to the ISO 9001 Quality Management Systems standard. She evaluates and ensures quality not only during product development but throughout the supply chain, from the supplier to the end user. Neelam and the rest of the Leviton quality team play an essential role in ensuring your products deliver fast, reliable network performance.

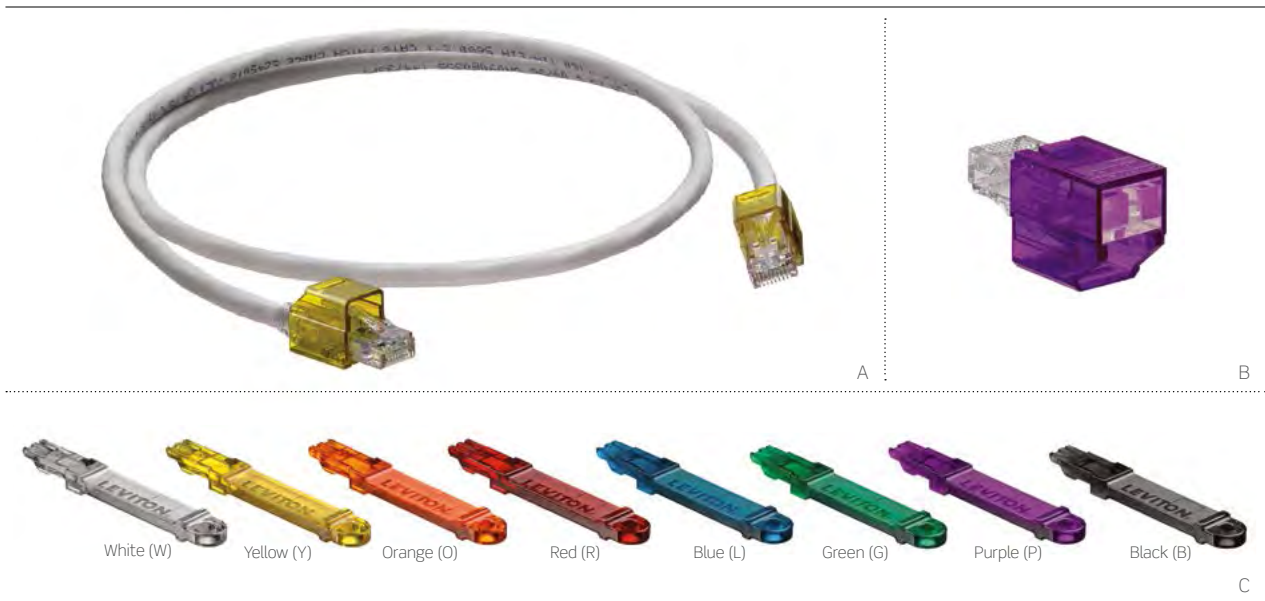

SECURE RJ SYSTEM	
DESCRIPTION	PART NO.
<b>[A]</b> CAT 6 SlimLine Patch Cord, with Secure RJ housing on both ends	SRJ6 <sup>+</sup> -xx*
<b>[B]</b> Secure RJ Port Blocker, pack of 12	SRJPB-00 <sup>†</sup>
<b>[C]</b> Secure RJ Extraction Tool, pack of 1	SRJET-00 <sup>‡</sup>

Patch cord jacket colors below:



xx = Length: (05), (10), or (20) feet. Minimum orders and extended lead time may apply. Contact inside Sales at 800.722.2082 for more details.  
<sup>†</sup> = Patch cord housing, port blocker, and extraction tool colors: Choose from the transparent colors shown in (C) above.  
<sup>\*</sup> = Patch cord jacket colors: Choose from the colors at right.

Make to order!		SECURE RJ PATCH CORD OPTIONS			
CATEGORY	CABLE RATING	CABLE COLOR	CABLE LENGTH	SECURE HOUSING COLOR	SECURE HOUSING PLACEMENT
CAT 6A FTP	CM (PVC)	White, Yellow, Red, Blue, Green, Grey, Black, Orange	3-72 feet	White, Yellow, Red, Blue, Green, Purple, Black, Orange	Both Ends One End
CAT 6 UTP	CM (PVC)	White, Yellow, Red, Blue, Green, Grey, Black	1-72 feet	White, Yellow, Red, Blue, Green, Purple, Black, Orange	Both Ends One End

All patch cords utilize stranded cable.

For assistance customizing your patch cords, please visit [leviton.com/configurator](http://leviton.com/configurator) or call Tech Support at 800.824.3005.



**SECURE RJ TRAINING VIDEO**  
 Watch the training video at [leviton.com/videos](http://leviton.com/videos):  
 "Secure RJ Copper Systems."

# COOPER



## category-rated connectors

### FEATURED PRODUCTS

CAT 6A Channel-Rated & Component-Rated Connectors **A37**

**New** CAT 6A Shielded Connectors **A40**

Ensure exceptional data connectivity performance with the patented QuickPort® line of category-rated connectors. Choose from channel-rated or best-in-class component-rated solutions at every performance level, from eXtreme® CAT 6A for 10G networks to legacy voice grade and USOC. For sensitive environments, shielded connectors in CAT 6A, 6, and 5e offer enhanced EMI/RFI protection and signal isolation.

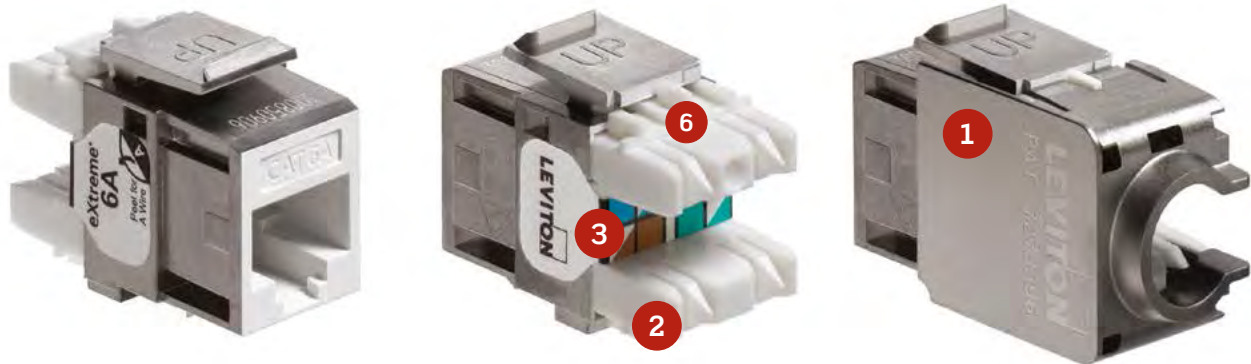

## 1 CONE OF SILENCE®

The patented Cone of Silence (CoS) is constructed with an advanced polymer material that surrounds the rear of the connector for superior alien crosstalk (AXT) suppression in CAT 6A connectors.

## 2 PAIR SEPARATION TOWERS

Included in all eXtreme® 6A, eXtreme 6+, and GigaMax® 5e+ connectors, the towers make termination quick and easy by physically separating each wire pair with a small, pointed tower.

## 3 DUAL-LAYER, TEAR-AWAY CONNECTOR LABELS

Patented connector wiring-scheme labels make field termination faster and easier. Our patented tear-away, dual-wiring labels feature easy-to-read, double-layer diagrams. The top layer shows the T568B configuration for commercial installations. Peel back the easy-lift label to access the residential T568A schematic.

## 4 RETENTION FORCE TECHNOLOGY (RFT)

Patented Retention Force Technology, found in all CAT 6A, 6+, and 5e+ connectors, as well as in CAT 6 and 5e 110-style panels, provides unequalled durability and reliability for demanding applications. Its key feature, the polymer spring, supports tines and increases their resilience.

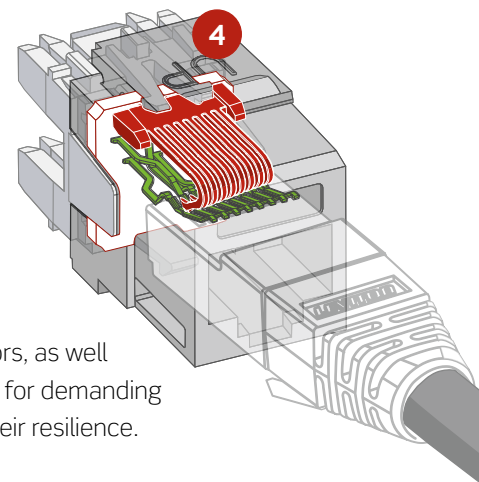

## 5 QUICKPORT

Interchangeable QuickPort components allow you to create the perfect mix of voice, data, video, and audio for any application. The QuickPort family of connectors and inserts are compatible in any QuickPort housing, including over 180 patch panels and wallplates. Available in 13 TIA 606-B compatible colors.

## 6 CUTTING LEDGE

Designed to work flawlessly with the 110 punchdown tool. Eliminates the risk of double punching that causes contractors to lose time on a job.



# CATEGORY-RATED CONNECTORS | CAT 6A UTP QuickPort®

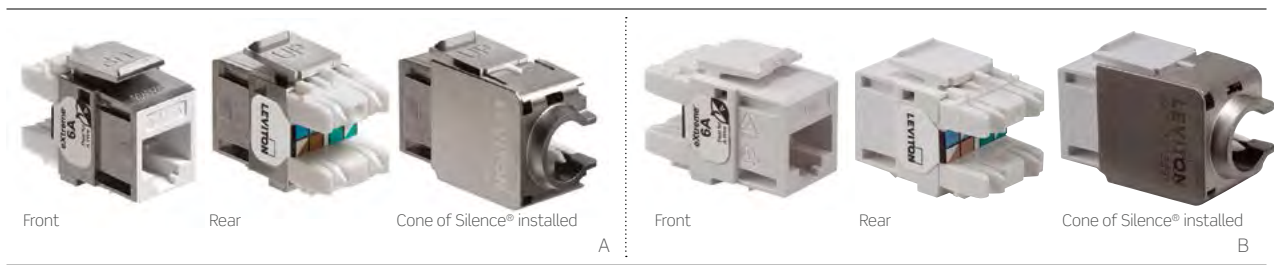

## QUICKPORT CAT 6A UTP CONNECTORS

eXtreme® CAT 6A component-rated UTP connectors include several exclusive performance-enhancing features:

- Component-rated connector features a metalized body, triple-stage compensation, and other design features that suppress alien crosstalk (AXT)
- Conductor retention feature holds wires during termination
- Ideal for data centers where short link performance is critical

All eXtreme CAT 6A connectors include a wealth of features that deliver ease-of-use and superior performance:

- Independently verified and guaranteed by Intertek (ETL) to exceed ANSI/TIA-568-C.2 component, permanent link, and channel margins, and IEEE 10GBASE-T (802.3an) requirements, as well as the ISO/IEC 11801 2nd Edition, CAT 6A Component, and Class E<sub>A</sub> standard
- Patented Cone of Silence helps suppress AXT
- Patented Retention Force Technology (RFT) protects against damage from 4- or 6-pin plugs
- Pair Separation Towers facilitate quick, effective termination
- Patented dual-layer T568A and T568B label with larger wiring diagrams
- Backward compatible with CAT 6 and 5e systems, and 1000BASE-T applications
- Provide seamless migration path to 10GBASE-T to maximize return on investment

### CAT 6A UTP QUICKPORT CONNECTORS

DESCRIPTION	PART NO.
[A] eXtreme CAT 6A UTP Component-Rated QuickPort Connector	6A10G-R*6
[B] eXtreme CAT 6A UTP Channel-Rated QuickPort Connector	6110G-R*6

See "CAT 6A Termination Instructions" on page X7.

\* = Colors: Choose from any of the colors below.  
All Leviton Category-Rated and USOC Connectors are RoHS Compliant.



## SPOTLIGHT Component- vs. Channel-Rated Performance

FEATURE	COMPONENT RATED	CHANNEL RATED
Meets ANSI/TIA standard	x	x
Exceeds ANSI/TIA standard	x	
Complete end-to-end channel tested	x	x
Individually certified (tested) component	x	
Meets channel-link performance	x	x
Greater permanent-link performance	x	
Ensures multi-manufacturer channel compatibility	x	



# CATEGORY-RATED CONNECTORS | CAT 6/5e+/5e UTP QuickPort®



## EXTREME® CAT 6+ UTP COMPONENT-RATED QUICKPORT CONNECTORS

eXtreme CAT 6+ UTP component-rated QuickPort connectors include several features that deliver ease-of-use and superior performance:

- Patented Retention Force Technology (RFT) protects tines from damage from 4- or 6-pin plugs
- Pair Separation Towers facilitate quick, effective termination
- Patented dual-layer wiring label simplifies punchdown and reduces rework
- Increased wire retention reduces tine contact failure caused by cable stress and fatigue
- Gas-tight connection at the IDC prevents corrosion
- 110-style rear termination field for easy termination when installed in a wallplate or panel

### JACKRAPID™ TOOL



Free with purchase of 150 QuickPort connectors  
6 bags of 25, Part Numbers:  
61110-J^6, 5G110-J^5, 5G108-J^5

## CAT 5E UTP QUICKPORT CONNECTORS

Leviton offers two CAT 5e connectors, the GigaMax® CAT 5e+ (5G110-xxx) and 5e (5G108-xxx). Both provide 1000BASE-T performance for high-bandwidth applications.

### GigaMax CAT 5e+ (5G110) connectors include exclusive performance-enhancing features:

- Component-rated for optimal channel performance
- Patented Retention Force Technology (RFT) protects against damage from 4- or 6-pin plugs
- Pair Separation Towers facilitate quick, effective termination
- Patented dual-layer wiring label simplifies punchdown and reduces rework

See "CAT 6 & 5e Termination Instructions" on pages X7 and X8.

## CAT 6+/5E+/5E UTP QUICKPORT CONNECTORS

DESCRIPTION	PART NO.	QUICKPACK® 25/BAG	QUICKPACK 6 BAGS OF 25 WITH JACKRAPID TOOL (150)
<b>[A]</b> eXtreme CAT 6+ UTP Component-Rated Connector	61110-R*6	61110-B*6	61110-J^6
<b>[B]</b> GigaMax CAT 5e+ UTP Component-Rated Connector	5G110-R*5	5G110-B*5	5G110-J^5
<b>[C]</b> GigaMax CAT 5e UTP Channel-Rated Connector	5G108-R*5	5G108-B*5	5G108-J^5

\* = Colors: Choose from any of the colors below    ^ = Colors: White (W), Ivory (I), Orange (O), Blue (L), and Black (E)    ° = Colors: White (W) and Blue (L)  
All Leviton Category-Rated and USOC Connectors are RoHS Compliant.



## SPOTLIGHT

### QuickPack



Save time and reduce packaging waste on large installations with QuickPack, the original bulk quantity connector package. With the resealable and easy-to-store bag, unused product can be saved until needed. Each QuickPack bag contains 25 connectors and a minimum of 27 stuffer caps. QuickPack is available in eXtreme 6+, GigaMax 5e+ and 5e, and all 13 connector colors. See table above for part numbers.

# CATEGORY-RATED CONNECTORS | CAT 5/3/USOC QuickPort®



## CAT 5/3 & USOC UTP QUICKPORT CONNECTORS

- Fit into all QuickPort wallplates and housings
- Full support of voice and low-speed data applications
- CAT 5/3 and 8P8C USOC accept RJ-45 plugs; 6P6C USOC accepts RJ-11 plugs

## CONNECTOR ADAPTER BEZELS

Leviton Connector Adapter Bezels allow all QuickPort connectors to be installed into compatible, third-party wallplates and surface-mount boxes (SMBs).

- Bezel color will be visible after installation
- Packaged individually and sold separately from connectors
- CommScope® bezels fit SYSTIMAX® or Uniprise® wallplates and SMBs

CAT 5/3/USOC UTP QUICKPORT CONNECTORS	
DESCRIPTION	PART NO.
<b>[A]</b> CAT 5 Connector	41108-R*5
<b>[B]</b> CAT 3 Connector	41108-R*3
USOC Connector, 8P8C	41108-R*8
<b>[C]</b> USOC Connector, 6P6C	41106-R*6
CONNECTOR ADAPTER BEZELS	
<b>[D]</b> LexCom Connector Adapter Bezel (connector not included)	AB300-00 <sup>†</sup>
<b>[E]</b> CommScope Connector Adapter Bezel (connector not included)	AB100-00 <sup>†</sup>
<b>[F]</b> Clipsal® Connector Adapter Bezel (connector not included)	AB200-00*

<sup>†</sup> = Colors: Choose from white or black.

\* = Colors: Choose from any of the colors below.

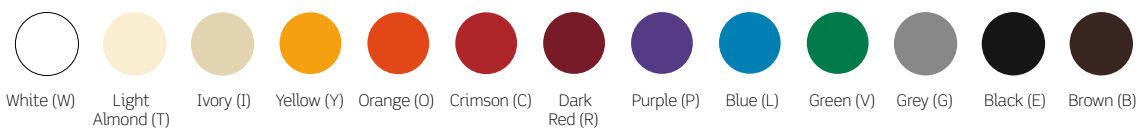





**CAT 6A/6/5E COMPONENT-RATED SHIELDED QUICKPORT CONNECTORS**

- Independently verified and guaranteed by Intertek (ETL) to exceed ANSI/TIA-568-C.2 component, permanent link, and channel margins, and IEEE 10GBASE-T (802.3an) requirements, as well as the ISO/IEC 11801 2nd Edition, CAT 6A Component, and Class E<sub>A</sub> standard
- Shielding provides electromagnetic interference (EMI) and radio frequency interference (RFI) protection, signal isolation, and excellent alien crosstalk (AXT) suppression
- Small form factor supports industry-standard density and is compatible with the QuickPort footprint
- Robust die-cast housing
- 270° wide-angle hinge provides easy access and termination
- Tool free, no punchdown tool required; snaps closed when termination is complete
- Compatible with F/UTP, U/FTP, and other common shielded cable types

**CAT 6A/6/5E COMPONENT-RATED SHIELDED QUICKPORT CONNECTORS**

DESCRIPTION	PART NO.
<b>[A]</b> eXtreme® CAT 6A Component-Rated Shielded QuickPort Connector	6ASHD-S6A
<b>[B]</b> eXtreme CAT 6 Component-Rated Shielded QuickPort Connector	6S180-SH6
<b>[C]</b> GigaMax® CAT 5e Component-Rated Shielded QuickPort Connector	5S180-SH5

Use housings designed for shielded connectors. All Leviton Category-Rated and USOC Connectors are RoHS Compliant. See pages A50 and A54 for wallplates and surface-mount boxes, and pages A15-A16 for patch panels.

See "Shielded Connector Termination Instructions" on page X8. Or watch the training video online at [leviton.com/videos](http://leviton.com/videos): "How to Terminate a Leviton Shielded Connector."



**SPOTLIGHT** Shielded Patch Panels

Leviton shielded patch panels are available in 1RU 24-port and 2RU 48-port flat and angled options, and accept all CAT 6A, 6, and 5e QuickPort shielded connectors. They use a stainless-steel "comb" to maintain consistent ground paths between connectors and the panel, and offer superior protection from electromagnetic interference (EMI) and radio frequency interference (RFI).





## FEATURED PRODUCTS

Multimedia Outlet System (MOS) Modules **A45**

## A/V connectivity

Deliver the high-quality signals that are required for today's technologies with the Leviton line of A/V (audio/video) connectivity solutions. Connectors and adapters come in dozens of styles from QuickPort® HDMI®, S-video, and BNC to RCA, F-type, and many more. For larger multimedia applications, choose the Multimedia Outlet System (MOS) and configure wallplates with your choice of snap-in copper, fiber, audio, and video modules.

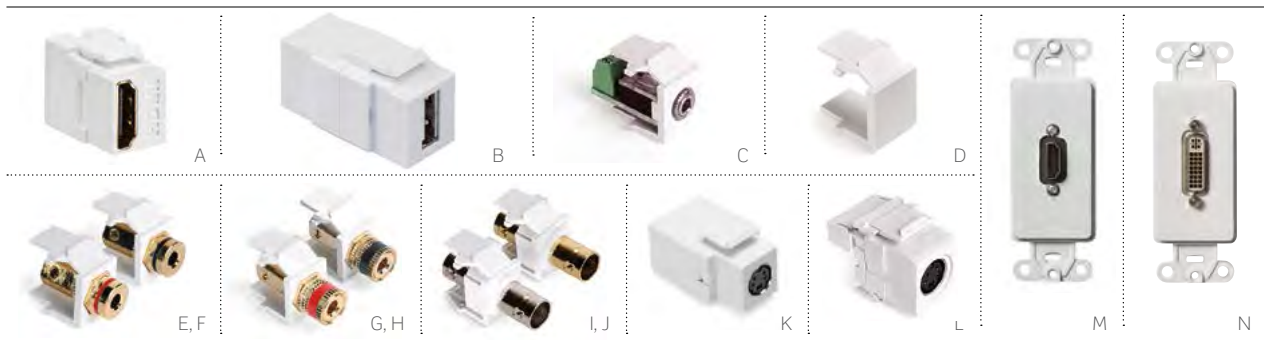

## A/V CONNECTORS & ADAPTERS

- HDMI® connector works with HDMI Type A connectors
- Binding Post and Banana Jack connectors are excellent for advanced audio
- QuickPort Blanks secure unused ports in wallplates and housings for future expansion
- 3.5 mm Stereo Adapter facilitates classroom, workstation, and computer audio applications
- Use BNC connectors for commercial CCTV or commercial video signals
- S-video for enhanced video streams available in feedthrough and 110 termination
- Decora® wallplate inserts with HDMI and DVI connections provide high-definition video with in-wall wiring

### QUICKPORT A/V CONNECTORS & ADAPTERS

DESCRIPTION	WHITE	LT. ALMOND	IVORY	GREY	BLACK	BROWN
<b>[A]</b> HDMI Connector, feedthrough	40834-00W	40834-00T	40834-00I	—	40834-00E	—
<b>[B]</b> USB A/A Connector, feedthrough	40835-00W	—	40835-00I	40835-00G	—	—
<b>[C]</b> 3.5 mm Stereo Adapter, screw terminal	40839-SWS	—	40839-SIS	—	—	—
<b>[D]</b> Blank Insert (pack of 10)	41084-BWB	41084-BTB	41084-BIB	41084-BGB	41084-BEB	41084-BBB
<b>[E]</b> Banana Jack Connector, red stripe, feedthrough	40837-BWR	40837-BTR	40837-BIR	—	—	—
<b>[F]</b> Banana Jack Connector, black stripe, feedthrough	40837-BWE	40837-BTE	40837-BIE	—	—	—
<b>[G]</b> Binding Post Connector, red stripe, feedthrough	40833-BWR	40833-BTR	40833-BIR	—	40833-BER	40833-BBR
<b>[H]</b> Binding Post Connector, black stripe, feedthrough	40833-BWE	40833-BTE	40833-BIE	—	40833-BEE	40833-BBE
<b>[I]</b> BNC Connector, nickel plated, feedthrough	41084-BWF	41084-BTF	41084-BIF	41084-BGF	41084-BEF	41084-BBF
<b>[J]</b> BNC Connector, gold plated, feedthrough	40832-0BW	40832-0BT	40832-0BI	—	—	—
<b>[K]</b> S-Video Connector, feedthrough	40734-CVW	—	40734-CVI	—	—	—
<b>[L]</b> S-Video Adapter, 110 termination	40734-SVW	40734-SVT	40734-SVI	40734-SVG	40734-SVE	—

### QUICKPORT A/V INSERTS, DECORA

<b>[M]</b> HDMI Insert, feedthrough	41647-00W	—	41647-00I	—	—	—
<b>[N]</b> DVI Insert, feedthrough	41648-00W	—	41648-00I	—	—	—



## A/V CONNECTIVITY | QuickPort® A/V Connectors > RCA & F-Style

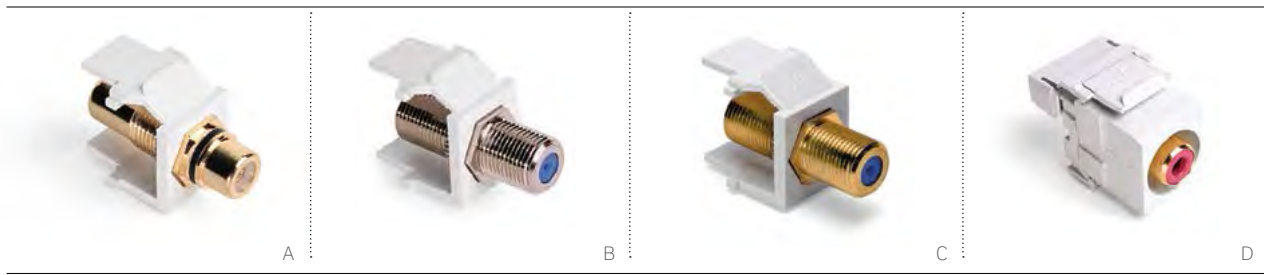

### FEEDTHROUGH & 110-STYLE RCA & F-CONNECTORS

Leviton carries a comprehensive selection of RCA and F-connectors in both feedthrough and 110 termination. Body colors match Leviton housings; barrel colors are industry standard.

#### RCA CONNECTORS

- Standard identification colors for component and composite video
- Ideal for advanced audio

#### F-CONNECTORS

- Coax connectors ideal for satellite and cable TV
- Nickel- and gold-plated versions are both SCTE-compliant and support signals up to 3 GHz

#### QUICKPORT FEEDTHROUGH RCA & F-CONNECTORS (FOR RCA & COAX CABLE)

DESCRIPTION	WHITE	LT. ALMOND	IVORY	GREY	BLACK	BROWN
<b>[A]</b> RCA Connector, gold plated w/black stripe, feedthrough	40830-BWE	40830-BTE	40830-BIE	40830-BGE	40830-BEE	40830-BBE
RCA Connector, gold plated w/red stripe, feedthrough	40830-BWR	40830-BTR	40830-BIR	40830-BGR	40830-BER	40830-BBR
RCA Connector, gold plated w/yellow stripe, feedthrough	40830-BWY	40830-BTY	40830-BIY	—	—	—
RCA Connector, gold plated w/green stripe, feedthrough	40830-BWV	—	40830-BIV	—	—	—
RCA Connector, gold plated w/blue stripe, feedthrough	40830-BWL	—	40830-BIL	—	—	—
<b>[B]</b> F-Connector, nickel plated, feedthrough	41084-FWF	41084-FTF	41084-FIF	41084-FGF	41084-FEF	41084-FBF
<b>[C]</b> F-Connector, gold plated, feedthrough	40831-0BW	40831-0BT	40831-0BI	—	—	—

#### QUICKPORT 110-STYLE RCA CONNECTORS (FOR CAT 6 OR CAT 5E CABLE)

<b>[D]</b> RCA Connector, gold plated w/red barrel, 110 termination	40735-RRW	40735-RRT	40735-RRI	40735-RRG	40735-RRE	—
RCA Connector, gold plated w/white barrel, 110 termination	40735-RWW	40735-RWT	40735-RWI	40735-RWG	40735-RWE	—
RCA Connector, gold plated w/yellow barrel, 110 termination	40735-RYW	40735-RYT	40735-RYI	40735-RYG	40735-RYE	—
RCA Connector, gold plated w/green barrel, 110 termination	40735-RVW	—	40735-RVI	—	—	—
RCA Connector, gold plated w/blue barrel, 110 termination	40735-RLW	—	40735-RLI	—	—	—
RCA Connector, gold plated w/orange barrel, 110 termination	40735-ROW	40735-ROT	40735-ROI	40735-ROG	40735-ROE	—

See color swatches on page A42.



**COMPRESSION, CRIMP-ON & TWIST-ON RCA & F-CONNECTORS**

Leviton compression, crimp-on, and twist-on connectors are ideal for more specialized A/V applications. Compression connectors, available stand-alone or with QuickPort® housings, offer an airtight seal and secure fitting for increased cable retention. Crimp-on and twist-on connectors are an economical solution for less demanding applications.

**RCA CONNECTORS**

- RCA compression connectors include six color rings for signal identification
- RCA compression connectors offer high-quality installations using RG-6 quad shield cable

**F-CONNECTORS**

- Compression F-connectors offer high-quality installations using quad shield cable
- RG-6 connectors available in one- and two-piece twist-on and crimp-on styles

COMPRESSION, CRIMP-ON & TWIST-ON RCA & F CONNECTORS			
DESCRIPTION	RG-59 CABLE	RG-6 CABLE	RG-6 QUAD SHIELD
RCA Compression Connector (colored rings included)	—	—	<b>[A]</b> 40985-CRU
Compression F-Connector (colored rings included)	—	—	<b>[B]</b> 40985-CPF
F-Connectors, one-piece crimp-on (bag of 100)	<b>[C]</b> 40985-1P9	<b>[D]</b> 40985-1P6	<b>[E]</b> 40985-0Q6
F-Connectors, two-piece crimp-on (bag of 100)	<b>[F]</b> 40985-2P9	<b>[G]</b> 40985-2P6	—
F-Connectors, twist-on (bag of 100)	<b>[H]</b> 40985-TW9	<b>[I]</b> 40985-TW6	—

See page A67 for master compression and crimping tools.

**SPOTLIGHT** QuickPort Inserts For Decora® Wallplates



Install QuickPort category-rated and A/V connectors in any Decora or Decora Plus wallplate using QuickPort Decora Inserts. Choose from one-port to six-port inserts and six different colors. For options, see page A51.

## A/V CONNECTIVITY | Multimedia Outlet System

The innovative Multimedia Outlet System (MOS) consists of a surface-mount box and single- and dual-gang wallplates that accept a variety of copper, fiber, and A/V connectors. The system is ideal for multimedia applications in conference rooms, training rooms, classrooms, auditoriums, and other areas.



### MULTIMEDIA OUTLET SYSTEM (MOS)

- Front-load installation ensures simple moves, adds, and changes
- Modules are available in 0.5, 1, 1.5, 2, and 3 unit-high sizes
- Surface-mount housings accept 1 unit-high module only
- Plates accept 3 units high total
- Accommodates a combination of QuickPort® connectors and larger A/V components such as 3-port composite/component RCA and HD-15 connectors
- Allows for flexibility in applications where deployment of a variety of voice, data, audio, and visual systems is needed

For fiber optic MOS products see pages B65-B66.

### INSTALLATION VIDEOS



Watch the training videos at [leviton.com/videos](http://leviton.com/videos): "Enhanced MOS RCA Module Installation" and "Enhanced MOS VGA Module Installation."

### SAMPLE CONFIGURATIONS FOR MOS WALLPLATES

Single-Gang Wallplate

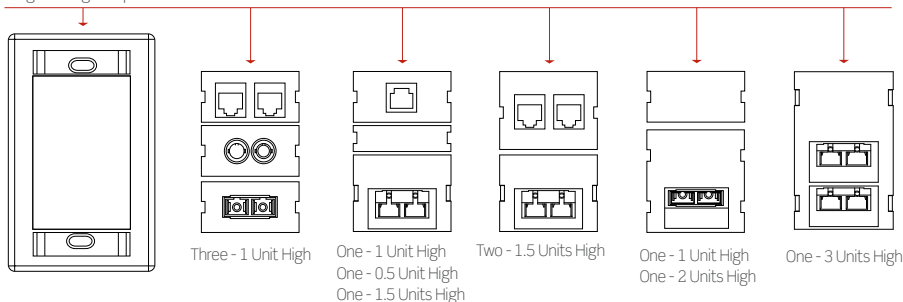

### SPOTLIGHT QuickPort & MOS Compatibility

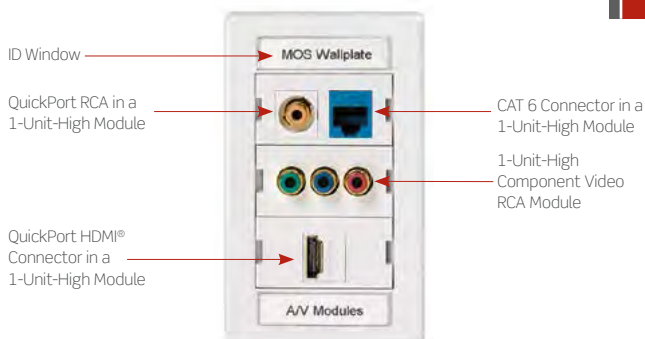

The MOS system allows you to customize wallplates with any combination of voice, data, audio, and video connectivity. A/V connector module options include VGA, RCA component, and RCA composite video, while QuickPort adapter modules expand your options to include QuickPort category-rated connectors, HDMI, DVI, USB, S-video, F-connectors, and more. Blank inserts are also available to create a finished look when building in extra capacity for future growth.

# A/V CONNECTIVITY | Multimedia Outlet System

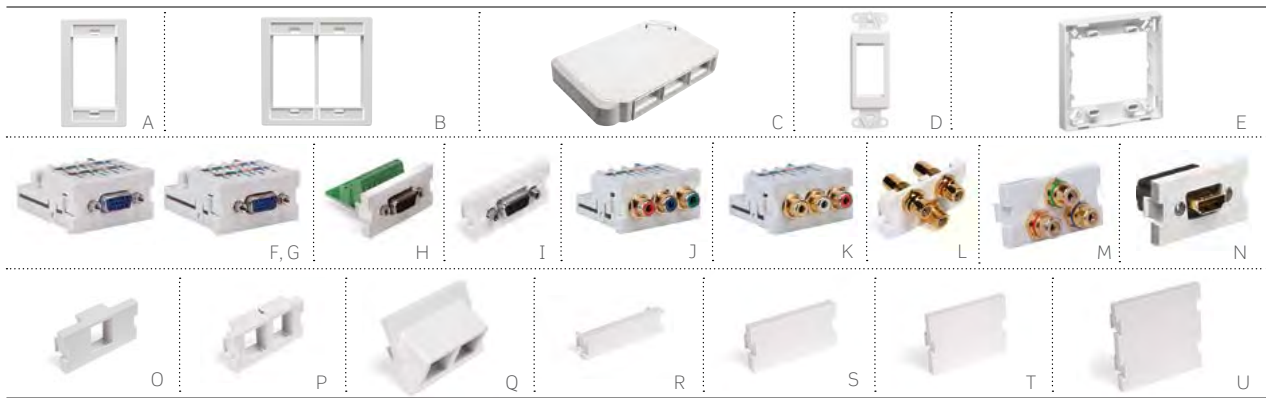

## MULTIMEDIA OUTLET SYSTEM HOUSINGS

DESCRIPTION	WHITE	LT. ALMOND	IVORY	GREY	BLACK
<b>[A]</b> Single-Gang Wallplate	41290-SMW	41290-SMT	41290-SMI	41290-SMG	41290-SME
<b>[B]</b> Dual-Gang Wallplate	41290-DMW	41290-DMT	41290-DMI	41290-DMG	41290-DME
<b>[C]</b> Surface-Mount Box*	41296-MMW	41296-MMT	41296-MMI	41296-MMG	41296-MME
<b>[D]</b> Decora® Insert, holds one 1-unit-high MOS Module	41649-00W	—	41649-00I	—	—
<b>[E]</b> Fiber Storage/Spacer Ring	41290-DRW	—	41290-DRI	41290-DRG	41290-DRE

## MULTIMEDIA OUTLET SYSTEM A/V CONNECTOR MODULES (ALL MODULES ARE 1 UNIT HIGH)

<b>[F]</b> VGA PC Module, 110-style termination^	41295-VPW	41295-VPT	41295-VPI	41295-VPG	—
<b>[G]</b> VGA Monitor Module, 110-style termination^	41295-VMW	41295-VMT	41295-VMI	41295-VMG	—
<b>[H]</b> VGA/HD15 Module, screw terminal	41295-HDW	—	41295-HDI	—	—
<b>[I]</b> VGA/HD15 Module, feedthrough	41293-HDW	41293-HDT	41293-HDI	41293-HDG	41293-HDE
VGA/HD15 Module, empty	41291-DBW	41291-DBT	41291-DBI	41291-DBG	41291-DBE
<b>[J]</b> RCA Component Video Module, 110-style termination (red, green, blue)	41292-DEW	41292-DET	41292-DEI	—	—
<b>[K]</b> RCA Composite Video Module, 110-style termination (red, white, yellow)	41292-AEW	41292-AET	41292-AEI	—	—
<b>[L]</b> 3-Port RCA Module (red, black, yellow), feedthrough	41292-3RW	41292-3RT	41292-3RI	41292-3RG	41292-3RE
<b>[M]</b> 3-Port RCA Module (red, green, blue), feedthrough	41292-3DW	41292-3DT	41292-3DI	41292-3DG	41292-3DE
<b>[N]</b> HDMI® Module, feedthrough	41290-HDW	41290-HDT	41290-HDI	41290-HDG	41290-HDE

## MULTIMEDIA OUTLET SYSTEM QUICKPORT® ADAPTERS & BLANK MODULES

<b>[O]</b> 1-Port QuickPort Module (1 unit high)	41291-1MW	41291-1MT	41291-1MI	41291-1MG	41291-1ME
<b>[P]</b> 2-Port QuickPort Module (1 unit high)	41291-2QW	41291-2QT	41291-2QI	41291-2QG	41291-2QE
<b>[Q]</b> 2-Port Angled QuickPort Module (1.5 units high)	41294-2QW	41294-2QT	41294-2QI	41294-2QG	41294-2QE
<b>[R]</b> Blank Module (0.5 unit high)	41295-5BW	41295-5BT	41295-5BI	41295-5BG	41295-5BE
<b>[S]</b> Blank Module (1 unit high)	41291-1BW	41291-1BT	41291-1BI	41291-1BG	41291-1BE
<b>[T]</b> Blank Module (1.5 units high)	41294-2BW	41294-2BT	41294-2BI	41294-2BG	41294-2BE
<b>[U]</b> Blank Module (2 units high)	41292-2BW	41292-2BT	41292-2BI	41292-2BG	41292-2BE

\* = Surface-mount box is not compatible with 41295-V\*\*, 41292-D\*\*, and 41292-A\*\*.

^ = 110-Style VGA modules require both PC and Monitor modules used in pairs to operate. This applies to F and G only.

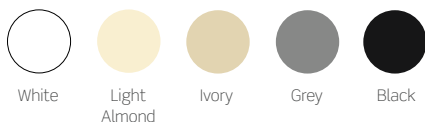

Leviton MOS with 110-style termination offers fast, easy punch-down using CAT 5e or higher UTP or shielded cable. This allows use of remnant cable and provides a simple migration path to digital without changes to in-wall cables.





## wallplates & housings

Customize your work-area outlets with an extensive selection of wallplates and housings. We have the colors and styles you need for virtually any type of application. The Renu® system offers tool-free, snap-on wallplate installation and QuickPort® compatibility. Additional wallplates come in plastic and stainless; 1 to 12 ports in single- or dual-gang; wall, surface, or furniture mount; IP67 rated for industrial environments; even pre-configured for telephone and video.

A majority of our datacom wallplates are now designed and manufactured in the United States.

### FEATURED PRODUCTS

Renu wallplates & inserts **A52**





## QUICKPORT STANDARD PLASTIC WALLPLATES

- Compatible with all QuickPort connectors and adapters
- Manufactured from ABS plastic for superior resistance to impact, chemicals, and solvents, as compared to other plastics
- A variety of color choices, with color-matched screws
- cULus Listed, fire-retardant material rated UL 94V-0

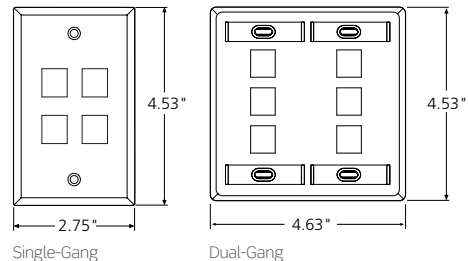

Single-Gang      Dual-Gang  
Find wallplate Labeling Solutions on page A68.

### [A] QUICKPORT SINGLE-GANG WALLPLATES

DESCRIPTION	WHITE	LT. ALMOND	IVORY	GREY	BLACK	BROWN
6-Port Wallplate	41080-6WP	41080-6TP	41080-6IP	41080-6GP	41080-6EP	41080-6BP
4-Port Wallplate	41080-4WP	41080-4TP	41080-4IP	41080-4GP	41080-4EP	41080-4BP
3-Port Wallplate	41080-3WP	41080-3TP	41080-3IP	41080-3GP	41080-3EP	41080-3BP
2-Port Wallplate	41080-2WP	41080-2TP	41080-2IP	41080-2GP	41080-2EP	41080-2BP
1-Port Wallplate	41080-1WP	41080-1TP	41080-1IP	41080-1GP	41080-1EP	41080-1BP

### [B] QUICKPORT SINGLE-GANG WALLPLATES WITH ID WINDOWS

6-Port Wallplate	42080-6WS	42080-6TS	42080-6IS	42080-6GS	42080-6ES	—
4-Port Wallplate	42080-4WS	42080-4TS	42080-4IS	42080-4GS	42080-4ES	—
3-Port Wallplate	42080-3WS	42080-3TS	42080-3IS	42080-3GS	42080-3ES	—
2-Port Wallplate	42080-2WS	42080-2TS	42080-2IS	42080-2GS	42080-2ES	—
1-Port Wallplate*	42080-1WS	42080-1TS	42080-1IS	42080-1GS	42080-1ES	—

### [C] QUICKPORT DUAL-GANG WALLPLATES WITH ID WINDOWS

12-Port Wallplate	42080-12W	42080-12T	42080-12I	42080-12G	42080-12E	—
8-Port Wallplate	42080-8WP	42080-8TP	42080-8IP	42080-8GP	42080-8EP	—
6-Port Wallplate	42080-6WP	42080-6TP	42080-6IP	42080-6GP	42080-6EP	—
4-Port Wallplate	42080-4WP	42080-4TP	42080-4IP	42080-4GP	42080-4EP	—
3-Port Wallplate	42080-3WP	42080-3TP	42080-3IP	42080-3GP	42080-3EP	—
2-Port Wallplate†	42080-2WP	42080-2TP	42080-2IP	42080-2GP	42080-2EP	—
1-Port Wallplate†	42080-1WP	42080-1TP	42080-1IP	42080-1GP	42080-1EP	—

Wallplates are sold empty. See pages A37-A43 for QuickPort connectors.

\*Single-gang 1-Port Wallplate has only one ID window on top.

†Dual-gang 1- and 2-Port Wallplates have only two ID windows on top.



# WALLPLATES & HOUSINGS | QuickPort® Wallplates > Stainless Steel



## QUICKPORT STAINLESS-STEEL WALLPLATES

- Compatible with all QuickPort adapters and connectors, including shielded
- Manufactured from 304 stainless steel in a brushed finish to provide corrosion resistance in a non-magnetic material
- Available in single- and dual-gang, with or without ID windows
- Angled wallplate ports facilitate proper front and rear cable bend radius
- Wall-phone wallplates are available in flush and recessed options to accommodate various phone styles
- cULus Listed

### QUICKPORT SINGLE-GANG STAINLESS-STEEL WALLPLATES

DESCRIPTION	[A]	STANDARD	[B]	W/ ID WINDOW
6-Port Wallplate		43080-1S6		43080-1L6
4-Port Wallplate		43080-1S4		43080-1L4
3-Port Wallplate		43080-1S3		43080-1L3
2-Port Wallplate		43080-1S2		43080-1L2
1-Port Wallplate		43080-1S1		43080-1L1

### QUICKPORT DUAL-GANG STAINLESS-STEEL WALLPLATES

12-Port Wallplate	43080-S12	43080-L12
8-Port Wallplate	43080-2S8	43080-2L8
6-Port Wallplate	43080-2S6	43080-2L6
4-Port Wallplate	43080-2S4	43080-2L4
2-Port Wallplate	43080-2S2	43080-2L2

### [C] QUICKPORT ANGLED STAINLESS-STEEL WALLPLATES W/ ID WINDOWS

DESCRIPTION	PART NO.
4-Port Angled Wallplate, single-gang	43081-1L4
8-Port Angled Wallplate, dual-gang	43081-2L8

### [D] QUICKPORT STAINLESS-STEEL WALL-PHONE WALLPLATES

Stainless-Steel Wall-Phone Wallplate	4108W-0SP
Stainless-Steel Wall-Phone Wallplate, recessed	4108W-1SP

Wallplates are sold empty. See pages A37-A43 for QuickPort connectors.  
See page A62 for voice-grade wall-phone jacks.  
See page X15 for more information on stainless-steel materials.

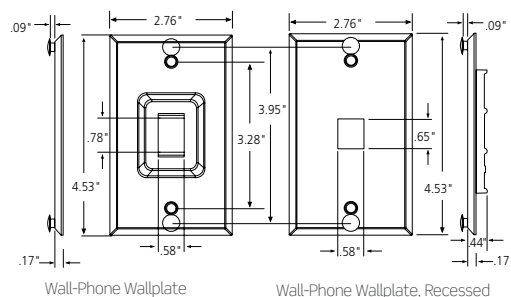
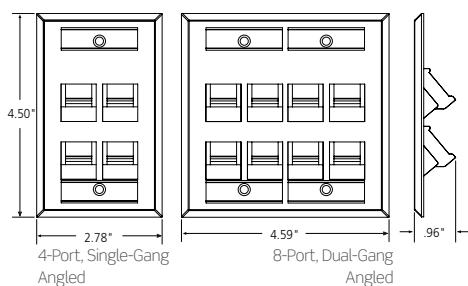
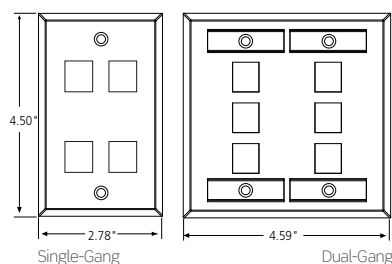

### LABELS

DESCRIPTION	PART NO.
Label Kit for QuickPort Stainless-Steel Wallplates*	43080-IDW
Pre-printed Port Labels, black ink, 10 sheets per package	41080-LEB

\* = Also applicable to ID window wallplates on page A50.

# WALLPLATES & HOUSINGS | QuickPort® Wallplates > Special Configurations



## QUICKPORT ANGLED, MIDWAY & LARGE CONNECTOR WALLPLATES

- Compatible with all QuickPort connectors and adapters
- Angled and large connector wallplates are high-quality ABS plastic, which provides superior resistance to impacts, chemicals, and solvents as compared to other plastics
- Midway wallplates are durable nylon with a smooth finish and help to hide irregular drywall cuts or flaws around outlets
- Large connector wallplates are ideal for use with larger-sized shielded connectors
- Angled wallplates facilitate optimal cable management and ensure proper bend radius in front and back of connector
- cULus Listed, fire-retardant material rated UL 94V-0

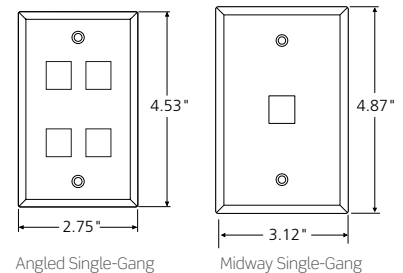

Angled Single-Gang and Single-Gang for Large Connectors

Midway Single-Gang

Find wallplate Labeling Solutions on page A68.

### [A] QUICKPORT ANGLED SINGLE-GANG WALLPLATES

DESCRIPTION	WHITE	LT. ALMOND	IVORY	BROWN
4-Port Wallplate	41081-4WP	41081-4TP	41081-4IP	—
2-Port Wallplate	41081-2WP	41081-2TP	41081-2IP	—
4-Port Wallplate, w/ ID windows	42081-4WS	42081-4TS	42081-4IS	—
2-Port Wallplate, w/ ID windows	42081-2WS	42081-2TS	42081-2IS	—

### [B] QUICKPORT MIDWAY SINGLE-GANG WALLPLATES

6-Port Wallplate	41091-6WN	41091-6TN	41091-6IN	41091-6BN
4-Port Wallplate	41091-4WN	41091-4TN	41091-4IN	41091-4BN
3-Port Wallplate	41091-3WN	41091-3TN	41091-3IN	41091-3BN
2-Port Wallplate	41091-2WN	41091-2TN	41091-2IN	41091-2BN
1-Port Wallplate	41091-1WN	41091-1TN	41091-1IN	41091-1BN

### [C] QUICKPORT SINGLE-GANG WALLPLATES FOR LARGE CONNECTORS

4-Port Wallplate	41080-4WL	41080-4TL	41080-4IL	—
2-Port Wallplate	41080-2WL	41080-2TL	41080-2IL	—
4-Port Wallplate, w/ ID windows	42080-4WL	42080-4TL	42080-4IL	—
2-Port Wallplate, w/ ID windows	42080-2WL	42080-2TL	42080-2IL	—



# WALLPLATES & HOUSINGS | QuickPort® Decora® Inserts & Floor Box Assemblies

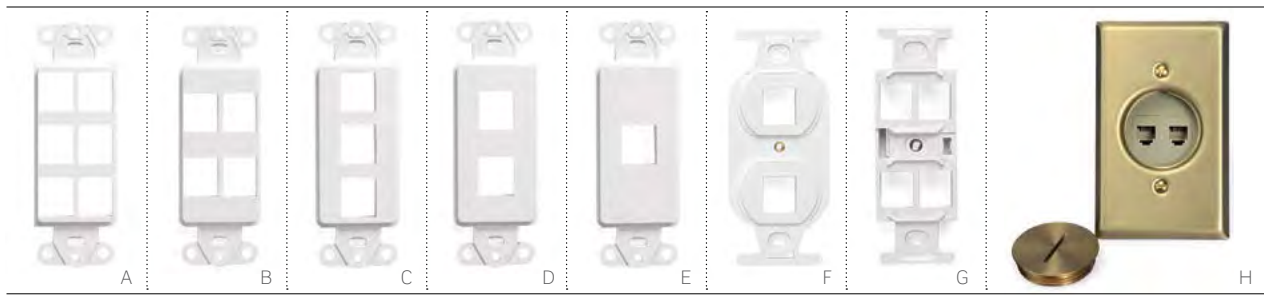

## QUICKPORT DECORA & DUPLEX INSERTS

- Combine voice, data, and A/V connectors in popular Decora and Duplex wallplate formats
- Decora inserts are compatible with Decora and Decora Plus wallplates

## QUICKPORT FLOOR BOX ASSEMBLIES

- Combine voice, data, and A/V connectors in convenient in-floor locations
- Floor box assemblies include brass wallplate and screw cap
- Inserts and connectors are ivory



Inserts fit Decora and 106-style Duplex wallplates found on pages A63-A64.

Find wallplate Labeling Solutions on page A68.

### QUICKPORT DECORA MULTIMEDIA INSERTS

DESCRIPTION	WHITE	LT. ALMOND	IVORY	GREY	BLACK	BROWN
<b>[A]</b> 6-Port Insert	41646-00W	41646-00T	41646-00I	41646-0GY	41646-00E	41646-00B
<b>[B]</b> 4-Port Insert	41644-00W	41644-00T	41644-00I	41644-0GY	41644-00E	41644-00B
<b>[C]</b> 3-Port Insert	41643-00W	41643-00T	41643-00I	41643-0GY	41643-00E	41643-00B
<b>[D]</b> 2-Port Insert	41642-00W	41642-00T	41642-00I	41642-0GY	41642-00E	41642-00B
<b>[E]</b> 1-Port Insert	41641-00W	41641-00T	41641-00I	41641-0GY	41641-00E	41641-00B
Blank Insert	80414-00W	80414-00T	80414-00I	80414-0GY	80414-00E	80414-00B

### QUICKPORT DECORA TYPE 106 DUPLEX INSERTS

<b>[F]</b> 2-Port Duplex Insert	41087-2WP	41087-2TP	41087-2IP	41087-2GP	41087-2EP	—
<b>[G]</b> 4-Port Duplex Insert	41087-QWP	41087-QTP	41087-QIP	41087-QGP	41087-QEP	—

### QUICKPORT FLOOR BOX ASSEMBLY W/ INSERT, BRASS PLATE & SCREW CAP

DESCRIPTION	PART NO.
Floor Box Assembly, one F-connector module, one blank module	41650-00F
Floor Box Assembly, one 6P6C connector, one blank module	41650-006
Floor Box Assembly, two port, includes one blank module	41652-000
<b>[H]</b> Floor Box Assembly, two 6P6C connectors	41652-006
Floor Box Assembly, one 6P6C connector, one F-connector module	41652-06F

Inserts A-G are sold empty. See pages A37-A43 for QuickPort connectors.  
Floor Box Assemblies sold as complete kits only, individual components not sold separately.





Renu is the smart electrical and data connectivity system. QuickPort® compatible wallplates snap on and off quickly and easily with no tools, simplifying installation and ongoing maintenance. Choose from wallplates and inserts in White On White, Navajo Sand, Onyx Black, and Stainless Appearance.

**RENU WALLPLATES AND INSERTS**

- Screwless wallplates easily snap on to any Renu insert or device
- Inserts accept all QuickPort connectors
- Slightly larger size covers wall imperfections
- Tongue and groove design simplifies alignment in multi-gang installations
- Adapter ring allows use of Decora® device with Renu wallplates
- Available in four standard colors to coordinate with the commercial-grade QuickPort line (white, light almond, black, stainless)
- Additional wallplate colors for switches, dimmers, and outlets available; visit [leviton.com/renu](http://leviton.com/renu)
- cULus Listed
- 1 year limited warranty

RENU WALLPLATES & INSERTS				
DESCRIPTION	WHITE ON WHITE	NAVAJO SAND	ONYX BLACK	STAINLESS APPEARANCE
<b>[A]</b> Snap-In Blank Module	RE640-BWW	RE640-BNS	RE640-BOB	—
Four-Gang Wallplate	REWP4-0WW	REWP4-0NS	REWP4-0OB	—
<b>[B]</b> Three-Gang Wallplate	REWP3-0WW	REWP3-0NS	REWP3-0OB	—
<b>[C]</b> Dual-Gang Wallplate	REWP2-0WW	REWP2-0NS	REWP2-0OB	REWM2-ST5
<b>[D]</b> Single-Gang Wallplate	REWP1-0WW	REWP1-0NS	REWP1-0OB	REWM1-ST5
<b>[E]</b> 6-Port Insert	RE640-WW6	RE640-NS6	RE640-OB6	—
<b>[F]</b> 4-Port Insert	RE640-WW4	RE640-NS4	RE640-OB4	—
<b>[G]</b> 3-Port Insert	RE640-WW3	RE640-NS3	RE640-OB3	—
<b>[H]</b> 2-Port Insert	RE640-WW2	RE640-NS2	RE640-OB2	—
<b>[I]</b> 1-Port Insert	RE640-WW1	RE640-NS1	RE640-OB1	—



Find wallplate Labeling Solutions on page A68.

# WALLPLATES & HOUSINGS | QuickPort® Boxes, Modules & Accessories



QuickPort Surface-Mount Boxes are easily field configured with QuickPort connectors (sold separately) and contain knockouts to accommodate raceway and cable entry. They can be mounted with screws or adhesive mounting tape (both provided), or with magnets or modular furniture brackets (sold separately).

QuickPort Modular Furniture Products offer simple snap-in installation and an attractive streamlined appearance. Furniture faceplates accept QuickPort connectors and snap easily and snugly into standard modular furniture. Modular Furniture Brackets facilitate installation of Leviton surface-mount boxes or faceplates with back boxes.

## QUICKPORT BOXES, MODULES & ACCESSORIES

- Surface-mount boxes and back boxes have breakouts to match common surface-mount raceway systems
- 4S089 products are designed to work with Leviton shielded or eXtreme® CAT 6A connectors to allow proper bend radius control

## QUICKPORT MODULAR FURNITURE PRODUCTS

- Front-load installation of module ensures simple moves, adds, and changes without removing the furniture channel cover
- Faceplates are cULus Listed

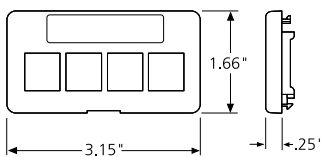

**2- & 4-Port Standard Depth Modular Faceplate**  
Fits openings of approximately 1.38" x 2.63" (1 3/8" x 2 5/8")

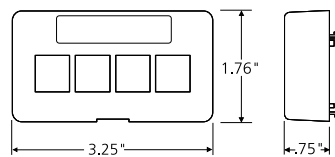

**4-Port Extended Depth Modular Faceplate for installation into shallow raceway channels**  
Fits openings of approximately 1.38" x 2.63" (1 3/8" x 2 5/8")

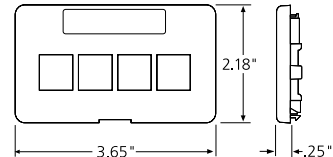

**Herman Miller 2- & 4-Port Modular Faceplate**  
Fits openings of approximately 1.88" x 2.98" (1 7/8" x 2 7/8")

Standard- and extended-depth faceplates are compatible when used with Herman Miller G1189A Reducer, available from Herman Miller dealers.

## QUICKPORT SURFACE-MOUNT BOXES

DESCRIPTION	WHITE	IVORY	GREY	BLACK
<b>[A]</b> 12-Port Surface-Mount Box, 7.60" W x 5.02" D x 1.13" H	41089-12W	41089-12I	41089-12G	41089-12E
<b>[B]</b> 6-Port Surface-Mount Box, 6.38" W x 3.22" D x 1.08" H	41089-6WP	41089-6IP	41089-6GP	41089-6EP
<b>[C]</b> 4-Port Surface-Mount Box, 4.77" W x 3.21" D x 1.05" H	41089-4WP	41089-4IP	41089-4GP	41089-4EP
<b>[D]</b> 2-Port Surface-Mount Box, 2.52" W x 2.22" D x 1.10" H	41089-2WP	41089-2IP	41089-2GP	41089-2EP
<b>[E]</b> 1-Port Surface-Mount Box, 1.42" W x 2.22" D x 1.10" H	41089-1WP	41089-1IP	41089-1GP	41089-1EP
<b>[F]</b> 2-Port Surface-Mount Box for Shielded Connectors*, 2.5" W x 3.00" D x 1.22" H	4S089-2WP	4S089-2IP	—	—
<b>[G]</b> 4-Port Surface-Mount Box for Shielded Connectors*, 5.6" W x 5.20" D x 1.22" H	4S089-4WP	4S089-4IP	—	—

## SINGLE- AND DUAL-GANG SURFACE-MOUNT BACK BOXES

<b>[H]</b> Single-Gang Standard Back Box, 4.72" H x 2.96" W x 1.89" D	42777-1WA	42777-1IA	42777-1GA	42777-1EA
<b>[I]</b> Single-Gang Shallow Back Box, 4.72" H x 2.96" W x 1.45" D	42777-1WB	42777-1IB	42777-1GB	42777-1EB
<b>[J]</b> Dual-Gang Standard Back Box, 4.72" H x 4.77" W x 1.89" D	42777-2WA	42777-2IA	42777-2GA	42777-2EA
<b>[K]</b> Dual-Gang Shallow Back Box, 4.72" H x 4.77" W x 1.45" D	42777-2WB	42777-2IB	42777-2GB	42777-2EB

## MAGNETS AND MODULAR FURNITURE BRACKETS

**DESCRIPTION** (Use one magnet for 2-port surface-mount housing. Use two magnets for 4-, 6-, and 12-port surface-mount housings and single- and dual-gang surface-mount back boxes.)

	PART NO.
<b>[L]</b> Set of 4 Magnets, 1.00" H x 0.84" W x 0.30" D	41030-SMJ

## MODULAR FURNITURE BRACKETS

DESCRIPTION	PART NO.
<b>[M]</b> Steelcase 9000®, Haworth®, Knoll®, Allsteel®, Westinghouse®, and Teknion®	49222-BLK
<b>[N]</b> Herman Miller Ethospace® and Steelcase Avenir®	49222-ESP
<b>[O]</b> Herman Miller Action Office®	49222-HAO

## QUICKPORT MODULAR FURNITURE FACEPLATES

DESCRIPTION	WHITE	IVORY	GREY	BLACK
2-Port Standard Depth	49910-SW2	49910-SI2	49910-SG2	49910-SE2
<b>[P]</b> 4-Port Standard Depth w/ 1 QuickPort Blank	49910-SW4	49910-SI4	49910-SG4	49910-SE4
4-Port Extended Depth w/ 1 QuickPort Blank	49910-EW4	49910-EI4	49910-EG4	49910-EE4
2-Port Herman Miller	49910-HW2	49910-HI2	49910-HG2	49910-HE2
<b>[Q]</b> 4-Port Herman Miller w/ 1 QuickPort Blank	49910-HW4	49910-HI4	49910-HG4	49910-HE4

\*For shielded connectors and large bend radius cables.



White



Ivory



Grey



Black

## WALLPLATES & HOUSINGS | DuraPort® Industrial Connectivity



### DURAPORT CONNECTOR HOUSING

- Twist-lock mating allows for easy installation and provides a robust seal
- Compatible with eXtreme® 6+ and GigaMax® 5e+ QuickPort® connectors
- Captive connector cap with retainer protects and seals unused ports

### DURAPORT STAINLESS-STEEL WALLPLATE

- Patented overmolded gasket on wallplates provides a watertight fit
- Compatible with standard NEMA boxes

### DURAPORT OUTLET KIT

- DuraPort components packaged together for added convenience
- Kits include connector housing, connector cap, and stainless-steel wallplate
- Patch cords and QuickPort connectors are sold separately

### DURAPORT PATCH CORDS

- Available in industrial plug to industrial plug, and industrial plug to RJ-45 plug configurations
- Patch cords are CAT 6 rated

### SPOTLIGHT

### Industrial Wallplate Design



The **DuraPort industrial wallplate** is manufactured with a patented, industry-first, overmolded gasket that provides a watertight fit. The gasket seals not only the edge of the plate where it meets the wall, but also extends behind each mounting screw hole for a complete seal without the need for conventional O-rings. In addition to providing exceptional sealing, the integrated wallplate and gasket also help to position and retain screws during installation, so the wallplate aligns perfectly and seats flush every time. All this translates into IP67-class protection that safeguards your network in severe conditions and resists moisture, dust, corrosion, acids, oils, and vibration.



## DURAPORT INDUSTRIAL CONNECTOR HOUSINGS

DESCRIPTION	PART NO.
<b>[A]</b> CAT 6 Industrial Connector Housing w/ Connector Cap (product supplied w/ black 61110 connector)	D6706-00E
CAT 5e Industrial Connector Housing w/ Connector Cap (product supplied w/ black 5G110 connector)	D675E-00E
Housing w/ Connector Cap (connector not included)	D6700-00E
Connector Cap (connector and housing not included)	D6701-00E

## DURAPORT INDUSTRIAL STAINLESS-STEEL WALLPLATES

<b>[B]</b> Industrial Wallplate, stainless steel, 1-port, single-gang	D6710-1S1
<b>[C]</b> Industrial Wallplate, stainless steel, 2-port, single-gang	D6710-1S2
<b>[D]</b> Industrial Wallplate, stainless steel, 2-port, dual-gang	D6710-2S2
<b>[E]</b> Industrial Wallplate, stainless steel, 4-port, dual-gang	D6710-2S4

## DURAPORT INDUSTRIAL PATCH CORDS, CAT 6

<b>[F]</b> Industrial Plug to Industrial Plug, 3'	D6720-03E
Industrial Plug to Industrial Plug, 5'	D6720-05E
Industrial Plug to Industrial Plug, 7'	D6720-07E
Industrial Plug to Industrial Plug, 10'	D6720-10E
Industrial Plug to Industrial Plug, 15'	D6720-15E
Industrial Plug to Industrial Plug, 20'	D6720-20E
<b>[G]</b> Industrial Plug to RJ-45 Plug, 3'	D6721-03E
Industrial Plug to RJ-45 Plug, 5'	D6721-05E
Industrial Plug to RJ-45 Plug, 7'	D6721-07E
Industrial Plug to RJ-45 Plug, 10'	D6721-10E
Industrial Plug to RJ-45 Plug, 15'	D6721-15E
Industrial Plug to RJ-45 Plug, 20'	D6721-20E

## DURAPORT INDUSTRIAL OUTLET KITS

Industrial Outlet Kit, stainless steel, 1-port, single-gang	D670K-1S1
<b>[H]</b> Industrial Outlet Kit, stainless steel, 2-port, single-gang	D670K-1S2
Industrial Outlet Kit, stainless steel, 2-port, dual-gang	D670K-2S2
<b>[I]</b> Industrial Outlet Kit, stainless steel, 4-port, dual-gang	D670K-2S4

### IP67-RATED INGRESS PROTECTION

IP ratings are based on International Standard IEC 60529. All DuraPort products are IP67 rated as highlighted in the charts.

See page X15 for more information on NEMA and IEC enclosure certification.

#### PROTECTION AGAINST SOLID OBJECTS

<b>0</b> None
<b>1</b> Solid objects larger than 50 mm
<b>2</b> Solid objects larger than 12.5 mm
<b>3</b> Solid objects larger than 2.5 mm
<b>4</b> Solid objects larger than 1.0 mm
<b>5</b> Dust
<b>6</b> Dust tight

#### PROTECTION AGAINST WATER

<b>0</b> None
<b>1</b> Vertically falling water drops
<b>2</b> Vertically falling water drops (up to 15° angle)
<b>3</b> Spraying water
<b>4</b> Splashing water
<b>5</b> Water jets
<b>6</b> Powerful water jets
<b>7</b> Temporary immersion in water
<b>8</b> Continuous immersion in water

## WALLPLATES & HOUSINGS | 86 mm x 86 mm Excella® British Standard



### EXCELLA WALLPLATE INSERTS & FRAMES

- Inserts available in 1-, 2-, and 4-port flat, and 1- and 2-port angled configurations
- All 1- and 2-port inserts include designation windows
- Inserts accept QuickPort® connectors (sold separately)
- 86 mm x 86 mm frame size conforms to BS 4662 and BS 5733 electrical box standards
- Inserts are white and ship with white wallplate frame
- Colored frames available separately (see colors and part numbers below)

#### EXCELLA WALLPLATE INSERTS

DESCRIPTION	PART NO.
<b>[A]</b> QuickPort Wallplate Insert w/ ID Window, 1-port, empty	BL186-P1W
QuickPort Wallplate Insert w/ ID Window, 2-port, empty	BL186-P2W
QuickPort Wallplate Insert, 4-port, empty	BL186-P4W
<b>[B]</b> QuickPort Angled Wallplate Insert w/ ID Window, 1-port, empty	BL186-A1W
QuickPort Angled Wallplate Insert w/ ID Window, 2-port, empty	BL186-A2W
Blank Wallplate Insert	BL000-00W

#### EXCELLA METALLIC WALLPLATE FRAMES

Wallplate Frame, pearl yellow	BLWP1-PEY
Wallplate Frame, piano black	BLWP1-PIB
Wallplate Frame, glossy silver	BLWP1-GSS
Wallplate Frame, champagne gold	BLWP1-CHG
Wallplate Frame, navy blue	BLWP1-NVB
Wallplate Frame, metallic green	BLWP1-MEG
Wallplate Frame, hot pink	BLWP1-HTP
Wallplate Frame, sky blue	BLWP1-SKB

Wallplates sold empty. See pages A37-A43 for QuickPort connectors.

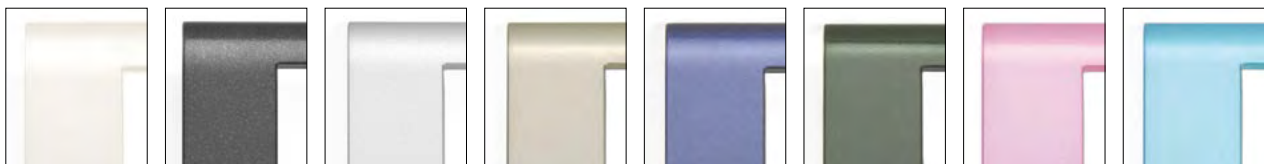

Pearl Yellow

Piano Black

Glossy Silver

Champagne Gold

Navy Blue

Metallic Green

Hot Pink

Sky Blue

# WALLPLATES & HOUSINGS | 86 mm x 86 mm French, British & LJ6C Style



## FRENCH-, BRITISH- & LJ6C-STYLE WALLPLATE INSERTS

- Designed to fit matching 86 mm x 86 mm wallplates
- Accept QuickPort® data connectors (sold separately)
- Include ID window kits for port designation
- Spring-loaded shutters protect connector while not in use
- Available in white ABS plastic

## DIMENSIONS

- French-style inserts fit 45 mm x 45 mm openings
- British-style inserts fit 50 mm x 50 mm openings
- LJ6C-style inserts fit 22 mm x 37 mm openings

### [A] FRENCH-STYLE WALLPLATE INSERTS

DESCRIPTION	PART NO.
French-style Wallplate Insert, 45 mm x 22.5 mm, 1-port, flat, white	LI145-1W1
French-style Wallplate Insert, 45 mm x 45 mm, 1-port, flat, white	LI145-2W1
French-style Wallplate Insert, 45 mm x 45 mm, 2-port, flat, white	LI145-2W2
French-style Wallplate Frame (for use with French-style LI145 inserts only), single-gang, white (special order)	LF145-01W

### [B] BRITISH-STYLE WALLPLATE INSERTS

British-style Wallplate Insert, 50 mm x 25 mm, 1-port, flat, white	LI150-1W1
British-style Wallplate Insert, 50 mm x 25 mm, 1-port, angled, white	LI150-AW1
British-style Wallplate Insert, 50 mm x 50 mm, 1-port, flat, white	LI150-2W1
British-style Wallplate Insert, 50 mm x 12.5 mm, blank, flat, white	LI150-0W0

### [C] LJ6C-STYLE WALLPLATE INSERTS

LJ6C-style Wallplate Insert, 37 mm x 22 mm, 1-port, flat, white	LI137-1W1
LJ6C-style Wallplate Insert, 37 mm x 22 mm, 1-port, angled, white	LI137-AW1

Note: French-style, British-style, and LJ6C-style inserts are not compatible with Excella® wallplates.

# WALLPLATES & HOUSINGS | Telephone & Video Wallplates

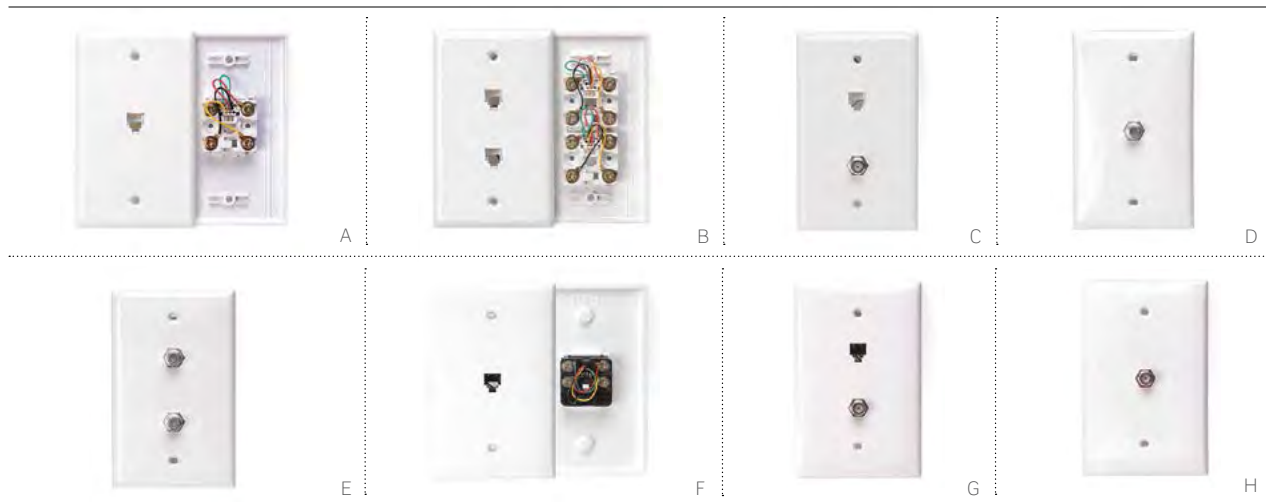

## TELEPHONE & VIDEO WALLPLATES

- Provide quick at-the-wall connections for RJ-11 telephone and F-connection video applications
- High-quality ABS plastic or nylon, which provides superior resistance to impacts, chemicals, and solvents as compared to other plastics
- Midway wallplates hide irregular drywall cuts or flaws around outlets
- cULus Listed, fire-retardant material rated UL 94V-0

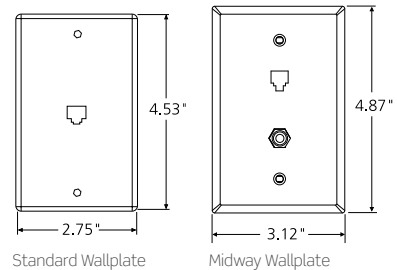

### STANDARD TELEPHONE & VIDEO WALLPLATES

DESCRIPTION	WHITE	LT. ALMOND	IVORY	BROWN
<b>[A]</b> Wall Jack, 6P4C	40249-00W	40249-00T	40249-00I	—
<b>[B]</b> Wall Jack, 6P4C + 6P4C	40244-00W	40244-00T	40244-00I	—
<b>[C]</b> Wall Jack, 6P4C + F-connector	40259-00W	40259-00T	40259-00I	—
<b>[D]</b> Wall Jack, F-connector	80781-00W	80781-00T	80781-00I	—
<b>[E]</b> Wall Jack, F-connector + F-connector	80782-00W	80782-00T	80782-00I	—
Wall Jack, 6P6C	40238-00W	—	—	—
Wall Jack, 6P6C + F-connector	40258-00W	—	—	—

### MIDWAY TELEPHONE & VIDEO WALLPLATES (NYLON)

<b>[F]</b> Wall Jack, 6P4C	40539-PMW	40539-PMT	40539-PMI	40539-PMB
<b>[G]</b> Wall Jack, 6P4C + F-connector	40539-CMW	40539-CMT	40539-CMI	40539-CMB
<b>[H]</b> Wall Jack, F-connector	40539-0MW	40539-0MT	40539-0MI	40539-0MB



## DECORA TELEPHONE & VIDEO WALLPLATES

- 6P4C models feature lead-frame design for improved reliability and simple installation
- Decora inserts are compatible with Decora wallplates and Decora Plus screwless wallplates
- Decora wallplate assemblies include a Decora insert and matching Decora wallplate
- Decora Kits include a 1- or 2-port QuickPort® Decora insert and snap-in USOC or F-type QuickPort connectors
- Inserts, assemblies, and kits are cULus Listed and rated UL 94V-0



Inserts fit Decora Wallplates found on page A63.

### DECORA STANDARD TELEPHONE & VIDEO WALLPLATE ASSEMBLIES (WALLPLATE INCLUDED)

DESCRIPTION	WHITE	LT. ALMOND	IVORY	GREY	BLACK	BROWN
<b>[A]</b> Wall Jack, 6P4C	40149-00W	40149-00T	40149-00I	—	—	—
<b>[B]</b> Wall Jack, 6P4C + 6P4C	40144-00W	40144-00T	40144-00I	—	—	—
<b>[C]</b> Wall Jack, 6P4C + F-connector	40159-00W	40159-00T	40159-00I	—	—	—
<b>[D]</b> Wall Jack, F-connector	40981-0WD	40981-0TD	40981-0ID	—	—	—
<b>[E]</b> Wall Jack, F-connector + F-connector	40982-0WD	40982-0TD	—	—	—	—

### DECORA TELEPHONE & VIDEO INSERTS (WALLPLATE NOT INCLUDED)

<b>[F]</b> Wall Jack, 6P4C	40649-00W	40649-00T	40649-00I	40649-0GY	40649-00E	40649-000
<b>[G]</b> Wall Jack, 6P4C + 6P4C	40644-00W	40644-00T	40644-00I	—	—	—
<b>[H]</b> Wall Jack, 6P4C + F-connector	40659-00W	40659-00T	40659-00I	—	40659-00E	—
<b>[I]</b> Wall Jack, F-connector	40681-00W	40681-00T	40681-00I	40681-0GY	—	40681-00B
<b>[J]</b> Wall Jack, F-connector + F-connector	40682-00W	—	40682-00I	—	—	—

### DECORA TELEPHONE & VIDEO INSERT KITS (WALLPLATE NOT INCLUDED)

Wall Jack, 6P6C (QuickPort insert with snap-in jack)	41638-00W	41638-00T	41638-00I	—	—	—
Wall Jack, 6P6C + F-connector (QuickPort insert with snap-in jack and snap-in F-connector )	41658-00W	—	41658-00I	—	—	—



# WALLPLATES & HOUSINGS | Round Telephone Inserts & Surface-Mount Boxes



A



B



C

## ROUND TELEPHONE INSERTS & SURFACE-MOUNT BOXES

- Round inserts available with screw terminal or 110 terminations
- See page A64 for wallplates with round openings
- Surface-mount boxes feature 4-, 6-, and 8-conductor screw terminal connections
- Shorting bar option for use with monitored home security systems

4625A-xxx, 40278-00x

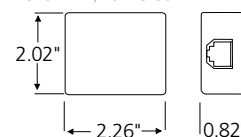

40278-5Bx

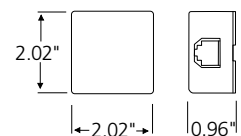

### ROUND TELEPHONE INSERTS

DESCRIPTION	WHITE	LT. ALMOND	IVORY
<b>[A]</b> Round Insert, 6P4C, 110 termination	—	—	41054-IDD
<b>[B]</b> Round Insert, 6P4C, screw terminal	—	—	40201-00I

### SURFACE-MOUNT TELEPHONE BOXES

Surface-Mount Box, 6P4C, screw terminal	4625A-24W	—	4625A-24I
Surface-Mount Box, 6P6C, screw terminal	4625A-26W	—	4625A-26I
<b>[C]</b> Surface-Mount Box, 8P8C, screw terminal	40278-00W	—	40278-00I
Surface-Mount Box, 8P8C w/ shorting bar, screw terminal, RJ-31X	—	40278-SBT	40278-SBI

# WALLPLATES & HOUSINGS | Telephone Wall-Phone Jacks



## TELEPHONE WALL-PHONE JACKS

- Wall-phone jacks available in 4- or 6-conductor models
- Screw terminal or quick-connect termination options
- Quick-connect products include plastic punchdown tool

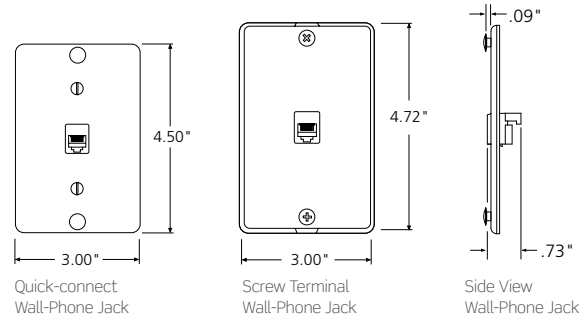

### WALL-PHONE JACK WALLPLATES - 110-STYLE

DESCRIPTION	WHITE	LT. ALMOND	IVORY	STAINLESS
<b>[A]</b> Wall-Phone Jack, 6P4C quick-connect, plastic w/ metal base	40253-00W	40253-00T	40253-00I	—
<b>[B]</b> Wall-Phone Jack, 6P4C quick-connect, stainless w/ metal base	—	—	—	40223-00S

### WALL-PHONE JACK WALLPLATES - SCREW TERMINAL

<b>[C]</b> Wall-Phone Jack, 6P4C screw terminal, plastic w/ metal base	40257-00W	—	40257-00I	—
<b>[D]</b> Wall-Phone Jack, 6P4C screw terminal, plastic w/ plastic base	40214-00W	40214-00T	40214-00I	—
Wall-Phone Jack, 6P6C screw terminal, stainless w/ metal base	—	—	—	40226-00S



## WALLPLATES & HOUSINGS | Decora® Wallplates

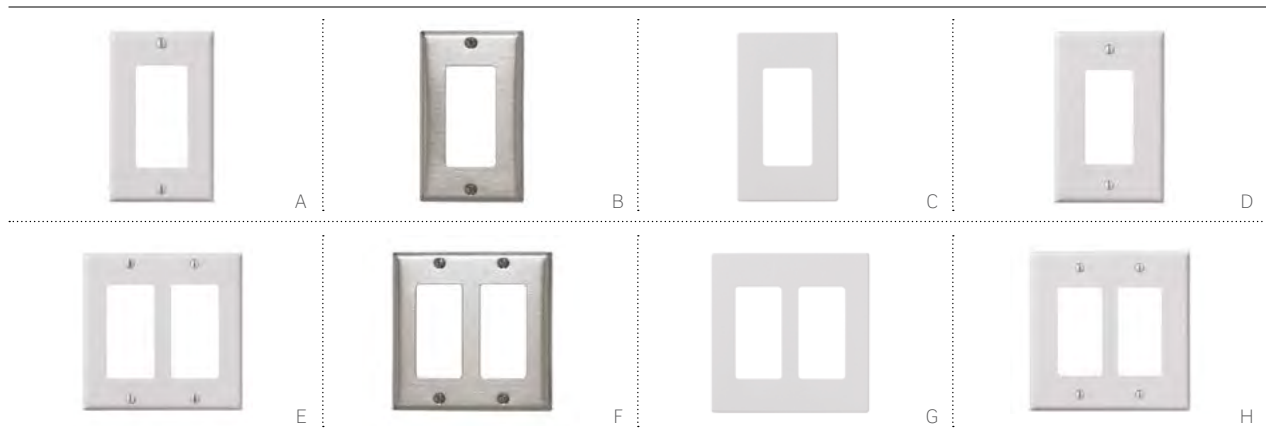

Standard Decora and Decora Plus wallplates accept a variety of inserts for voice, data, and video applications. The most common wallplates are shown here in a variety of materials and dimensions. Refer to page X15 for more detailed material properties. Decora Plus wallplates utilize a screwless design. Numerous additional configurations are available; call 800.722.2082 or visit [leviton.com](http://leviton.com) for more information.

### DECORA SINGLE-GANG WALLPLATES

DESCRIPTION	WHITE	LT. ALMOND	IVORY	GREY	BLACK	BROWN	STAINLESS
<b>[A]</b> Decora, standard size, urea	80401-00W	80401-00T	80401-00I	80401-0GY	80401-00E	80401-000	—
Decora, standard size, nylon	80401-0NW	80401-0NT	80401-0NI	80401-0NGY	80401-0NE	80401-00N	—
<b>[B]</b> Decora, standard size, stainless	—	—	—	—	—	—	84401-040
<b>[C]</b> Decora Plus, standard size, polycarbonate	80301-0SW	80301-0NT	80301-0SI	80301-0GY	80301-0SE	80301-00S	—
<b>[D]</b> Decora, midway, urea	80601-00W	80601-00T	80601-00I	80601-0GY	80601-00E	80601-000	—
Decora, midway, nylon	PJ26-00W	PJ26-00T	PJ26-00I	PJ26-0GY	PJ26-00E	PJ26-000	—

### DECORA DUAL-GANG WALLPLATES

<b>[E]</b> Decora, standard size, urea	80409-00W	80409-00T	80409-00I	80409-0GY	80409-00E	80409-000	—
Decora, standard size, nylon	80409-0NW	80409-0NT	80409-0NI	80409-0NGY	80409-0NE	80409-00N	—
<b>[F]</b> Decora, standard size, stainless	—	—	—	—	—	—	84409-040
<b>[G]</b> Decora Plus, standard size, polycarbonate	80309-0SW	80309-0ST	80309-0SI	80309-0GY	80309-0SE	80309-00S	—
<b>[H]</b> Decora, midway, urea	80609-00W	80609-00T	80609-00I	80609-0GY	80609-00E	80609-000	—
Decora, midway, nylon	PJ262-00W	PJ262-00T	PJ262-00I	PJ262-0GY	PJ262-00E	PJ262-000	—



# WALLPLATES & HOUSINGS | Duplex, Round Opening & Blank Wallplates

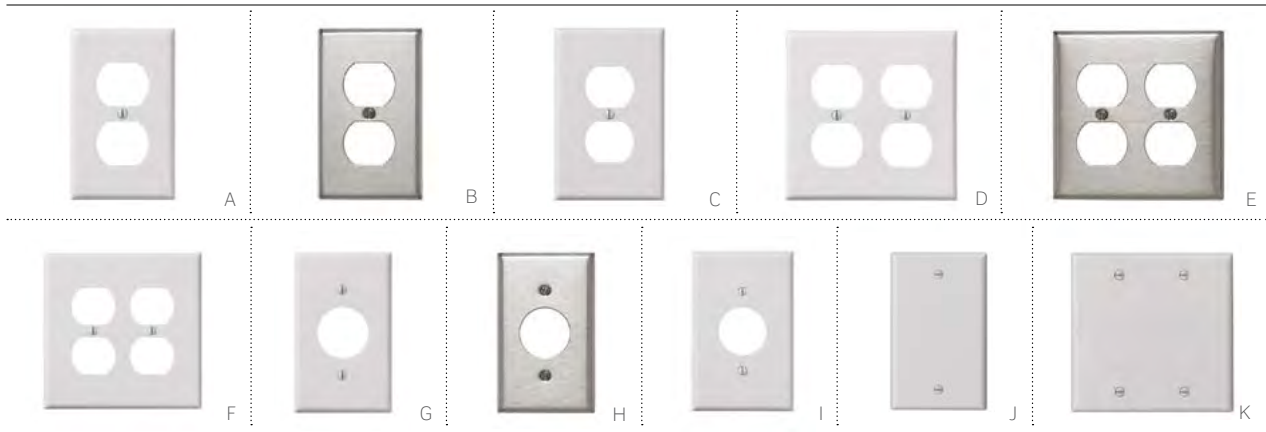

Standard 106-style duplex receptacle wallplates accept QuickPort® footprint inserts with either two or four openings (see page A51). Round opening wallplates accept 110-style or screw terminal inserts (see page A61). Stainless wallplates are constructed of type 302 stainless steel.

## DUPLEX SINGLE-GANG WALLPLATES

DESCRIPTION	WHITE	LT. ALMOND	IVORY	GREY	BLACK	BROWN	STAINLESS
<b>[A]</b> Duplex, standard size, urea	88003-000	78003-000	86003-000	87003-000	—	85003-000	—
Duplex, standard size, nylon	80703-00W	80703-00T	80703-00I	80703-0GY	80703-00E	80703-000	—
<b>[B]</b> Duplex, standard size, stainless	—	—	—	—	—	—	84003-040
<b>[C]</b> Duplex, midway, urea	80503-00W	80503-00T	80503-00I	80503-0GY	80503-00E	80503-000	—
Duplex, midway, nylon	00PJ8-00W	00PJ8-00T	00PJ8-00I	00PJ8-0GY	00PJ8-00E	00PJ8-000	—

## DUPLEX DUAL-GANG WALLPLATES

<b>[D]</b> Duplex, standard size, urea	88016-000	78016-000	86016-000	87016-000	—	85016-000	—
Duplex, standard size, nylon	80716-00W	80716-00T	80716-00I	80716-0GY	80716-00E	80716-000	—
<b>[E]</b> Duplex, standard size, stainless	—	—	—	—	—	—	84016-040
<b>[F]</b> Duplex, midway, urea	80516-00W	80516-00T	80516-00I	80516-0GY	80516-00E	80516-000	—
Duplex, midway, nylon	0PJ82-00W	0PJ82-00T	0PJ82-00I	0PJ82-0GY	0PJ82-00E	0PJ82-000	—

## ROUND OPENING SINGLE-GANG WALLPLATES

<b>[G]</b> Round Opening, standard size, urea	88004-000	78804-000	86004-000	—	—	85004-000	—
Round Opening, standard size, nylon	80704-00W	80704-00T	80704-00I	80704-0GY	80704-00E	80704-000	—
<b>[H]</b> Round Opening, standard size, stainless	—	—	—	—	—	—	84004-040
<b>[I]</b> Round Opening, midway, urea	80504-00W	80504-00T	80504-00I	—	—	80504-000	—
Round Opening, midway, nylon	00PJ7-00W	00PJ7-00T	00PJ7-00I	—	—	—	—

## SINGLE- AND DUAL-GANG BLANK WALLPLATES

<b>[J]</b> Single-Gang Blank Wallplate	88014-000	78014-000	86014-000	87014-000	—	85014-000	84014-040
<b>[K]</b> Dual-Gang Blank Wallplate	88025-000	78025-000	86025-000	87025-000	—	85025-000	84025-040



# COOPER



## copper tools & labeling

Leviton has everything you need to terminate and test our copper solutions. The ergonomic Palm Termination Tool, designed by and for installers, offers comfort-grip or rack-mounted positioning for termination, a sturdy connector holder, and a wire-supporting retainer. The Wire-Punchdown Termination Tool enables one-step punchdown of 110-style or 66 connecting block IDCs with a single push on the handle. Specialized termination tools, test equipment, crimping tools, and other accessories complete the collection.

### FEATURED PRODUCTS

Palm Termination Tool **A66**

Wire-Punchdown Termination Tool **A66**

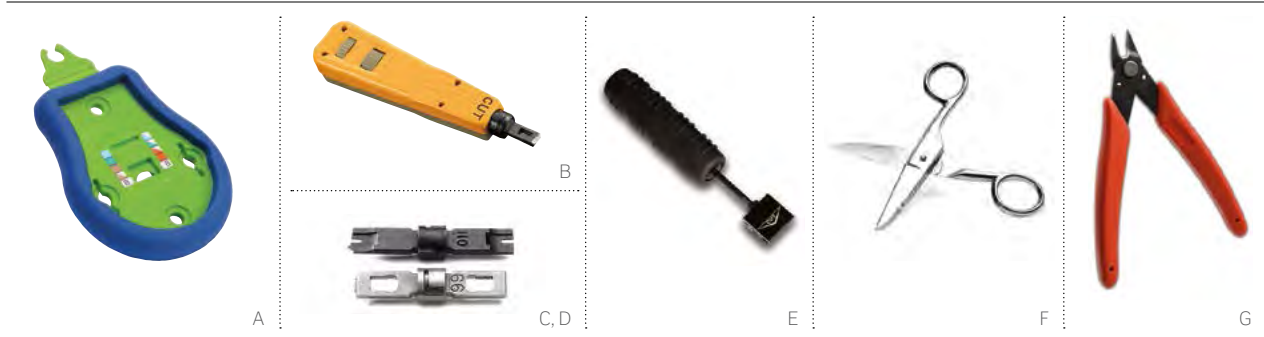

**PALM TERMINATION TOOL**

- Overmolded ergonomic soft grip
- Easy-to-see wiring labels
- Connector holders provide stability for punchdown
- Incorporated retainer supports cable during termination
- Integrated holes allow rack-mounting of the Palm Tool for patch panel terminations
- Compatible with all Leviton CAT 6A/6/5e and A/V connectors

**MULTI-PAIR TERMINATION TOOL**

- Designed for 110-style wiring blocks
- High-impact, spring-loaded handle for one-punch termination of multiple pairs
- "Blade-in" and "blade-out" options
- Includes 4-pair, CAT 6 head
- CAT 5e and 6 heads available individually

**WIRE-PUNCHDOWN / TERMINATION TOOL**

- Punches and trims each wire with just a single push of the handle
- Adjustable impact setting for minimal physical effort
- Spare blade storage in handle chamber
- Available in 110 IDC and 66 IDC
- Terminate 22-, 24-, or 26-gauge wire

**CUTTING TOOLS**

- Klein Tools® Electrician's Scissors are excellent for cutting and stripping copper cable as well as trimming center splines and rip cords
- Klein Tools Flush Cutter neatly trims individual cable wires flush to connector body to prevent shorts in metal housings (recommended for shielded connectors)

**TERMINATION TOOLS & BLADES**

DESCRIPTION	PART NO.
<b>[A]</b> Palm Termination Tool	47615-PTT
<b>[B]</b> Wire-Punchdown/Termination Tool (blades sold separately)	49553-814
<b>[C]</b> 110 IDC Blade	49553-110
<b>[D]</b> 66 IDC Blade	49553-066

**MULTI-PAIR TERMINATION TOOLS & ACCESSORIES**

<b>[E]</b> Mass-Termination Multi-Pair Tool Handle with CAT 6, 4-pair head	49553-TTH
Mass-Termination Replacement Head, CAT 6, 4-pair	49553-64H
Mass-Termination Replacement Head, CAT 5e, 5-pair	49553-55H

**CUTTING TOOLS**

<b>[F]</b> Klein Tools Electrician's Scissors	49886-SIS
<b>[G]</b> Klein Tools Flush Cutter (must be ordered in increments of 5)	49886-FCS

**JACKRAPID™ TOOL**



Free with purchase of 150 QuickPort connectors  
 6 bags of 25, Part Numbers:  
 61110-J\*6, 5G110-J\*5, 5G108-J\*5  
 See page A38.

# COPPER TOOLS & LABELING | Tools



A



B



C



D



E

## TONE TEST SET

- Low-voltage tester for continuity, shorts, and opens
- Talk battery for a communications line on a vacant pair
- Identifies tip and ring polarity, and line condition for clear line with dial tone, busy line, and ringing line
- Generates continuous or warble tone to trace pairs and locate broken pairs/cables in walls - use with Inductive Speaker Probe (below)

## INDUCTIVE SPEAKER PROBE

- Detects audible frequency tones for accurate tracing and identification of wires, cables, and metallic circuits

## MODULAR PLUG BREAKOUT ADAPTER

- For testing any 6- or 8-position modular jacks
- Works with the Tone Test Set

## COAXIAL CONNECTOR TOOLS

- Crimp coax onto RG-59 or RG-6 cables
- Rugged metal construction with cushioned handles

## MASTER COMPRESSION TOOL

- Terminates all Leviton coaxial compression connectors, including RCA and F-connectors
- Radial-style crimp compresses uniformly around connector body

### TONE TEST SET, INDUCTIVE SPEAKER PROBE & KITS

DESCRIPTION	PART NO.
<b>[A]</b> Tone Test Set (includes 9-volt battery)	49560-TTS
<b>[B]</b> Inductive Speaker Probe (includes 9-volt battery, one duckbill tip, and one needlepoint tip)	49561-SSP
<b>[C]</b> Kit containing one Tone Test Set with Belt Holster, and one Inductive Speaker Probe with Belt Holster	49562-TSK
MODULAR PLUG BREAKOUT ADAPTER	
<b>[D]</b> Modular Plug Breakout Adapter	40070-MDP
COAXIAL CONNECTOR TOOLS	
Crimping Tool for Coaxial Connectors	40988-000
<b>[E]</b> Master Compression Tool	40989-CPT



### WORK-AREA LABELING SOLUTIONS

DESCRIPTION	PART NO.
<b>[A]</b> QuickPort® Shutter Kit (50 shutters) White Label Kit	51084-ICN 51084-XLB
<b>[B]</b> Color Label Kit includes grey, orange, red, yellow, green, blue, purple, and brown (2 sheets of each color)	51084-CLB
<b>[C]</b> Labels and Windows for Wallplates & Housings on page A59 Labels and Windows for Stainless-Steel and Angled Wallplates on pages A49 and A50 Pre-printed Port Labels, black ink, 10 sheets per package	41080-IDW 43080-IDW 41080-LEB

### PATCH PANEL LABELING SOLUTIONS

<b>[D]</b> Adhesive Holder and Labels Kit for QuickPort Panels (supports 24 ports)	49257-QHD
<b>[E]</b> Adhesive Holder and Labels Kit for 110-Style Panels (supports 24 ports)	49257-I24
<b>[F]</b> Designation Kit Replacement for 110-Style Panels (supports 24 ports)	69585-IDL

### 110-STYLE LABELING SOLUTIONS

DESCRIPTION	PART NO.
CAT 6 Label Kit, 6/kit	41LBL-60W
CAT 5e Label Kit, 6/kit	41LBL-00W
Label Holder, 6/kit	41100-HLD

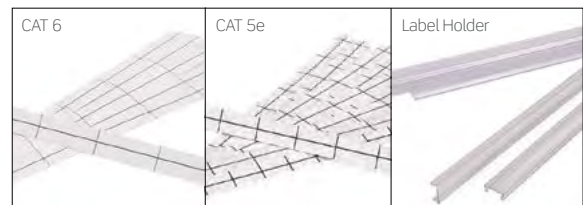

### SPOTLIGHT

#### Leviton Palm Termination Tool



Use the Leviton Palm Termination Tool (page A66) to quickly and easily punchdown connectors at the job site. The Palm Tool was designed with contractor input and offers an ergonomic comfort grip, increased connector stability, and integrated holes that allow rack mounting for QuickPort panel terminations. The Palm Tool is compatible with all CAT 6A/6/5e and QuickPort A/V connectors.

# FIBER SOLUTIONS



SECTION

B

## SECTION B CONTENTS

<b>INTRODUCTION</b>	<b>B3</b>	Common Configurations	<b>FLUSH-MOUNT ENCLOSURES &amp; PANELS</b>	<b>B39</b>	Introduction
	<b>B5</b>	Pre-Terminated Solutions		<b>B40</b>	Enclosures & Panels
	<b>B6</b>	Opt-X® Unity 40/100G			
<b>HDF3168 DISTRIBUTION SYSTEM</b>	<b>B7</b>	Introduction	<b>EQUIPMENT-SPECIFIC SOLUTIONS</b>	<b>B42</b>	Vertical Patching Brackets & Blade Replicators
	<b>B9</b>	Frame, Patch & Splice Decks		<b>B43</b>	Replicator® Enclosures
	<b>B10</b>	Adapter Plates & Cassettes		<b>B44</b>	Mainframe
<b>OPT-X HD</b>	<b>B11</b>	Introduction	<b>PRE-TERMINATED CABLE ASSEMBLIES &amp; PATCH CORDS</b>	<b>B45</b>	Introduction
	<b>B13</b>	Enclosures & Trays		<b>B46</b>	Make-to-Order Overview
	<b>B14</b>	Adapter Plates & Cassettes		<b>B47</b>	Opt-X Unity 40/100G MTP® Trunk Cables
<b>OPT-X</b>	<b>B15</b>	Introduction		<b>B49</b>	Standard Trunk Cables
	<b>B16</b>	Enclosures		<b>B50</b>	Secure Keyed LC Trunk Cables
	<b>B21</b>	Adapter Plates		<b>B51</b>	Opt-X Unity 40/100G MTP Harnesses
	<b>B23</b>	Cassettes		<b>B52</b>	Standard Harnesses
	<b>B25</b>	Splice Trays & Splice Holders		<b>B53</b>	Secure Keyed LC Harnesses
	<b>B26</b>	Accessories		<b>B54</b>	Opt-X Unity 40/100G Array Cords
<b>e2XHD</b>	<b>B27</b>	Introduction		<b>B55</b>	Premium Patch Cords & Pigtails
	<b>B29</b>	Panels, Cable Managers, Covers & Tools		<b>B56</b>	Economy Patch Cords & Pigtails
	<b>B30</b>	Cassettes	<b>CONNECTORS &amp; HOUSINGS</b>	<b>B58</b>	Secure Keyed LC Patch Cords & Pigtails
<b>LIGHTSPACE®</b>	<b>B31</b>	Introduction		<b>B59</b>	Introduction
	<b>B32</b>	Enclosures		<b>B60</b>	FastCAM® Connectors
	<b>B35</b>	Adapter Plates		<b>B61</b>	Fast-Cure® Connectors
	<b>B37</b>	Splice Trays & Holders		<b>B62</b>	Secure Keyed LC Connectors & Accessories
	<b>B38</b>	Splice Sleeves & Enclosure Accessories		<b>B63</b>	Fiber Optic Fan-Out Kits
				<b>B64</b>	QuickPort® Adapters
				<b>B65</b>	Multimedia Outlet System (MOS)
			<b>TOOLS &amp; CONSUMABLES</b>	<b>B67</b>	Introduction
				<b>B69</b>	Fiber Optic Tool Kits
				<b>B71</b>	Fiber Optic Tools
				<b>B72</b>	Consumable Products & Kits

# FIBER SOLUTIONS | Common Configurations

TYPE	ENCLOSURE SYSTEM	ADAPTER PLATES	CONNECTORS
<p><b>OM3 OM4</b></p> <p>50/125 <math>\mu</math>m Laser-Optimized Multimode Systems</p>	 <p>Opt-X Ultra<sup>®</sup> HD - See Page B13</p>  <p>Opt-X<sup>®</sup> 1000i HD - See Page B13</p>	 <p>Opt-X HDX Adapter Plates - See Page B14</p>	 <p>Field-Installable Connectors - See Page B60</p>
<p><b>OM1 OM2</b></p> <p>62.5/125 <math>\mu</math>m or 50/125 <math>\mu</math>m Multimode Systems</p>	 <p>Opt-X 1000i - See Page B17</p>  <p>Opt-X 500i - See Page B18</p>	 <p>Opt-X Adapter Plates - See Page B21</p>	 <p>Field-Installable Connectors - See Page B60</p>
<p><b>OS1 OS2</b></p> <p>Single-Mode System</p>	 <p>Opt-X Ultra - See Page B16</p>  <p>Opt-X 1000i - See Page B17</p>	 <p>Opt-X Adapter Plates - See Page B21</p>	 <p>Field-Installable Connectors - See Page B60</p>



# FIBER SOLUTIONS | Common Configurations

FIBER solutions

CABLE ASSEMBLIES	SPECIFICATION CHART						APPLICATIONS	
 <p>Fiber Patch Cords - See Page B55</p>		OM3 SYSTEM		OM4 SYSTEM		OM4+ SYSTEM		Data center infrastructure High-bandwidth enterprise, building automation, and security Medium-to-large enterprise networks High-performance computer clusters Migration path to Opt-X® Unity 40/100G VCSEL-based propagation
	<b>SPECIFICATION</b>	850 NM	1300 NM	850 NM	1300 NM	850 NM	1300 NM	
	Max. Attenuation (dB/km)	3.0	1.0	3.0	1.0	3.0	1.0	
	Overfill Launch Min. Bandwidth (MHz•km)	1500h	500 <sup>2</sup>	N/A	500 <sup>2</sup>	N/A	500 <sup>3</sup>	
	Effective Modal Bandwidth (EMB) (MHz•km)	2000 <sup>1</sup>	N/A	4700 <sup>1</sup>	N/A	4900	N/A	
	1G Transmission Distance (m)	1000	600	1040	600	1210	600	
	10G Transmission Distance (m)	300	300	550	300	600	300 <sup>5</sup>	
	40/100G Transmission Distance (m)	100	N/A	150	N/A	150 <sup>6</sup>	N/A	
<small><sup>1</sup> The effective modal bandwidth is determined based on an overfill launch (OFL) per ANSI/TIA-455-204, except on LOMM fiber types.  <sup>2</sup> 10GbE transmission at 1,300 nm only applies to 10GBASE-LX4 (CWDM).</small>								

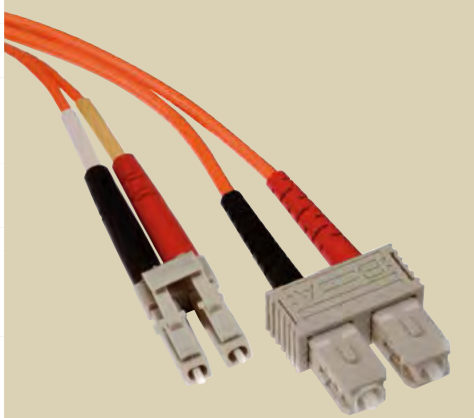
CABLE ASSEMBLIES	SPECIFICATION CHART				APPLICATIONS	
 <p>Fiber Patch Cords - See Page B56</p>		OM1 SYSTEM		OM2 SYSTEM		Building backbones and zone cabling Legacy cabling (62.5/125 μm fiber/OM1) Low-bandwidth enterprise, building automation, and security Small-to-medium enterprise networks LED-based propagation (62.5/125 μm fiber/OM1) LED- or laser-based propagation (50/125 μm fiber/OM2)
	<b>SPECIFICATION</b>	850 NM	1300 NM	850 NM	1300 NM	
	Max. Attenuation (dB/km)	3.5	1.0	3.0	1.0	
	Overfill Launch Min. Bandwidth (MHz•km)	200	500	950	500	
	1G Transmission Distance (m)	300	600	750	600	
	10G Transmission Distance (m)	36	300	150	300	

CABLE ASSEMBLIES	SPECIFICATION CHART				APPLICATIONS	
 <p>Fiber Patch Cords - See Pages B55 and B57</p>		OS1 SYSTEM		OS2 SYSTEM		Campus and building backbones Entrance facilities and equipment rooms Long distances Carrier equipment
	<b>SPECIFICATION</b>	1310 NM	1550 NM	1310 NM	1550 NM	
	Max. Attenuation (dB/km)	0.5	0.4	0.4	0.3	
	1G Transmission Distance (m)	5,000	N/A	5,000	N/A	
	10G Transmission Distance (m)	10,000	N/A	10,000	N/A	

## PRE-TERMINATED SOLUTIONS

Leviton recommends using pre-terminated trunks and harnesses whenever possible. With 100% factory testing and no need for field terminations or splices, installation time is reduced by up to 70%. Plug-n-play pre-terminated MTP® cassettes feature a space-saving design with a notched back for a smaller footprint and excellent radius control.

All Leviton pre-terminated solutions are made to your specifications: fiber and cable type, fiber count, connector type, breakout leg types, length, and more. More information on page B45.



### TRUNK CABLES (see pages B47-B50)

- MTP to MTP, including 12- and 24-fiber MTP connectors
- Discrete to discrete (LC, SC, ST, APC, and MU)
- MTP to discrete\*
- Single-mode, multimode, and laser-optimized multimode types available
- Secure Keyed LC trunks lock into any industry-compliant adapter or interface

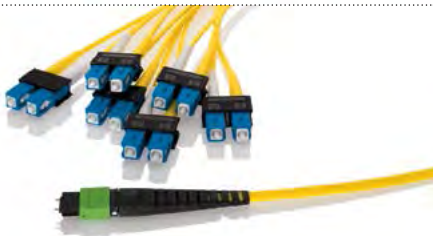

### HARNESSES (see pages B51-B53)

- MTP to MTP connectors
- MTP to discrete connectors (LC, SC, ST, and MU)\*
- Single-mode, multimode, and laser-optimized multimode types available
- Secure Keyed LC harnesses lock into any industry-compliant adapter or interface



### MTP CASSETTES (see pages B23-B24)

- 12- or 24-fiber MTP connectors on the back
- MTP connectors or discrete connectors on the front, including LC, SC, and MU\*
- Single-mode, multimode, and laser-optimized multimode types available

\* = LC/APC to SC/APC available for OS2.

## PRE-TERMINATED FIBER CABLING PERFORMANCE

CONNECTOR MATED PAIRS	MULTIMODE					SINGLE-MODE			MTP CASSETTES & HARNESSES	MULTIMODE		SINGLE-MODE	
	DUPLEX TYPICAL IL	DUPLEX MAX IL	12-FIBER STANDARD TYPICAL IL	12-FIBER STANDARD MAX IL	12- & 24-FIBER PREMIUM MAX IL	STANDARD TYPICAL IL	STANDARD MAX IL	PREMIUM MAX IL		12-FIBER PREMIUM MAX IL	24-FIBER PREMIUM MAX IL	12-FIBER STANDARD MAX IL	12-FIBER PREMIUM MAX IL
LC	0.15	0.25	—	—	—	0.25	0.35	—	LC	0.50	0.50	1.00	0.60
SC	0.20	0.25	—	—	—	0.25	0.35	—	SC	0.50	—	1.00	0.60
MU	0.15	0.25	—	—	—	0.25	0.35	—	MU	0.50	—	1.00	0.60
MTP	—	—	0.35	0.50	0.35	—	0.75	0.35					

### SPOTLIGHT

### Core & Edge Cassettes

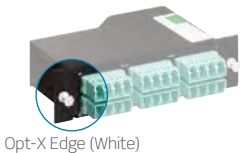
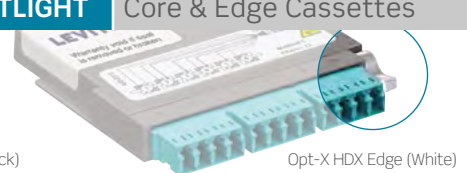
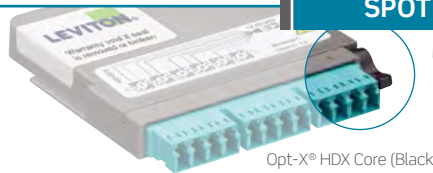

**In order to achieve proper polarity** when using Method B with two cassette configurations, Core and Edge cassettes must be used in pairs. This will simplify the design requirements for trunks and patch cords. For consistency, Core cassettes are typically placed at the main connection point, at or close to the main switching equipment. Edge cassettes are placed at the end connection point, near access layer equipment. For easy identification, Core cassette casing and pins are black, while Edge cassette casing and pins are white.



### PREPARE FOR 40/100G WITH THE OPT-X UNITY MULTIMODE SYSTEM

Leviton pre-terminated Opt-X Unity 40/100G laser-optimized multimode (LOMM) systems offer an ideal migration path to 40/100G speeds. They also meet the IEEE 802.3ba standard, which responds to the needs of data centers and enterprise networks that require speeds beyond 10 Gbps. The Opt-X Unity system features pre-terminated trunks, harnesses, array cords, and MTP® cassettes to help you future-proof your networks. See pages B47, B48, B51, and B54 for detailed product information.

- System of trunks, harnesses, and cassettes is 40/100G ready
- Industry-leading 24-fiber MTP system
- System uses best-in-class MTP premium multi-fiber connectors
- Available in laser-optimized multimode (OM3/OM4)
- Third-party verification of 40/100G channel performance

### OPT-X UNITY 40/100G SYSTEM

- 24-fiber MTP trunks
- 24-fiber MTP harnesses
- 24-fiber MTP array patch cords
- 24-fiber MTP cassettes
- 100G migration is available in Opt-X HD, Opt-X, and e2XHD footprints

### MIGRATION SOLUTIONS TO OPT-X UNITY 40/100G SYSTEM FROM EXISTING 10G NETWORKS

- Premium 12-fiber MTP trunks
- Premium 12-fiber MTP harnesses
- 24-fiber and premium 12-fiber array patch cords
- Premium 12-fiber MTP cassettes

### 40/100G MULTIMODE CHANNEL REQUIREMENTS (IEEE802.3BA)

OPTICAL FIBER TYPE	MAX. CHANNEL INSERTION LOSS	MAX. CONNECTOR LOSS	MAX DISTANCE
OM3	1.9 dB	1.5 dB	100 meters
OM4	1.5 dB	1.0 dB	150 meters

Contact [dcteam@leviton.com](mailto:dcteam@leviton.com) for help designing your 10/40/100G migration plan.

### COLOR-CODED BOOTS ON MTP

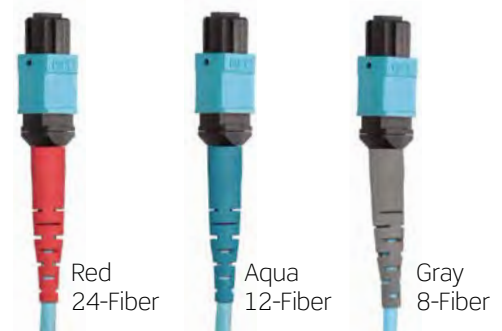

# FORBES



## FEATURED PRODUCTS

Frame, Patch & Splice Decks **B9**

Adapter Plates & Cassettes **B10**

## HDF3168 distribution system

The Leviton high-density HDF3168 Distribution System can handle up to 3168 fibers in just one tile of floor space. Ideal for service providers, central office facilities, large enterprise and cloud data centers, the HDF3168 Distribution System will reduce your patching footprint, free up valuable space, and save you money. Separated trunk, cable, and patch cord management improves accessibility and enables easy moves, adds, and changes. In addition, the system is fully scalable and modular, supporting consolidation and growth.



## INDUSTRY-LEADING DENSITY

**HDF3168 CAPACITY CHART**

CONNECTIVITY	MAX. FIBER STRANDS
LC	3,168
SC	1,584
12-Fiber MTP®	7,776
24-Fiber MTP	15,552

Chart based on use of 48-fiber trunks

The HDF system accomplishes such high density through its unique patch deck design. Each frame holds up to 22 patch decks, each configured with your choice of fiber cassettes, adapter plates, or splice trays.

## BUILT-IN CABLE MANAGEMENT & ROUTING

The frame keeps pathways clean and organized, using integrated cable management for minimum bend radius, better slack storage, and protection within the frame. Patch decks contain patch cord and MTP trunk routing for individual trays. And enhanced labeling improves deck and fiber identification to simplify moves, adds, or changes.

## SUPERIOR SCALABILITY

HDF3168 frames can be ganged together to handle future growth with easy pass-through cross-frame routing kits. And with 24-fiber MTP connectivity, they are ideal for migration from 10G to 40G to 100G and beyond.

## ADDITIONAL SECURITY

The HDF frame includes rear doors that lock to protect and conceal trunk cabling. Locking front doors (sold separately) are transparent to allow visibility.

## EASY ACCESSIBILITY

The frame's open design greatly reduces time and labor for maintenance, as it allows unobstructed access to patch cord connections on the cassettes and adapter plates. And the one-tile footprint makes it easier to access the space beneath a raised floor.

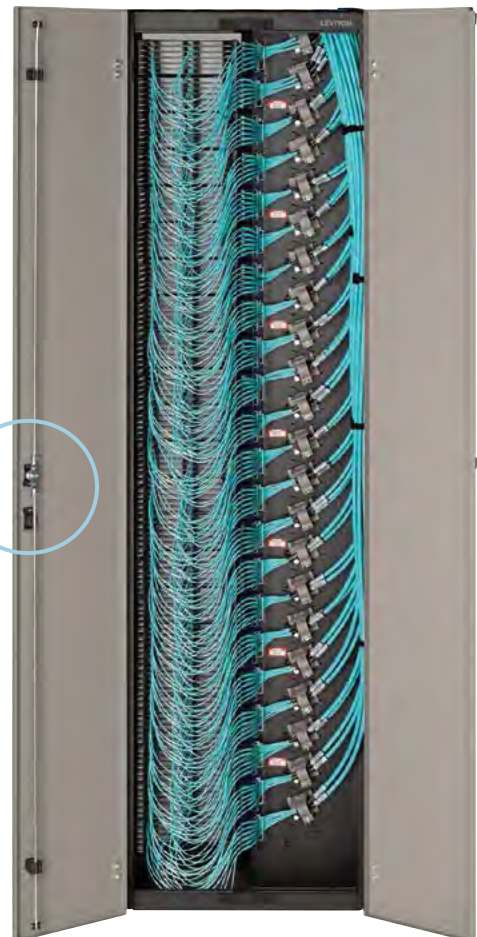

# HDF3168 DISTRIBUTION SYSTEM | Frame Patch & Splice Decks



## FIBER DISTRIBUTION FRAME

- Integrated cable management and routing solutions for minimum bend radius, better slack storage, and protection
- Holds up to 22 decks, each configured with cassettes, adapter plates, or splice trays
- Lockable rear doors included to protect and conceal trunk cabling
- Optional front doors (sold separately) are transparent and lockable for additional security
- Occupies only one 2-foot square tile
- Seismic rated to GR-63-CORE, Zone 4, UL 2046 Listed

## PATCH DECK

- 2RU height for up to 144 fibers (using LC) capacity
- Holds 6 independent sliding trays and accepts up to 12 single-width or 6 double-width MTP cassettes or adapter plates
- Magnifying port identification label holders for better visibility
- Integrated minimum bend radius protection

## SPLICE DECK

- Modular 3.5-inch-high deck accepts up to three independent splice trays
- Sliding trays are removable for ease of splicing
- Heat-shrink fusion splicing of individual 250  $\mu$ m or 900  $\mu$ m tight-buffer fibers for up to 144 fibers per deck
- Mass ribbon fusion splicing available as custom order

## HDX ADAPTER PLATES

- Connect to field-terminated backbone cabling or pre-terminated trunks
- Easy, one-hand installation and removal
- Offered in OM1/OM2, OM3/OM4, and OS2 fiber types
- LC, SC, and MTP styles in 6, 12, or up to 72/144-fiber configurations are available
- Visible sequential numbering to identify ports (for Tx and Rx)



## HDX MTP CASSETTES

- 12- or 24-fiber MTP configurations
- Select from LC or MTP connectors for 10G, 40G, or 100G applications
- Configure up to 48 fibers for 24 channels (10G) and 6 channels (40G)
- Easy to migrate from 10G to 40/100G when used with Opt-X<sup>®</sup> Unity trunks, harnesses, or patch cords
- Pre-terminated fiber eliminates the need for complicated field terminations and splices
- A variety of fiber types are available including single-mode, multimode, and laser-optimized multimode
- Easy, one-hand installation and removal

## 24-FIBER HIGH-DENSITY SPLICE TRAY

- Use with HDF3168 Splice Decks
- Protect and manage heat-shrink spliced fibers
- Heat-shrink splice sleeves included

# HDF3168 DISTRIBUTION SYSTEM | Cassettes & Adapter Plates

## HDF3168 FIBER OPTIC DISTRIBUTION SYSTEM

DESCRIPTION	PART NO.
<b>[A]</b> Fiber Distribution Frame, 7' H x 2' W x 2' D	F3168-22F
<b>[B]</b> Patch Deck, 2RU, empty (includes VELCRO® Brand ties and cable clamp kit)	F3168-DCK
<b>[C]</b> Splice Deck, 2RU, empty (includes VELCRO Brand ties, mesh sleeve, and cable clamp kit)	F3168-SPD
<b>[D]</b> Cross-Frame Routing Kit	F3168-CFR
<b>[E]</b> Front Doors Kit	F3168-FDR
Cable Clamp Kit	F3168-CCK
2RU Blank Panel	F3168-BLK

## HDX ADAPTER PLATES & SPLICE TRAY

Adapter Plate, OM1 & OM2, Quad LC (Beige), 12 fibers, phosphor bronze sleeve	5FUHD-2IL
<b>[F]</b> Adapter Plate, OM3 & OM4, Quad LC (Aqua), 12 fibers, zirconia ceramic sleeve	5FUHD-2QL
Adapter Plate, OS2, Quad LC (Blue), 12 fibers, zirconia ceramic sleeve	5FUHD-2LL
Adapter Plate, OM1 & OM2, Duplex SC (Beige), 6 fibers, phosphor bronze sleeve	5FUHD-6IC
Adapter Plate, OM3 & OM4, Duplex SC (Aqua), 6 fibers, zirconia ceramic sleeve	5FUHD-6QC
Adapter Plate, OS2, Duplex SC (Blue), 6 fibers, zirconia ceramic sleeve	5FUHD-6LC
Adapter Plate, 3 Duplex MTP Adapters (Black), key up/key up	5FUHD-6MB
<b>[G]</b> Adapter Plate, 3 Duplex MTP Adapters (Black), key up/key down	5FUHD-6MP
Adapter Plate, blank (Black)	5FUHD-BLK
<b>[H]</b> 24-fiber Heat Shrink Style Molded Splice Tray (includes 60 mm splice sleeves)	T5PLS-24F

## Make to order! HDF3168 FRAME OPTIONS

# OF PATCH DECKS	# OF CASSETTES OR ADAPTER PLATES PER PATCH DECK	FIBER COUNT	FIBER TYPE	CASSETTE/PLATE CONNECTOR TYPE (FRONT)	CASSETTE/PLATE CONNECTOR TYPE (REAR)	CASSETTE POLARITY	FRONT DOORS KIT
• 1-22	• 1-12	<ul style="list-style-type: none"> <li>• 12</li> <li>• 24</li> <li>• 48</li> </ul>	<ul style="list-style-type: none"> <li>• OM2</li> <li>• OM3</li> <li>• OM4</li> <li>• OS2</li> </ul>	<ul style="list-style-type: none"> <li>• LC</li> <li>• SC</li> <li>• MTP</li> </ul>	<ul style="list-style-type: none"> <li>• LC (Plate)</li> <li>• SC (Plate)</li> <li>• MTP (Plate)</li> <li>• 12-Fiber MTP</li> <li>• 24-Fiber MTP</li> </ul>	<ul style="list-style-type: none"> <li>• Method A</li> <li>• Method B (Core)</li> <li>• Method B (Edge)</li> <li>• Method C</li> </ul>	<ul style="list-style-type: none"> <li>• Yes</li> <li>• No</li> </ul>

## Make to order! HDF3168 PATCH DECK OPTIONS

# OF CASSETTES OR ADAPTER PLATES PER DECK	CASSETTE FIBER COUNT	FIBER TYPE	CASSETTE/PLATE CONNECTOR TYPE (FRONT)	CASSETTE/PLATE CONNECTOR TYPE (REAR)	CASSETTE POLARITY
• 1-12	<ul style="list-style-type: none"> <li>• 12</li> <li>• 24</li> <li>• 48</li> </ul>	<ul style="list-style-type: none"> <li>• OM2</li> <li>• OM3</li> <li>• OM4</li> <li>• OS2</li> </ul>	<ul style="list-style-type: none"> <li>• LC</li> <li>• SC</li> <li>• MTP</li> </ul>	<ul style="list-style-type: none"> <li>• LC (Plate)</li> <li>• SC (Plate)</li> <li>• MTP (Plate)</li> <li>• 12-Fiber MTP</li> <li>• 24-Fiber MTP</li> </ul>	<ul style="list-style-type: none"> <li>• Method A</li> <li>• Method B, Core</li> <li>• Method B, Edge</li> <li>• Method C</li> </ul>

## Make to order! HDX MTP CASSETTE OPTIONS

FIBER TYPE	FIBER COUNT	CONNECTOR TYPE (FRONT)	MTP TYPE (REAR)	POLARITY
• OM2	• 12	• LC	• M1 (12F)	• Method A
• OM3	• 24	• MTP	• M2 (24F)	• Method B, Core
• OM4	• 48			• Method B, Edge
• OS2				• Method C

For Method B polarity, you must order one each of the Core and Edge cassettes.

For assistance customizing your cassettes, please visit [leviton.com/configurator](http://leviton.com/configurator) or call Tech Support at 800.824.3005.

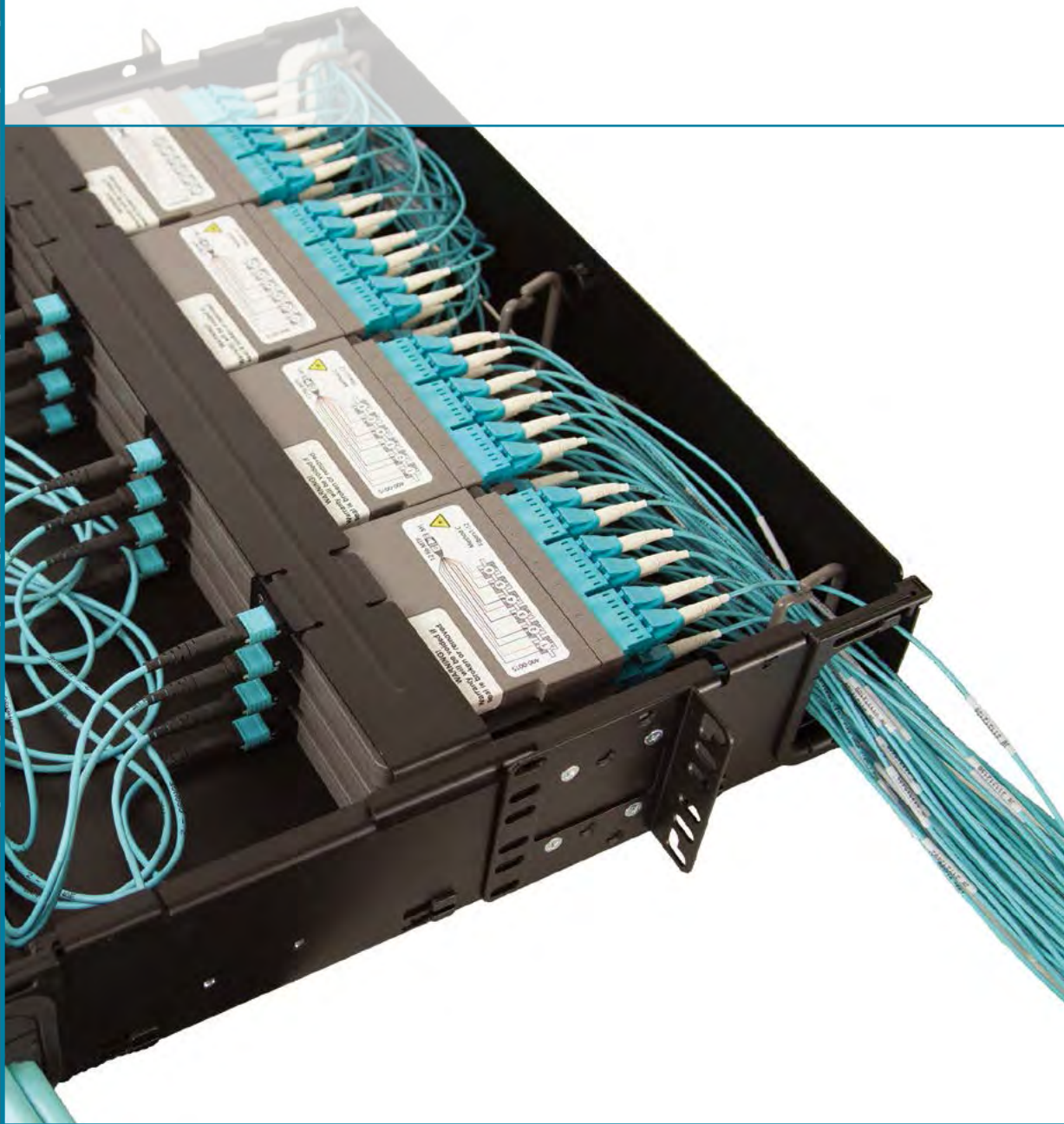

## FEATURED PRODUCTS

Enclosures & Trays **B13**

Adapter Plates & Cassettes **B14**

## Opt-X<sup>®</sup> HD enclosure system

Data centers and telecommunications rooms are rapidly outgrowing their footprints to meet increasing network demands. The new Leviton Opt-X HD Enclosure System features compact, high-density cassettes and adapter plates with LC or MTP<sup>®</sup> connectors that fit into high-density enclosures to create a scalable platform for enterprise and data center applications. This allows you to maintain low costs while benefiting from higher density: 33% more density with LC connectors or 50% with MTP connectors.



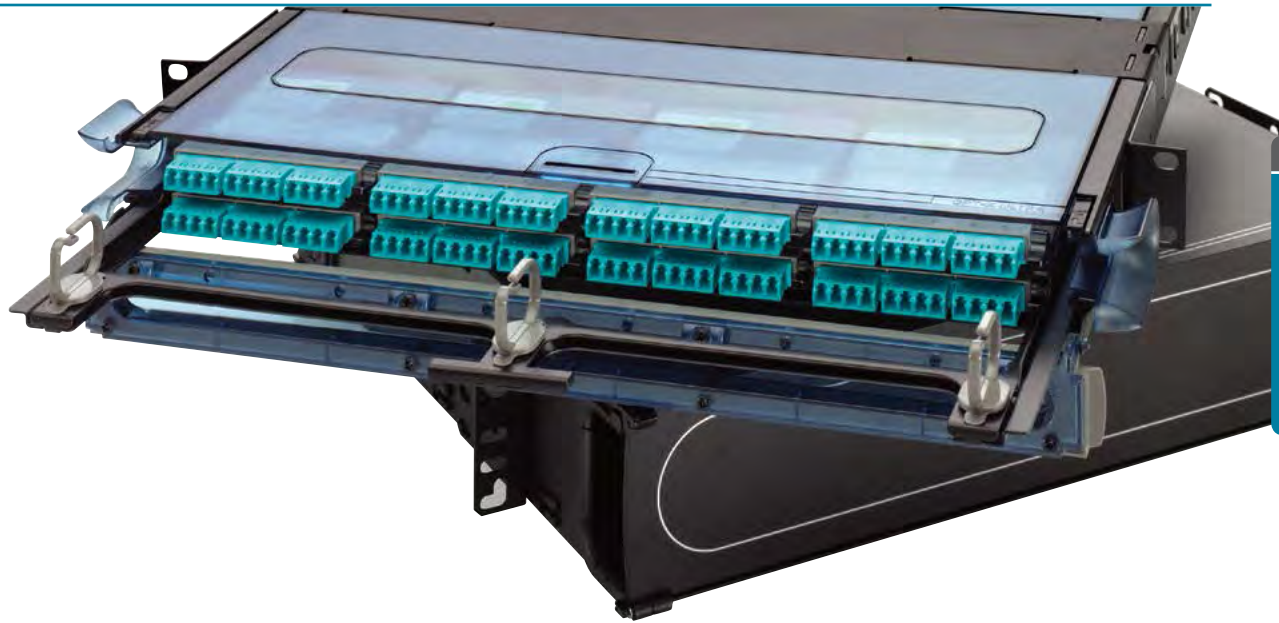

Opt-X HD enclosure system

FIBER

## A PART OF THE OPT-X FAMILY

Opt-X fiber enclosures, adapter plates, MTP® cassettes, and cable assemblies offer flexible connection and storage options. Featuring compact Opt-X HD cassettes and adapter plates that fit into high-density enclosures, this innovative system creates a scalable platform for comprehensive enterprise and data center applications.

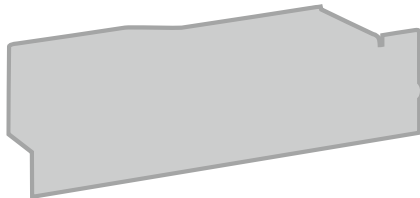
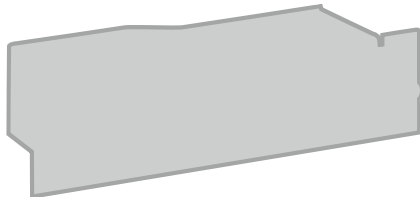

Capacity of 1RU Opt-X Enclosure with MTP-LC Cassette

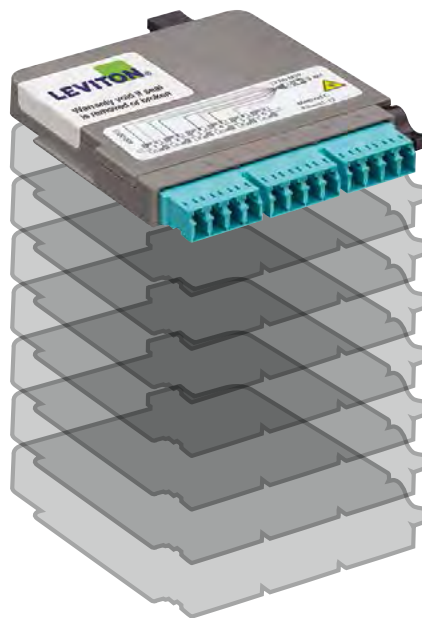

Capacity of 1RU Opt-X HD Enclosure with MTP-LC Cassette

**33%**  
more fiber density  
in the **same space**  
with LC connectors

# OPT-X® HD ENCLOSURE SYSTEM | Enclosures, Trays & Accessories

Opt-X HD enclosure system

FIBER



## OPT-X ULTRA® HD FIBER RACK-MOUNT ENCLOSURE

Not your typical black box, the stylish and innovative design features a sliding tray that can be removed completely for easy field termination and accessibility. The enclosures utilize new high-density adapter plates and MTP® cassettes. Innovative cable management options allow for easy moves, adds, and changes. Additionally, the 17-inch depth is perfect for high-density fiber applications such as MDA, HDA, and EDA spaces in data centers.

## OPT-X 1000i HD FIBER RACK-MOUNT ENCLOSURE

The 1000i HD Enclosure has a simplified look and similar features to the Opt-X Ultra HD Enclosure. This enclosure utilizes new high-density adapter plates and MTP cassettes, and is ideal for data centers as well as smaller facilities, such as equipment rooms and telecommunication rooms.

## OPT-X HD ENCLOSURE ACCESSORIES

- Cable clamp kits minimize excessive pulling, bending, and crushing
- Supports easy cable identification and decreases the need for tie-wraps inside the enclosure
- Creates a transition point from jacketed cable to buffered fiber or subunits
- Ideal for vertical strain relief and strain relief at the top or bottom of a rack/cabinet



## RECOMMENDED APPLICATIONS:

- Data Centers
- Equipment Room
- Entrance Facility
- Telecommunications Room
- 19" and 23" Racks and Cabinets

OPT-X HD ENCLOSURES & TRAYS					
DESCRIPTION	MAXIMUM CAPACITY				PART NO.
	FIBERS (USING LC)	ADAPTER PLATES	OR	MTP CASSETTES	
<b>[A]</b> Opt-X Ultra HD 1RU Enclosure, empty, with sliding tray	96	8		8	5R1UH-S08
Opt-X Ultra HD 2RU Enclosure, empty, with sliding tray	192	16		16	5R2UH-S16
Opt-X 1000i HD 1RU Enclosure, empty, with sliding tray	96	8		8	5R1UM-S08
<b>[B]</b> Opt-X 1000i HD 2RU Enclosure, empty, with sliding tray	192	16		16	5R2UM-S16
<b>[C]</b> Retrofit sliding tray, 1RU (for use with Opt-X Ultra or 1000i)	—	—		—	5R1UR-TRY
Retrofit sliding tray, 2RU (for use with Opt-X Ultra or 1000i)	—	—		—	5R2UR-TRY

ACCESSORIES	
DESCRIPTION	PART NO.
Universal Opt-X Clamp Kit, Single Cable Grommet (for enclosure mounting)	5RCMP-KIT
Universal Opt-X Clamp Kit, Multiple Cable Grommet (for enclosure mounting)	5RCMP-KT2
Universal Clamp Kit, Single and Multiple Cable Grommet (for rack mounting)	5RCMR-KIT

New



A

New



B

New



1x12 MTP® Fiber to 12-Fiber LC Cassette

## HDX ADAPTER PLATES

- Connect to field-terminated backbone cabling or pre-terminated trunks
- Easy, one-hand installation and removal
- Offered in OM1/OM2, OM3/OM4, and OS2 fiber types
- LC, SC, and MTP styles in 6, 12, or up to 72/144 fiber configurations are available
- Visible sequential numbering to identify ports (for Tx and Rx)

## HDX MTP CASSETTES

- 12- or 24-fiber MTP configurations
- Select from LC or MTP connectors for 10G, 40G, or 100G applications
- Configure up to 48 fibers for 24 channels (10G) and 6 channels (40G)
- Easy to migrate from 10G to 40/100G when used with Opt-X Unity trunks, harnesses, or patch cords
- Pre-terminated fiber eliminates the need for complicated field terminations and splices
- A variety of fiber types are available including single-mode, multimode, and laser-optimized multimode
- Easy, one-hand installation and removal



## HDX ADAPTER PLATES

DESCRIPTION	PART NO.
Adapter Plate, OM1 & OM2, Quad LC (Beige), 12 fibers, phosphor bronze sleeve	5FUHD-2IL
<b>[A]</b> Adapter Plate, OM3 & OM4, Quad LC (Aqua), 12 fibers, zirconia ceramic sleeve	5FUHD-2QL
Adapter Plate, OS2, Quad LC (Blue), 12 fibers, zirconia ceramic sleeve	5FUHD-2LL
Adapter Plate, OM1 & OM2, Duplex SC (Beige), 6 fibers, phosphor bronze sleeve	5FUHD-6IC
Adapter Plate, OM3 & OM4, Duplex SC (Aqua), 6 fibers, zirconia ceramic sleeve	5FUHD-6QC
Adapter Plate, OS2, Duplex SC (Blue), 6 fibers, zirconia ceramic sleeve	5FUHD-6LC
Adapter Plate, 3 Duplex MTP Adapters (Black), key up/key up	5FUHD-6MB
<b>[B]</b> Adapter Plate, 3 Duplex MTP Adapters (Black), key up/key down	5FUHD-6MP
Adapter Plate, blank (Black)	5FUHD-BLK

## Make to order! HDX CASSETTE OPTIONS

FIBER TYPE	FIBER COUNT	CONNECTOR TYPE (FRONT)	MTP TYPE (REAR)	POLARITY
• OM2	• 12	• LC	• M1 (12F)	• Method A
• OM3	• 24	• MTP	• M2 (24F)	• Method B, Core
• OM4	• 48			• Method B, Edge
• OS2				• Method C

For MTP Method B polarity, you must order one each of the Core and Edge cassettes.

For assistance customizing your cassettes, please visit [leviton.com/configurator](http://leviton.com/configurator) or call Tech Support at 800.824.3005.

# FORBES

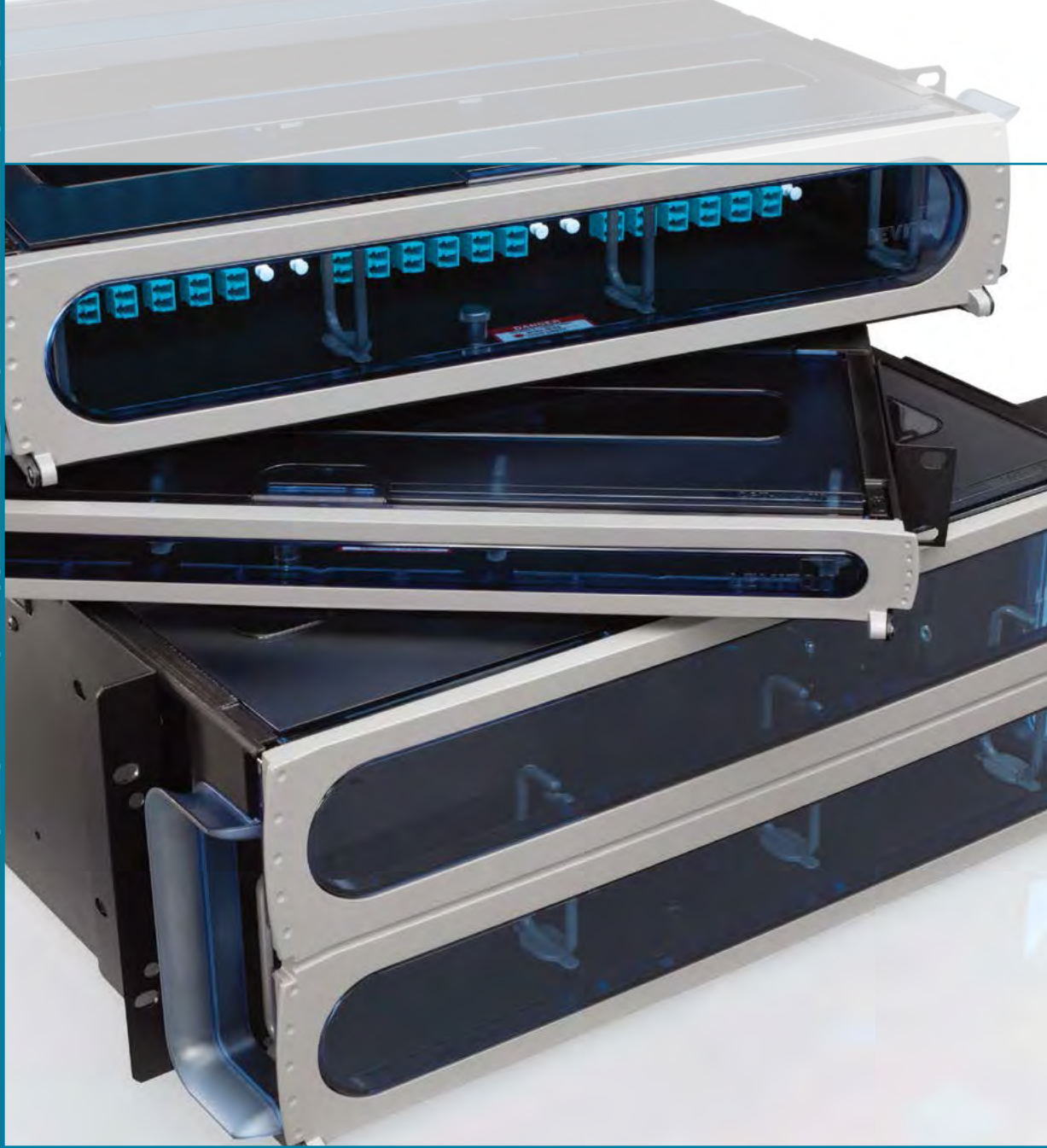

## FEATURED PRODUCTS

Enclosures **B16**

Adapter Plates **B21**

Cassettes **B23**

## Opt-X<sup>®</sup> enclosure system

The Opt-X Enclosure System is a flexible solution designed for easy installation and maintenance. Whether it's the Opt-X Ultra for data centers or 1000i and 500i for medium and small enterprise applications, each comes packed with features for better cable organization and maintainability. In addition, Opt-X adapter plates, MTP<sup>®</sup> cassettes, and cable assemblies offer the flexible connection and storage options to meet any project need.



**OPT-X ULTRA 1RU/2RU/4RU RACK-MOUNT ENCLOSURES**

- Stylish and innovative design for today's most advanced networks and settings
- Sliding tray removes completely from enclosure to facilitate field terminations and splicing
- Sliding tray with front and rear stop glides forward and backward, providing accessibility to front and rear of bulkhead after installation
- 17" depth for high-density fiber termination and/or splicing
- Front saddles pivot for improved patch cord routing and organization
- Removable transparent hinged doors and slide-away covers allow easy access during install and visibility of interior after install
- Patch cord bend radius guides minimize macro bending
- Stackable and adjustable fiber rings simplify cable management
- Constructed of durable polycarbonate plastic and black powder-coated 16-gauge steel
- Multiple mounting bracket positions for 19" or 23" rack and cabinet installation (23" 1RU mounting bracket sold separately)
- Also accepts LightSpace® (LGX® footprint) adapter plate mounting cassettes by special order
- 1RU and 2RU accept the Retrofit Sliding Tray, sold separately, for higher density applications using Opt-X HDX MTP Cassettes
- 1RU and 2RU are "intelligent ready", accept Intact Fiber Upgrade Kits



**RECOMMENDED APPLICATIONS:**

- Data Centers
- Equipment Room
- Entrance Facility
- Telecommunications Room
- 19" and 23" Racks and Cabinets

**OPT-X ULTRA RACK-MOUNT ENCLOSURES**

DESCRIPTION	MAXIMUM CAPACITY					PART NO.
	FIBERS (USING LC)	ADAPTER PLATES	AND	SPLICE TRAYS*	OR MTP® CASSETTES	
<b>[A]</b> Opt-X Ultra, 1RU, empty, sliding tray	72	3		3	3	5R1UH-S03
<b>[B]</b> Opt-X Ultra, 2RU, empty, sliding tray	144	6		6	6	5R2UH-S06
<b>[C]</b> Opt-X Ultra, 4RU, empty, sliding tray	288	12		12	12	5R4UH-S12

\* = Maximum splice tray capacity is limited by height of selected splice tray. See page X13 for splice tray dimension and selection guide. See pages B21-B24 for list of Opt-X adapter plates and cassettes.

**Make to order! OPT-X ULTRA RACK-MOUNT ENCLOSURE OPTIONS**

ENCLOSURE STYLE	ADAPTER PLATES OR MTP CASSETTE SELECTION	ADAPTER PLATE QTY	FIBER TYPE	ADAPTER TYPE & PIGTAIL SELECTION	SPLICE TRAY STYLE	NO. OF SPLICE TRAYS	SECURITY OPTIONS	CABLE CLAMP KIT	MOUNTING EAR POSITION
<ul style="list-style-type: none"> <li>• 1U Opt-X</li> <li>• 2U Opt-X</li> <li>• 4U Opt-X</li> </ul>	<ul style="list-style-type: none"> <li>• 6 fibers (SC, ST)</li> <li>• 8 fibers (SC, ST)</li> <li>• 12 fibers (LC, SC, ST)</li> <li>• 16 fibers (LC only)</li> <li>• 24 fibers (LC only)</li> <li>• MTP Cassette - 12 fibers (LC, SC, ST)</li> <li>• MTP Cassette - 24 fibers (LC only)</li> </ul>	<ul style="list-style-type: none"> <li>• 1-12</li> </ul>	<ul style="list-style-type: none"> <li>• OM1</li> <li>• OM2</li> <li>• OM3</li> <li>• OM4</li> <li>• OS2</li> </ul>	<ul style="list-style-type: none"> <li>• LC</li> <li>• LC + pigtail</li> <li>• SC</li> <li>• SC/APC</li> <li>• SC + pigtail</li> <li>• SC/APC + pigtail</li> <li>• ST</li> <li>• ST + pigtail</li> </ul>	<ul style="list-style-type: none"> <li>• Heat shrink, foam holders, up to 12 fibers (molded tray)</li> <li>• Heat shrink, plastic holders, up to 12 fibers (molded tray)</li> <li>• Bare fusion, plastic holders, up to 12 fibers (metal tray)</li> <li>• Heat shrink, plastic holders, up to 24 fibers (molded tray)</li> </ul>	<ul style="list-style-type: none"> <li>• 1-12</li> <li>• None</li> </ul>	<ul style="list-style-type: none"> <li>• Locking front door</li> <li>• Locking rear door</li> <li>• Both doors</li> <li>• None</li> </ul>	<ul style="list-style-type: none"> <li>• Yes</li> <li>• No</li> </ul>	<ul style="list-style-type: none"> <li>• 19"</li> <li>• 23"</li> </ul>

For assistance customizing your enclosures, please visit [leviton.com/configurator](http://leviton.com/configurator) or call Tech Support at 800.824.3005.



**OPT-X 1000i 1RU/2RU/3RU/4RU ENCLOSURES**

- Sliding tray glides forward (with stop) and backward, and removes (1RU, 2RU) for easy field terminations and splicing
- 15" depth for high-density fiber termination and/or splicing
- Constructed of 16-gauge steel, powder-coated black
- 19" or 23" enclosure rack-mount option (23" 1RU mounting bracket sold separately)
- Enclosures protrude 4.5" from mounting ears to align with Versi-Duct® Cable Management System
- Accepts Opt-X adapter plates and/or Opt-X MTP® cassettes
- LightSpace® (LGX® footprint) compatible versions also available by special order
- Locking door option available on front, rear, or both doors
- Accessory kit consists of cable ties, mounting ear screws, and port ID label
- 1RU and 2RU accept the Retrofit Sliding Tray, sold separately, for higher density applications using Opt-X HDX MTP Cassettes



**RECOMMENDED APPLICATIONS:**

- Equipment Room
- Telecommunications Room
- 19" and 23" Racks and Cabinets

DESCRIPTION	MAXIMUM CAPACITY					PART NO.
	FIBERS (USING LC)	ADAPTER PLATES	AND	SPLICE TRAYS*	OR	
Opt-X 1000i, 1RU, empty	72	3		3		5R1UM-F03
<b>[A]</b> Opt-X 1000i, 1RU, empty, sliding tray	72	3		3		5R1UM-S03
Opt-X 1000i, 2RU, empty	144	6		6		5R2UM-F06
Opt-X 1000i, 2RU, empty, sliding tray	144	6		6		5R2UM-S06
Opt-X 1000i, 3RU, empty, horizontal^	216	9		12		5R3UM-F09
<b>[B]</b> Opt-X 1000i, 3RU, empty, vertical°	288	12		12		5R3UM-F12
<b>[C]</b> Opt-X 1000i, 4RU, empty, vertical°	288	12		12		5R4UM-F12
Opt-X 1000i, 4RU, empty, horizontal^	360	15		12		5R4UM-F15

° = Vertical adapter plate/cassette orientation    ^ = Horizontal adapter plate/cassette orientation  
 \* = Maximum splice tray capacity is limited by height of selected splice tray. See page X13 for splice tray dimension and selection guide.  
 See pages B21-B24 for list of Opt-X adapter plates and cassettes.

Make to order! OPT-X 1000i RACK-MOUNT ENCLOSURE OPTIONS									
ENCLOSURE STYLE	ADAPTER PLATES OR MTP CASSETTE SELECTION	ADAPTER PLATE QTY	FIBER TYPE	ADAPTER TYPE & PIGTAIL SELECTION	SPLICE TRAY STYLE	NO. OF SPLICE TRAYS	SECURITY OPTIONS	CABLE CLAMP KIT	MOUNTING EAR POSITION
<ul style="list-style-type: none"> <li>• 1RU Opt-X</li> <li>• 2RU Opt-X</li> <li>• 1RU or 2RU Opt-X w/tray</li> <li>• 3RU or 4RU Opt-X w/horizontal adapter plates</li> <li>• 3RU or 4RU Opt-X w/ vertical adapter plates</li> </ul>	<ul style="list-style-type: none"> <li>• 6 fibers (SC, ST)</li> <li>• 8 fibers (SC, ST)</li> <li>• 12 fibers (LC, SC, ST only)</li> <li>• 16 fibers (LC only)</li> <li>• 24 fibers (LC only)</li> <li>• MTP Cassette - 12 fibers (LC, SC, ST)</li> <li>• MTP Cassette - 24 fibers (LC only)</li> </ul>	<ul style="list-style-type: none"> <li>• 1-15</li> </ul>	<ul style="list-style-type: none"> <li>• OM1</li> <li>• OM2</li> <li>• OM3</li> <li>• OM4</li> <li>• OS2</li> </ul>	<ul style="list-style-type: none"> <li>• LC</li> <li>• LC + pigtail</li> <li>• SC</li> <li>• SC/APC</li> <li>• SC + pigtail</li> <li>• SC/APC + pigtail</li> <li>• ST</li> <li>• ST + pigtail</li> </ul>	<ul style="list-style-type: none"> <li>• Heat shrink, foam holders, up to 12 fibers (molded tray)</li> <li>• Heat shrink, plastic holders, up to 12 fibers (molded tray)</li> <li>• Bare fusion, plastic holders, up to 12 fibers (metal tray)</li> <li>• Heat shrink, plastic holders, up to 24 fibers (molded tray)</li> </ul>	<ul style="list-style-type: none"> <li>• 1-12</li> <li>• None</li> </ul>	<ul style="list-style-type: none"> <li>• Locking front door</li> <li>• Locking rear door</li> <li>• Both doors</li> <li>• None</li> </ul>	<ul style="list-style-type: none"> <li>• Yes</li> <li>• No</li> </ul>	<ul style="list-style-type: none"> <li>• 19"</li> <li>• 23"</li> </ul>

For assistance customizing your enclosures, please visit [leviton.com/configurator](http://leviton.com/configurator) or call Tech Support at 800.824.3005.

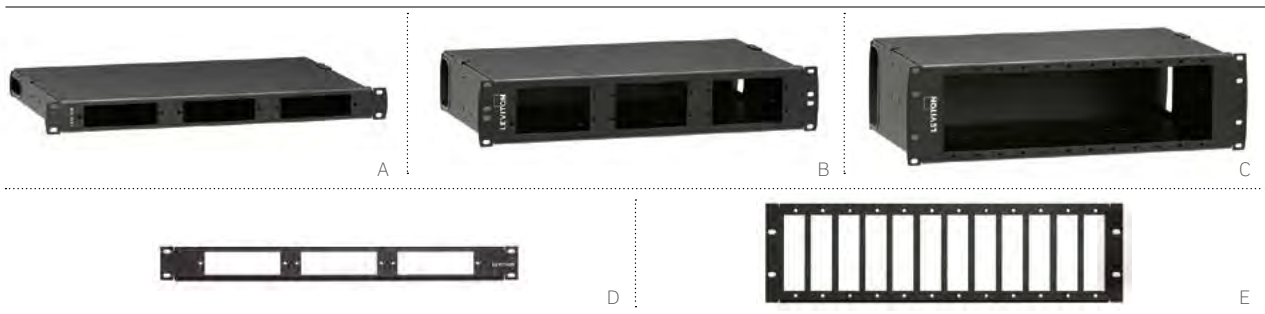

**OPT-X 500i FLUSH-MOUNT RACK ENCLOSURES**

- Flush-mount adapter bulkhead makes moves, adds, and changes easy
- One-piece removable cover allows for complete accessibility to the back of the enclosure
- Constructed of 16-gauge steel, powder-coated black
- Accepts Opt-X adapter plates and/or Opt-X MTP® cassettes
- Accepts injection-molded splice trays and 4" x 7" metal splice trays
- Enclosure is capable of storing up to 3 meters of 900 µm tight-buffered fiber per adapter
- Accessory kit consists of cable ties, mounting ear screws, and port ID label
- Optional universal clamp kits (for installation on side of enclosure or on rack post)
- 1RU and 3RU flush-mount panels accept Opt-X adapter plates and mount to 19" racks and cabinets
- Optional add-on patch cord cable management tray (sold separately) uses existing rack unit

**RECOMMENDED APPLICATIONS:**

- Equipment Room
- Telecommunications Room
- 19" Racks and Cabinets

**OPT-X 500i RACK-MOUNT ENCLOSURES**

DESCRIPTION	MAXIMUM CAPACITY					PART NO.
	FIBERS (USING LC)	ADAPTER PLATES	AND	SPLICE TRAYS*	OR	
<b>[A]</b> Opt-X 500i, 1RU Enclosure, empty	72	3		3		5R1UL-F03
<b>[B]</b> Opt-X 500i, 2RU Enclosure, empty	144	6		6		5R2UL-F06
<b>[C]</b> Opt-X 500i, 3RU Enclosure, empty	288	12		12		5R3UL-F12
<b>[D]</b> Opt-X 500i, 1RU Panel, empty	72	3		N/A		5R1UE-OPX
<b>[E]</b> Opt-X 500i, 3RU Panel, empty	288	12		N/A		5R3UE-OPX

\* = Maximum splice tray capacity is limited by height of selected splice tray. See page X13 for splice tray dimension and selection guide. See pages B21-B24 for list of Opt-X adapter plates and cassettes.

**SPOTLIGHT** Patch Cord Management Tray



**Patch Cord Management Trays** help route and organize cables on Opt-X 500i enclosures. The trays feature identification labels and front saddles that pivot for easier routing. Because they mount directly to the front of the enclosures, they do not require additional rack space. Available in 1RU and 2RU sizes, the trays can be used with any Leviton 1RU flush-mount MTP enclosure and 2RU trays can be used with 3RU 500i enclosures.



A



B



C

## OPT-X 1000 WALL-MOUNT FIBER OPTIC ENCLOSURES

- Self-healing grommet material protects cable and minimizes dust build-up
- Adjustable fiber management rings easily attach to mounting studs
- Ground terminal lug provides grounding option or cable strain relief
- Cutout on side of enclosure allows access to adapter bulkhead when doors are open
- Door options: split with single lock on service side (optional lock available to install on customer side), solid with or without single lock on customer side
- Constructed of 16-gauge steel, powder-coated black

### RECOMMENDED APPLICATIONS:

Telecommunications Room

Equipment Room

### OPT-X 1000 SMALL WALL-MOUNT ENCLOSURES

DESCRIPTION	MAXIMUM CAPACITY					PART NO.
	FIBERS (USING LC)	ADAPTER PLATES	AND	SPLICE TRAYS*	OR	
Small, empty, solid metal door, no lock	48	2		N/A		5W110-00N
<b>[A]</b> Small, empty, split metal door and one lock/key	48	2		N/A		5W120-00N
Small, empty, solid metal door and one lock/key	48	2		N/A		5W170-00N

### OPT-X 1000 MEDIUM WALL-MOUNT ENCLOSURES

Medium, empty, solid metal door, no lock	96	4		6		5W310-00N
<b>[B]</b> Medium, empty, split metal door and one lock/key	96	4		6		5W320-00N
Medium, empty, solid metal door and one lock/key	96	4		6		5W370-00N

### OPT-X 1000 LARGE WALL-MOUNT ENCLOSURES

<b>[C]</b> Large, empty, solid metal door, no lock	288	12		6		5W710-00N
Large, empty, split metal door and one lock/key	288	12		6		5W720-00N
Large, empty, solid metal door and one lock/key	288	12		6		5W770-00N

### ACCESSORIES

Lock and Key

5L000-L0K

\* = Maximum splice tray capacity is limited by height of selected splice tray. See page X13 for splice tray dimension and selection guide. See pages B21-B24 for list of Opt-X adapter plates and cassettes.

## SPOTLIGHT

### Fiber-to-the-Home Point of Entry Box



The Leviton Fiber-to-the-Home (FTTH) Point of Entry Box is designed for applications in Multi Dwelling Units (MDUs) and single-family homes. It provides a convenient location to terminate incoming fiber from the service provider to pigtails at the subscriber's premises. The box includes an SC/APC adapter with two dust caps, as well as two splice sleeves. It can be mounted in the Structured Media® enclosure or as a stand-alone unit on a wall, and comes with an adhesive magnet for easy installation and place adjustments. See page F12 for details.





A



Fiber Plug-n-Play Patch Panel



VertiGO Rack-Mount Plug-n-Play Patch Panels

### VERTIGO ZERO-U PATCH PANELS

- All styles sold empty, with either QuickPort® or Opt-X style openings
- Zero-U uses no rack space
- Low-profile design fully covers connections
- Improves cabinet center airflow by routing rear cable along outer edges
- Styles with 3" and 6" channels\* provide additional cable management space
- Hinged doors provide easy access to termination field
- Magnified label holders make for easy reading
- Supports copper and fiber installations

\*Not available as stand-alone pieces and must be purchased as a complete unit.

### VERTIGO ZERO-U VIDEO



Watch the training video at [leviton.com/videos](http://leviton.com/videos): "How to Mount Leviton's VertiGO Patch Panel."

### VERTIGO RACK-MOUNT PLUG-N-PLAY PATCH PANELS

- Pre-configured for fast network deployment
- Adjustable mounting ears provide five unique offset distances for enhanced horizontal cable management
- Integrated cable manager
- Accepts all Opt-X adapter plates, allowing for a mix of copper, fiber, and multimedia connectivity
- Provides either MTP® Plug-n-Play or discrete point termination
- All VertiGO Rack-Mount Plug-n-Play Patch Panels sold as custom configurations; call 800.722.2082 for more information

### VERTIGO FIBER PLUG-N-PLAY PATCH PANELS

- Pre-configured for fast network deployment
- Mounts vertically to standard 19" racks or cabinets while consuming no horizontal rack space
- Accepts all Opt-X adapter plates, allowing for a mix of copper, fiber, and multimedia connectivity
- Internal metal divider provides separation of copper and fiber cabling
- Provides either MTP Plug-n-Play or discrete point termination
- Can mount to the back rails of racks and cabinets, ladder tray, walls, or in under-floor applications for maximum versatility
- All VertiGO Fiber Plug-n-Play Patch Panels sold as custom configurations; call 800.722.2082 for more information

### VERTIGO ZERO-U PATCH PANELS

DESCRIPTION	PART NO.
Opt-X Adapter Plate Zero-U, panel only	49280-AP0
<b>[A]</b> Opt-X Adapter Plate Zero-U, panel with 3" cable channel	49280-AP3
Opt-X Adapter Plate Zero-U, panel with 6" cable channel	49280-AP6

For VertiGO panels with QuickPort openings, see page A19.

# OPT-X® ENCLOSURE SYSTEM | Adapter Plates

Opt-X enclosure system

FIBER



## OPT-X ADAPTER PLATES

- Unique design works with Opt-X series enclosures, including the advanced Opt-X Ultra®, as well as Opt-X 1000i, Opt-X 500i, and wall-mount Opt-X 1000
- Captive push/pull fasteners allow for quick, tool-free installation and removal
- Available in 6- to 24-fiber plates for LC, SC, and ST
- Available in 72- to 192-fiber plates for MTP®
- Fits in all standard Opt-X rack-mount and wall-mount enclosures and VertiGO® panels
- MTP and LC adapter plates with shutters available by special order
- 6-position QuickPort® Adapter plates (item T) accept all QuickPort modules

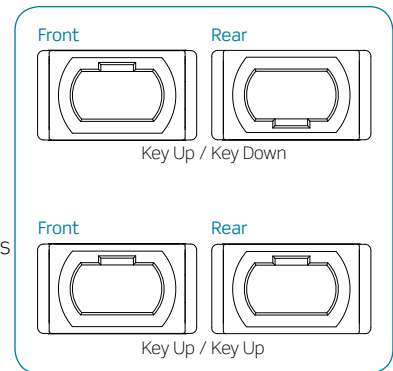

## OPT-X RACK-MOUNT ENCLOSURE CAPACITY

1RU FOR ULTRA 1000i & 500i	2RU FOR ULTRA 1000i & 500i	3RU FOR 1000i	3RU FOR 500i	4RU FOR ULTRA 1000i
Holds up to 3 adapter plates	Holds up to 6 adapter plates	Holds up to 9/12 adapter plates	Holds up to 12 adapter plates	Holds up to 12/15 adapter plates
6-pk Dplx LC = up to 36 fibers 6-pk Quad LC = up to 72 fibers 8-pk Dplx LC = up to 48 fibers 3-pk Dplx SC = up to 18 fibers 6-pk Dplx SC = up to 36 fibers 6-pk ST = up to 18 fibers 8-pk ST = up to 24 fibers	6-pk Dplx LC = up to 72 fibers 6-pk Quad LC = up to 144 fibers 8-pk Dplx LC = up to 96 fibers 3-pk Dplx SC = up to 36 fibers 6-pk Dplx SC = up to 72 fibers 6-pk ST = up to 36 fibers 8-pk ST = up to 48 fibers	6-pk Dplx LC = up to 108/144 fibers 6-pk Quad LC = up to 216/288 fibers 8-pk Dplx LC = up to 144/192 fibers 3-pk Dplx SC = up to 54/72 fibers 6-pk Dplx SC = up to 108/144 fibers 6-pk ST = up to 54/72 fibers 8-pk ST = up to 72/96 fibers	6-pk Dplx LC = up to 144 fibers 6-pk Quad LC = up to 288 fibers 8-pk Dplx LC = up to 192 fibers 3-pk Dplx SC = up to 72 fibers 6-pk Dplx SC = up to 144 fibers 6-pk ST = up to 72 fibers 8-pk ST = up to 96 fibers	6-pk Dplx LC = up to 144/180 fibers 6-pk Quad LC = up to 288/360 fibers 8-pk Dplx LC = up to 192/240 fibers 3-pk Dplx SC = up to 72/90 fibers 6-pk Dplx SC = up to 144/180 fibers 6-pk ST = up to 72/90 fibers 8-pk ST = up to 96/120 fibers

## OPT-X WALL-MOUNT ENCLOSURE CAPACITY

SMALL	MEDIUM	LARGE
Holds up to 2 adapter plates	Holds up to 4 adapter plates	Holds up to 12 adapter plates
6-pk Dplx LC = up to 24 fibers 6-pk Quad LC = up to 48 fibers 8-pk Dplx LC = up to 32 fibers 3-pk Dplx SC = up to 12 fibers 6-pk Dplx SC = up to 24 fibers 6-pk ST = up to 12 fibers 8-pk ST = up to 16 fibers	6-pk Dplx LC = up to 48 fibers 6-pk Quad LC = up to 96 fibers 8-pk Dplx LC = up to 64 fibers 3-pk Dplx SC = up to 24 fibers 6-pk Dplx SC = up to 48 fibers 6-pk ST = up to 24 fibers 8-pk ST = up to 32 fibers	6-pk Dplx LC = up to 144 fibers 6-pk Quad LC = up to 288 fibers 8-pk Dplx LC = up to 192 fibers 3-pk Dplx SC = up to 72 fibers 6-pk Dplx SC = up to 144 fibers 6-pk ST = up to 72 fibers 8-pk ST = up to 96 fibers

## OPT-X PRECISION-MOLDED FIBER ADAPTER PLATES

DESCRIPTION	PART NO.
<b>[A]</b> Adapter Plate (beige), 62.5 µm MM (OM1), Duplex LC, 12-fiber, zirconia ceramic sleeve	5F100-2IL
<b>[B]</b> Adapter Plate (black), 50 µm MM (OM2), Duplex LC, 12-fiber, zirconia ceramic sleeve	5F100-2EL
<b>[C]</b> Adapter Plate (aqua), 50 µm LOMM (OM 3 & 4), Duplex LC, 12-fiber, zirconia ceramic sleeve	5F100-2QL
<b>[D]</b> Adapter Plate (blue), SM (OS2), Duplex LC, 12-fiber, zirconia ceramic sleeve	5F100-2LL
<b>[E]</b> Adapter Plate (green), SM (OS2), Duplex LC/APC, 12-fiber, zirconia ceramic sleeve	5F100-2VL
<b>[F]</b> Adapter Plate (beige), 62.5 µm MM (OM1), Quad LC, 24-fiber, zirconia ceramic sleeve	5F100-4IL
<b>[G]</b> Adapter Plate (black), 50 µm MM (OM2), Quad LC, 24-fiber, zirconia ceramic sleeve	5F100-4EL
<b>[H]</b> Adapter Plate (aqua), 50 µm LOMM (OM3 & 4), Quad LC, 24-fiber, zirconia ceramic sleeve	5F100-4QL
<b>[I]</b> Adapter Plate (blue), SM (OS2), Quad LC, 24-fiber, zirconia ceramic sleeve	5F100-4LL
Plates (beige), 62.5 µm MM (OM1), Duplex SC, 6-fiber, zirconia ceramic sleeve	5F100-6IC
Plates (black), 50 µm MM (OM2), Duplex SC, 6-fiber, zirconia ceramic sleeve	5F100-6EC
Plates (aqua), 50 µm MM (OM3 & OM4), Duplex SC, 6-fiber, zirconia ceramic sleeve	5F100-6QC
Plates (blue), SM (OS2), Duplex SC, 6-fiber, zirconia ceramic sleeve	5F100-6LC
Plates (green), SM (OS2), Duplex SC/APC, 6-fiber, zirconia ceramic sleeve	5F100-6VC
<b>[J]</b> Adapter Plate (beige), 62.5 µm MM (OM1), Duplex SC, 12-fiber, zirconia ceramic sleeve	5F100-2IC
<b>[K]</b> Adapter Plate (black), 50 µm MM (OM2), Duplex SC, 12-fiber, zirconia ceramic sleeve	5F100-2EC
<b>[L]</b> Adapter Plate (aqua), 50 µm LOMM (OM3 & OM4), Duplex SC, 12-fiber, zirconia ceramic sleeve	5F100-2QC
<b>[M]</b> Adapter Plate (blue), SM (OS2), Duplex SC, 12-fiber, zirconia ceramic sleeve	5F100-2LC
<b>[N]</b> Adapter Plate (green), SM (OS2), Duplex SC/APC, 12-fiber, zirconia ceramic sleeve	5F100-2VC
<b>[O]</b> Adapter Plate (black), ST MM/SM, 6-fiber, zirconia ceramic sleeve	5F100-6MT
<b>[P]</b> Adapter Plate (black), ST MM/SM, 8-fiber, zirconia ceramic sleeve	5F100-8MT
<b>[Q]</b> Adapter Plate (black), Blank	5F100-PLT

## OPT-X FIBER ADAPTER PLATES, METAL

Adapter Plate (black), OM1 & 2, Duplex LC (beige), 16-fiber, phosphor bronze sleeve	5F100-16P
<b>[R]</b> Adapter Plate (black), OM3 & 4, Duplex LC (aqua), 16-fiber, zirconia ceramic sleeve	5F100-16A
Adapter Plate (black), OS2, Duplex LC (blue), 16-fiber, zirconia ceramic sleeve	5F100-16Z
<b>[S]</b> Adapter Plate (black), 6 simplex MTP, key up/key down	5F100-6MP
Adapter Plate (black), 6 simplex MTP, key up/key up	5F100-6MB
Adapter Plate (black), 8 simplex MTP, key up/key down	5F100-8MP
Adapter Plate (black), 8 simplex MTP, key up/key up	5F100-8MB
<b>[T]</b> Adapter Plate (black), 6-position QuickPort®, Empty	5F100-6QP

Additional adapter plate configurations available. Please contact Tech Support at 800.824.3005 for more information.

### SPOTLIGHT

### Opt-X Precision-Molded Adapter Plates



Traditional adapter plate construction typically uses independent couplers inserted in a metal plate that often results in a “rattling” of components. Leviton Opt-X Adapter Plates eliminate rattling and loose-fitting adapters by using precision molding and integrated adapters, improving the overall performance, functionality, and quality of construction. All multimode and single-mode Opt-X plates feature zirconia ceramic sleeves, providing high performance and low insertion loss (recommended for applications requiring 10 Gbps and higher).

# OPT-X® ENCLOSURE SYSTEM | MTP® Premium Cassettes

Opt-X enclosure system

FIBER



A



B



MTP-LC Cassette w/ Shutters

New



MTP-LC, 24-fiber, OM4 (OM4 violet color option)

## MTP PREMIUM CASSETTES

- Plug-n-play cassette eliminates the need for field termination or splices
- Each cassette supports up to 24 fibers (LC)
- Bend-insensitive fiber used in OM3/OM4 cassette
- All premium 12-fiber MTP cassettes use low-loss MTP connectors
- Low insertion loss of 0.5 dB maximum
- 100% factory tested with test results included with each cassette
- See specific enclosure pages for MTP cassette capacity
- Violet color option available for OM4



### OPT-X CASSETTES, COMMON CONFIGURATIONS

DESCRIPTION	PART NO.
MTP Cassette, 12-fiber MTP-LC	FM-*012CACO+
<b>[A]</b> MTP Cassette, 12-fiber MTP-SC	FM-*012BACO+
<b>[B]</b> MTP Cassette, 24-fiber 2x12F MTP-LC	FM-*024CACO+

\* = fiber type: A = OS2, E = OM3, or F = OM4

+ = Polarity: A=Method A, C=Method C, BC = Method B (core), BE = Method B (edge). For Method B, each channel must have 1 core and 1 edge cassette.

### Make to order! MTP PREMIUM CASSETTE OPTIONS

FIBER TYPE	FIBER COUNT	CONNECTOR TYPE	MTP FIBER COUNT	CASSETTE COLOR	POLARITY
• OM1	• 12	• LC	• 12	• Black (standard)	• MTP Method A
• OM2	• 24	• LC (w/shutters)		• Beige	• MTP Method B, Core, Black Latches
• OM3		• LC/APC			• MTP Method B, Edge, White Latches
• OM4 (aqua)		• LC/APC (w/shutters)			• MTP Method C
• OM4 (violet)		• SC			
• OS2		• SC/APC			
		• MU			

For MTP Method B polarity, you must order one each of the Core and Edge cassettes.

For assistance customizing your cassettes, please visit [leviton.com/configurator](http://leviton.com/configurator) or call Tech Support at 800.824.3005.

## The Industry's Best Service & Support

**LISA DOBBINS**  
Inside Sales Lead

For the past 10 years, Lisa has forged strong international relationships and delivered outstanding customer service. Working with industry leaders across product management, production, and warehouse and distribution, she continually supports new processes to enhance efficiency and optimize communication. Additionally, Lisa has played a key role in streamlining customer support practices, advancing quicker product and information turnarounds to meet a wide range of customer project needs.



A



B

Two Configurations Available:



1x24-Fiber MTP (back view)



2x12-Fiber MTP (back view)

### OPT-X UNITY 40/100G MTP CASSETTES

- Available in Opt-X style footprint
- Allows easy migration from 10G to 40G or 100G
- Each cassette supports up to 48 fibers using MTP-MTP, or 24 fibers using MTP-LC
- All cassettes use either 24-fiber or 12-fiber low-loss MTP connectors
- Bend-insensitive fiber used in OM3/OM4 cassettes
- MTP-MTP cassettes are used with MTP array cords on page B54
- See specific enclosure pages for MTP cassette capacity
- Latches are color coded: black = Core, white = Edge
- Unity cassettes are Make-to-Order only

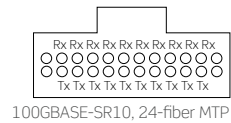
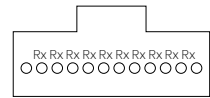
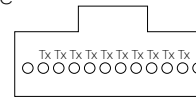
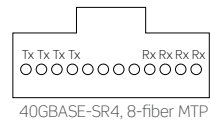

### OPT-X UNITY 40/100G MTP CASSETTES, COMMON CONFIGURATIONS

DESCRIPTION	PART NO.
<b>[A]</b> MTP Cassette, 24-fiber, 2x12F MTP-3x8F MTP, Method B	FM -*024NCC0B†
<b>[B]</b> MTP Cassette, 48-fiber, 2x24F MTP-6x8F MTP, Method B	FM -*048NDC0B†
MTP Cassette, 24-fiber, 24F MTP-LC, Method B	FM -*024CDC0B†
MTP Cassette, 24-fiber, 24F MTP-3x8F MTP, Method B	FM -*024NDC0B†

\* = fiber type: OM3 (E), or OM4 (F) † = polarity: Core (C), or Edge (E) **Each channel must have one Core and Edge cassette.** Other MTP polarity options available.

For assistance customizing your cassettes, please visit [leviton.com/configurator](http://leviton.com/configurator) or call Tech Support at 800.824.3005.

### SPOTLIGHT 10/40/100G Fiber Testing

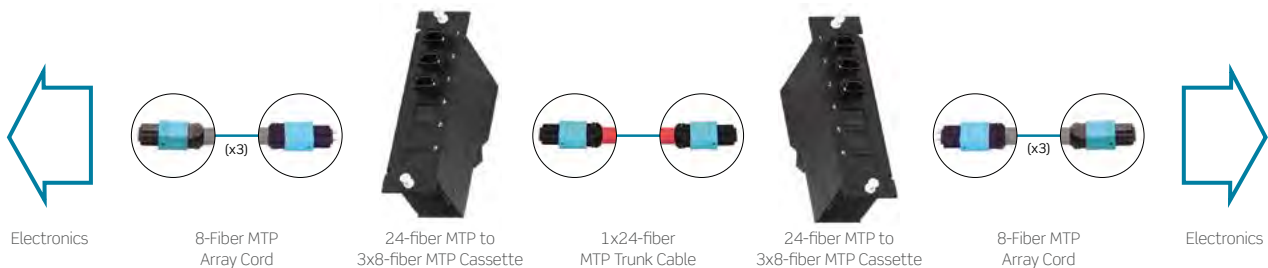

Leviton is the first manufacturer to have an independent fiber channel verification completed. Our OM3 fiber connectivity has been tested and shown to exceed performance requirements to support 10GBASE-S, and the Opt-X Unity System has been shown to exceed the performance requirements for 40GBASE-SR4 and 100GBASE-SR10 standards. Both tests were performed by Intertek (ETL) to ensure compliance to the maximum insertion loss and link distance requirements specified in the ANSI/TIA-568-C.3 and IEEE 802.3ba standards. The channels were configured to show typical data center applications as well as maximum flexibility. This type of testing assures customers that our fiber solutions will support their needs as they migrate to 10G, 40G, or 100G.



# OPT-X® ENCLOSURE SYSTEM | Splice Trays & Splice Holders

Opt-X enclosure system

FIBER



## INJECTION-MOLDED SPLICE TRAYS

- 12-fiber mini and 24-fiber high-density splice trays
- Protect and manage heat-shrink style spliced fibers
- Heat-shrink splice sleeves included
- Ratchet-action clamps with foam-rubber padding minimize damage to fibers
- Compatible with Leviton Opt-X Ultra®, Opt-X 1000i, and Opt-X 1000 series, plus LightSpace® wall-mount enclosures
- 12-fiber splice tray compatible with Leviton network interface devices (NIDs); when stacking splice trays, only use lids on top tray

## OPT-X 12- & 24-FIBER SPLICE MODULES

- Integrates fiber adapter bulkhead (12 or 24 fibers) and splice holders, eliminating the need of splice trays
- Individual compartments provide slack storage and bend radius guides for respective backbone cable, 900 µm tight buffer pigtails, and fusion-spliced fibers
- Modular design allows for ease of maintenance of individual spliced fiber and allows for scaling up without impacting existing fibers
- Available in single-mode (OS2) UPC & APC and laser-optimized multimode (OM3) fiber types

## SPLICE HOLDERS

- 6- and 12-fiber designs in foam and solid plastic options
- Mini, micro, and mechanical options available
- Styles accommodate the entire range of Leviton fusion splice sleeves

INJECTION-MOLDED SPLICE TRAYS	
DESCRIPTION	PART NO.
<b>[A]</b> 12-fiber Mini, 3.74" W x 5.59" L x 0.56" H (includes 14 heat-shrink splice sleeves)	T5PLS-12F
<b>[B]</b> 24-fiber High-Density, 4.5" W x 7.63" L x 0.50" H (includes 26 heat-shrink splice sleeves)	T5PLS-24F
<b>[C]</b> Splice Tray Mounting Hardware Kit	SPLMT-HKT
OPT-X 12- & 24-FIBER SPLICE MODULES*	
Opt-X 12-Fiber LC Splice Module	SPLCS-12x
Opt-X 24-Fiber LC Splice Module	SPLCS-24x
<b>[D]</b> Opt-X 12-Fiber SC Splice Module	SPSCS-12x
SPLICE HOLDERS	
Splice Holder, heat shrink (black plastic), 6-fiber capacity	FSHHS-P06
Splice Holder, heat shrink (black plastic), 8-fiber capacity	FSHHS-P08
Splice Holder, heat shrink (black foam), 6-fiber capacity	FSHSL-F06
Splice Holder, mini sleeves (black foam), 6-fiber capacity	FSHMI-F06
Splice Holder, micro sleeves (black foam), 6-fiber capacity	FSHMR-F06
Splice Holder, bare fusion, 12-fiber capacity	FSHBF-P12
Splice Holder, heat shrink (LGX® footprint), 6-fiber capacity	FSHAT-F06
Splice Holder, ribbon, 6 position, 72-fiber capacity	FSHRB-F06
FUSION SPLICE SLEEVES	
Mini Splice Tray, heat shrink	T47HS-P06
Mini Splice Tray w/ standoff, heat shrink	5T000-00T
Standard Splice Tray, bare fusion	T4LBF-P06

\* = Additional fiber types and connector combinations are available. For assistance ordering, call 800.824.3005.

x = OM3 (A), OS2 (L), APC OS2 (V)

Note: Splice tray mounting hardware sold separately except as noted. Additional configurations available including mechanical splice. Contact inside sales at 800.824.3005 for more information.

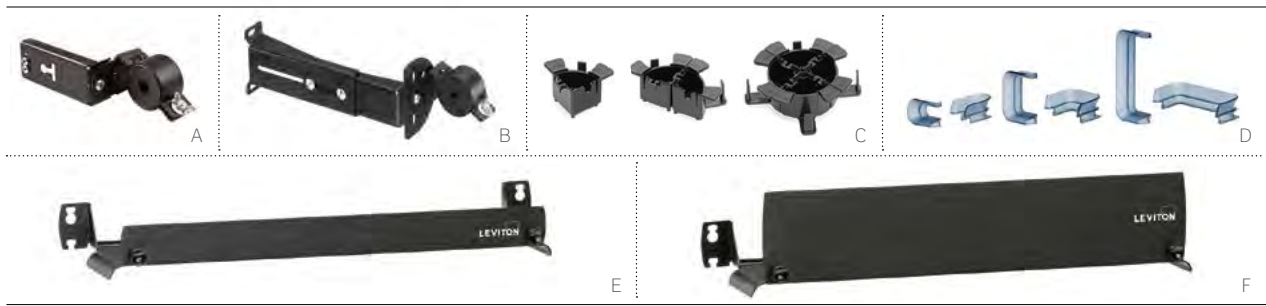

## OPT-X SYSTEM ACCESSORIES

- Cable clamp kits minimize excessive pulling, bending, and crushing
- Supports easy cable identification and decreases the need for tie-wraps inside the enclosure
- Fiber Cable Management Rings secure fiber slack
- Patch Cord Management Trays help route and organize cables, mount directly to the front of the enclosures, and do not require additional rack space

AVAILABLE FOR

ACCESSORIES		AVAILABLE FOR		
DESCRIPTION	PART NO.	OPT-X ULTRA®	OPT-X 1000i	OPT-X 500i
<b>[A]</b> Universal Opt-X Clamp Kit, Single Cable Grommet (for enclosure mounting)	5RCMP-KIT	X	X	X
Universal Opt-X Clamp Kit, Multiple Cable Grommet (for enclosure mounting)	5RCMP-KT2	X	X	X
<b>[B]</b> Universal Clamp Kit, Single and Multiple Cable Grommet (for rack mounting)	5RCMR-KIT	X	X	X
1RU 23" Rack and Cabinet Mounting Bracket <sup>^</sup>	5R1RU-023	X	X	
Replacement Door <sup>^</sup>	5D000-*UN	X		
Replacement Door with Lock <sup>^</sup>	5D000-*UL	X		
Replacement Covers <sup>^</sup>	5C000-RPL	X		
Covers, metal <sup>^</sup>	5CMTL-RPL	X		
<b>[C]</b> Fiber Cable Management ¼" Ring Kit (bag of four ¼" rings)	5R100-14R	X	X	X
<b>[D]</b> Opt-X Ultra Patch Cord Bend Radius Bracket (bag of two) <sup>^</sup>	5PCBR-*BT	X		
Lock and Key for Rack-Mount Enclosure	5L000-KAL		X	
<b>[E]</b> Patch Cord Management Tray, 1RU (for use with 1RU enclosure), 4" depth	5R1UL-CMT			X
<b>[F]</b> Patch Cord Management Tray, 2RU (for use with 2 & 3RU enclosure), 4" depth	5R2UL-CMT			X
Grounding Kit	DPGRD-KIT	X	X	X

<sup>^</sup> = Minimum order quantity and lead times may apply.

\* = Rack Units: 1RU (1), 2RU (2), 4RU (4)

## SPOTLIGHT

### Cable Clamp Kits

**Cable clamp kits** minimize excessive pulling, bending, and crushing forces on cable. The Opt-X Enclosure-Mount Universal Clamp Kit makes it easy to identify cables, and decreases the need for tie-wraps inside the enclosure. The kit also creates a transition point from jacketed cable to buffered fiber or subunits. The Opt-X Rack-Mount Universal Clamp Kit is ideal for vertical strain relief and strain relief at the top or bottom of a rack/cabinet. Use it for installations with minimal vertical cable pathways and little space for an enclosure-mount cable clamp kit.

Rack-Mount Universal Clamp Kit Installed

Enclosure-Mount Universal Clamp Kit Installed

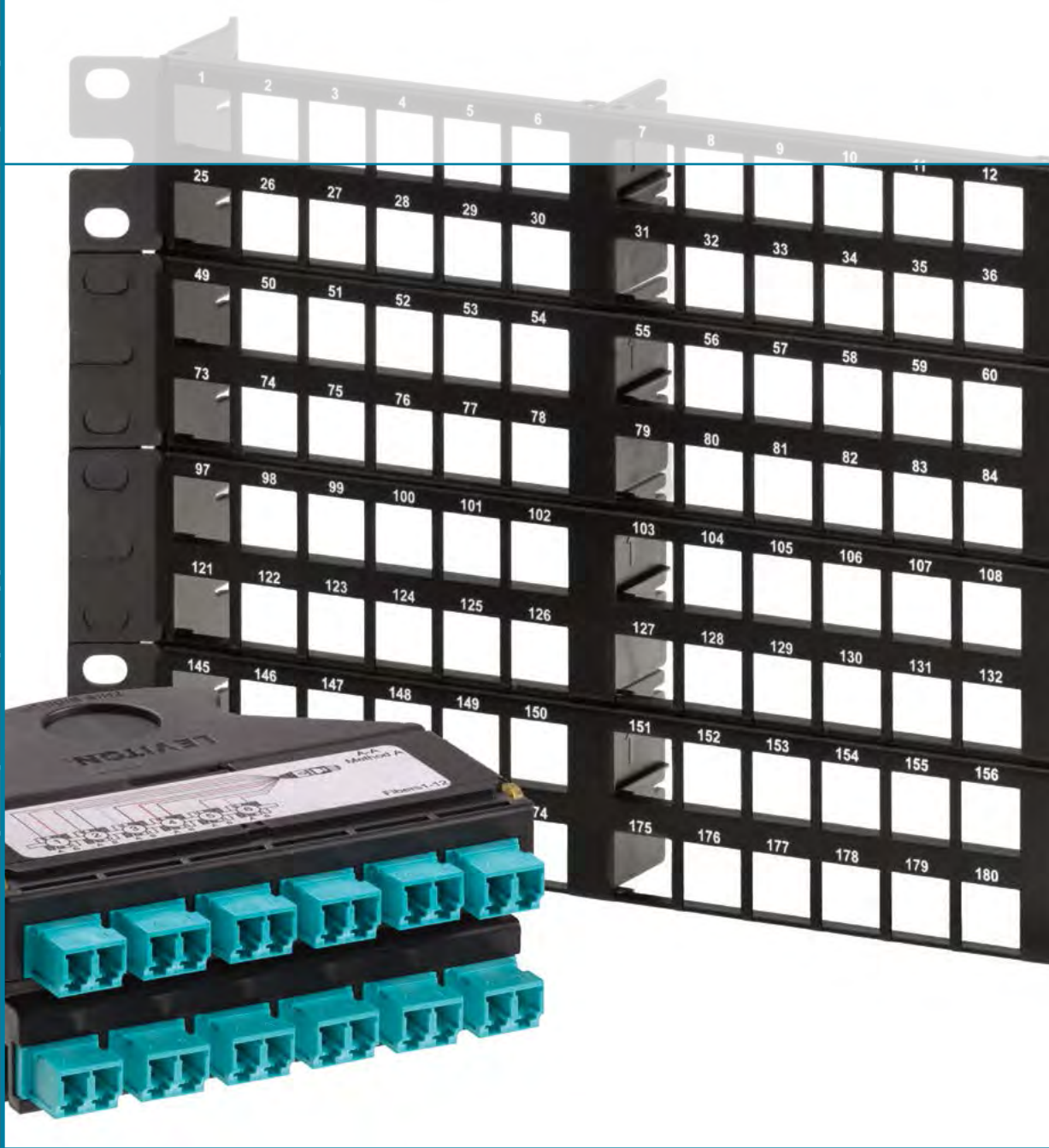
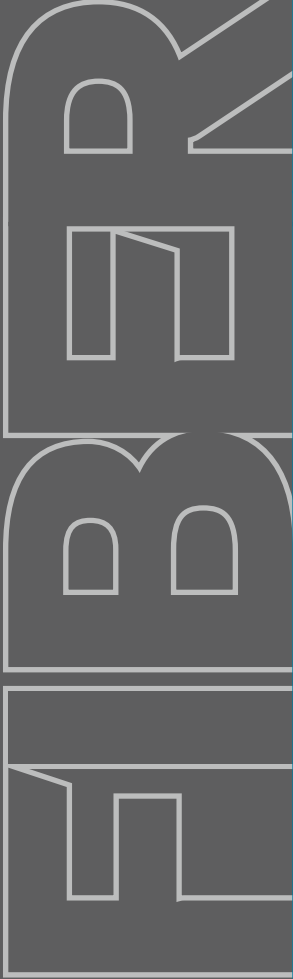

## e2XHD patching system

The e2XHD Copper and Fiber Patching System is an easy-to-connect, high-density solution for enterprise and data center applications, where fast deployment and simple maintenance are critical. The system includes 1RU and 4RU high-density panels, copper and fiber snap-in cassettes, and accessories for additional cable protection and management. The e2XHD cassettes quickly snap in and pull out of the panels, making installation, moves, adds, and changes easier than ever. For copper cassettes, see page A18.

### FEATURED PRODUCTS

- Panels **B29**
- Cassettes **B30**



## e2XHD HIGH-DENSITY PATCH PANELS

High-density panels allow patching for up to 48 duplex fiber channels in a 1RU panel or 192 channels in a 4RU panel.

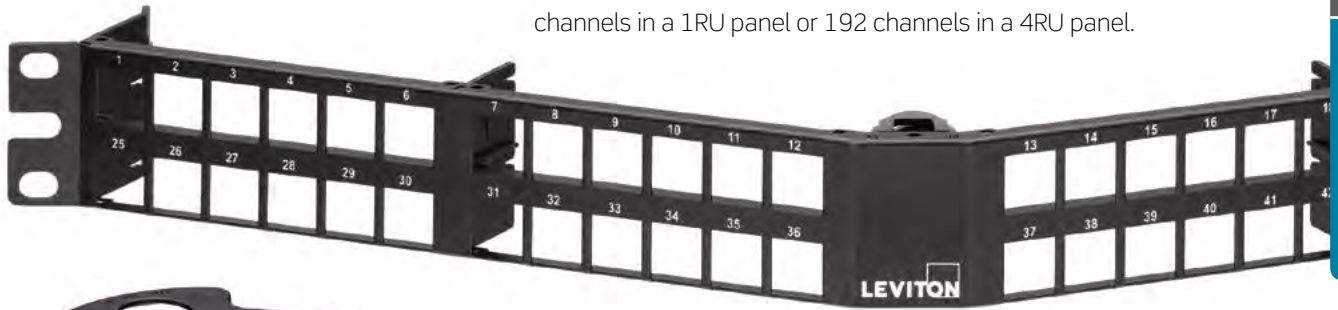

e2XHD 12-Fiber QuickPort® LC Cassette, OM3/OM4 - Aqua



e2XHD MTP-MTP Pass-Through Cassette



e2XHD MTP-MTP Fiber Cassette, Core

## e2XHD FIBER CASSETTES

Fiber MTP® Cassettes provide a simple migration path to 40G or 100G networks. The cassettes are pre-terminated and available in 12 or 24 fibers, OM3, OM4, or single mode.

The e2XHD Fiber Cassette features an MTP adapter that swivels to three positions for easier cable routing. Used in conjunction with the patching system's rear cable manager and cable management rings, the adapter delivers an ideal solution for eliminating cable tension and ensuring proper bend radius.



## The Industry's Best Service & Support

### DENNIS MANES, RCDD

Fiber and Data Center Principal Applications Engineer  
Manager, Technical Support

Dennis has a hand in a little of everything at Leviton, and our satisfied customers are thankful for it. He helps develop innovative new products while ensuring they meet industry standards and user requirements. He designs data center layouts and cable pathways, customized to each installation. He provides installation support for operations nationwide and abroad. On top of all that, he leads Leviton's team of technical support representatives, ready to assist customers with product, installation, and design support. With all his expertise and tireless effort, sometimes we wonder if Dennis has a secret twin or clone army.



# E2XHD PATCHING SYSTEM | Panels, Cable Managers, Covers & Tools

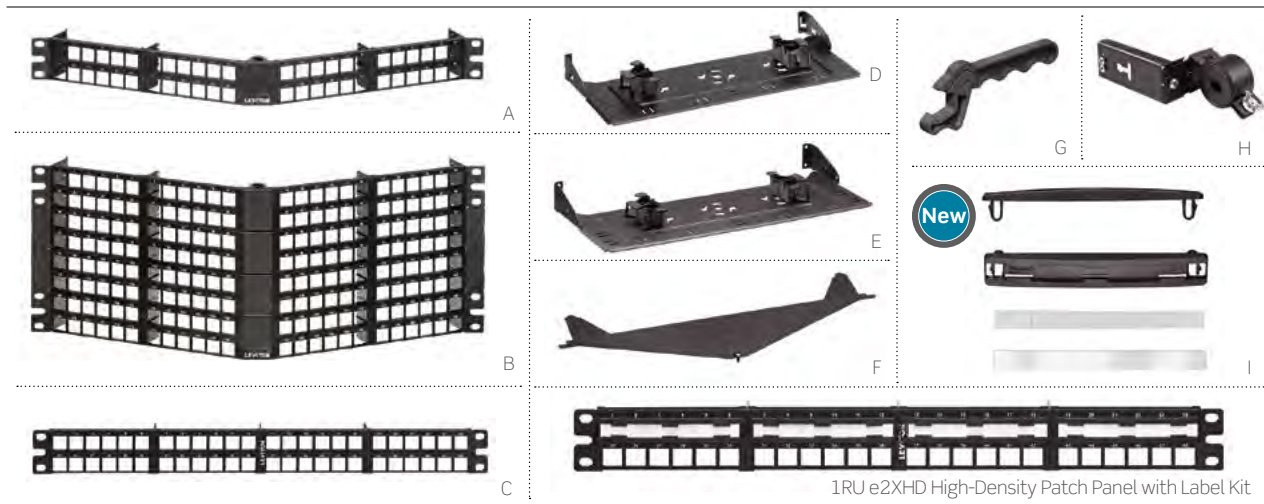

1RU e2XHD High-Density Patch Panel with Label Kit

## HIGH-DENSITY PANELS

- 1RU panels hold up to 8 single-height fiber cassettes (48 fiber channels)
- 4RU panels hold up to 32 single-height fiber cassettes (192 fiber channels)
- Alignment tabs on panels ensure upright insertion of cassettes
- Mount on standard 19" racks or cabinets

## ANGLED PANEL COVER

- Uses no additional rack space
- Minimizes dust and debris behind panels
- Attaches directly to e2XHD Angled Panel
- Can be retrofitted after panel is installed
- Can be used for top and bottom of panels

## REAR CABLE MANAGERS

- Support both fiber and copper cables
- Cable management rings included to help manage and route incoming fiber cables
- Built-in VELCRO® Brand tie downs secure cables
- Optional Clamp Kits available to provide cable strain relief for incoming cables
- Flat Panel Manager mounts to rack or cabinet; screws included
- Angled Panel Manager attaches directly to panels; screws included

## e2XHD PATCHING SYSTEM VIDEO



Watch the training video at [leviton.com/videos](http://leviton.com/videos):  
“e2XHD Patching System for Data Center Networks.”

e2XHD PATCHING SYSTEM PANELS, CABLE MANAGERS, COVERS & TOOLS		
DESCRIPTION		PART NO.
[A]	e2XHD 1RU High-Density Angled Panel	E2X1A-D48
[B]	e2XHD 4RU High-Density Angled Panel	E2X4A-192
[C]	e2XHD 1RU High-Density Flat Panel	E2X1F-D48
	e2XHD 4RU High-Density Flat Panel	E2X4F-192
[D]	e2XHD Rear Cable Manager for Angled Panel, with cable management rings	E2XHD-CMB
[E]	e2XHD Rear Cable Manager for Flat Panel, with cable management rings	E2X1F-CMB
[F]	e2XHD Angled Panel Cover	E2XHD-COV
[G]	QuickPort® Connector Removal Tool	E2XHD-JRT
[H]	Universal Opt-X® Clamp Kit, Single Cable Grommet (mounts to Rear Cable Manager)	5RCMP-KIT
	Universal Opt-X Clamp Kit, Multiple Cable Grommet (mounts to Rear Cable Manager)	5RCMP-KT2
	Universal Clamp Kit, Single and Multiple Cable Grommet (for rack mounting)	5RCMR-KIT
[I]	Label Kit for e2XHD Panels (Qty 4)	E2XHD-LBL



e2XHD patching system  
**FIBER**

## FIBER CASSETTES

- Used exclusively with e2XHD panels
- Available in MTP-MTP or MTP-LC
- Available in 12- or 24-fiber, OM3, OM4, OS2
- Allow for a simple migration path to 40GbE and 100GbE networks with MTP cassettes
- MTP adapter swivel allows for easy cable routing and proper bend radius
- QuickPort® MTP-LC Cassette uses QuickPort modular fiber adapters, can be removed with QuickPort Connector Removal Tool
- All cassettes use either 24-fiber or 12-fiber low-loss MTP connectors
- Blank cassettes reserve capacity for future cassettes, easily snap into rear of panel to block unused cassette openings



e2XHD PATCHING SYSTEM CASSETTES	
DESCRIPTION	PART NO.
<b>[A]</b> e2XHD 24-fiber MTP-LC Fiber Cassette, Core	(see options below)
<b>[B]</b> e2XHD 12-fiber MTP-LC Fiber Cassette, Core (OM4 violet shown)	(see options below)
<b>[C]</b> e2XHD MTP-MTP Fiber Cassette, Core	(see options below)
<b>[D]</b> e2XHD 24-fiber MTP-LC Fiber Cassette, Edge (1x24 Fiber MTP)	(see options below)
<b>[E]</b> e2XHD 24-fiber MTP-MTP Fiber Cassette, Edge (2x24 Fiber MTP)	(see options below)
<b>[F]</b> e2XHD 24-fiber MTP-MTP Fiber Cassette, Edge (1x24 Fiber MTP)	(see options below)
<b>[G]</b> e2XHD 12-fiber QuickPort LC Cassette, OM3/OM4 - aqua	E2XLC-AQU
e2XHD 12-fiber QuickPort LC Cassette, OS2 - blue	E2XLC-BLU
<b>[H]</b> e2XHD MTP-MTP Pass-Through Cassette, four key-up/key-down adapters	E2XHD-4MP
e2XHD MTP-MTP Pass-Through Cassette, four key-up/key-up adapters	E2XHD-4MB
<b>[I]</b> e2XHD Cassette Blank	E2XHD-BLK

Make to order!		e2XHD MTP FIBER CASSETTE OPTIONS				
FIBER TYPE	FIBER COUNT	CONNECTOR TYPE	MTP FIBER COUNT	FOOTPRINT	COLOR	POLARITY
• OM3	• 8	• LC	• 12F MTP	• 12 Fiber (single cassette height)	• MM aqua adapter	• Method A
• OM4 (aqua)	• 12	• 8F MTP (female)	• 24F MTP	• 24 Fiber (double cassette height)	• SM blue adapter	• Method B, Core, black
• OM4 (violet)	• 24				• Black (MTP only)	• Method B, Edge, white
• OS2					• MM Violet Adapter (OM4 only)	• Method C

For assistance customizing your cassettes, please visit [leviton.com/configurator](http://leviton.com/configurator) or call Tech Support at 800.824.3005.



## FEATURED PRODUCTS

Enclosures **B32**

Adapter Plates **B35**

Splice Trays & Holders **B37**

Splice Sleeves & Enclosure Accessories **B38**

## LightSpace<sup>®</sup> enclosure system

Leviton offers a wide range of enclosures designed to protect, manage, and organize fiber splices across various indoor and outdoor environments. Specifically designed to meet the requirements of service providers large and small, LightSpace enclosures are ideal for central-office, outside-plant, and fiber-to-the-premises applications.



## KEY FEATURES

- Large cable management rings for enhanced jumper routing
- Front cable management saddles
- Side entry for backbone cable
- Constructed of high-strength aluminum, powder-coated central-office white
- Mounts on standard 19" and 23" racks and cabinets
- Utilizes LightSpace adapter plates (see pages B35-B36)



## RECOMMENDED APPLICATIONS:

Central Office or Head End, CLEC  
19" and 23" Racks and Cabinets

## DP SERIES OPTICAL DISTRIBUTION ENCLOSURES

- Removable front door
- Rear door with key lock option
- Upper and lower patch cord bend radius brackets

## DPS & DPC SERIES OPTICAL SPLICE ENCLOSURES

- Front accessibility to splice trays
- Removable front door with key lock option
- Rear door with key lock option
- Connector identification label

For assistance configuring your enclosures, please call Tech Support at 800.824.3005 or visit [leviton.com/configurator](http://leviton.com/configurator).

### LIGHTSPACE DP OPTICAL DISTRIBUTION ENCLOSURES, STANDARD PART NUMBERS

DESCRIPTION	MAXIMUM CAPACITY			PART NO.
	FIBERS (USING LC)	ADAPTER PLATES	AND SPLICE TRAYS*	
DP-525, 3RU, empty <sup>^</sup>	144	6	N/A	DP03U-STD
<b>[A]</b> DP-700, 4RU, empty <sup>^</sup>	288	12	N/A	DP04U-STD
DP-105, 6RU, empty <sup>°</sup>	288	12	N/A	DP06U-STD

### LIGHTSPACE DPS OPTICAL SPLICE ENCLOSURES, STANDARD PART NUMBERS

DPS-525, 3RU, empty	N/A	N/A	4	DPS3U-STD
<b>[B]</b> DPS-700, 4RU, empty	N/A	N/A	6	DPS4U-STD
DPS-105, 6RU, empty	N/A	N/A	12	DPS6U-STD

### LIGHTSPACE DPC OPTICAL DISTRIBUTION & SPLICE ENCLOSURES, STANDARD PART NUMBERS

DPC-525, 6RU, empty <sup>^</sup>	144	6	4	DPC6U-033
<b>[C]</b> DPC-700, 8RU, empty <sup>^</sup>	288	12	6	DPC8U-STD
DPC-105, 12RU, empty <sup>°</sup>	288	12	12	DPC12-066

\* = Maximum splice tray capacity is limited by height of selected splice tray. See page X13 for splice tray dimension and selection guide.

<sup>^</sup> = Accepts LightSpace (LGX® footprint) 6- or 8-pack adapter plates.

<sup>°</sup> = Accepts LightSpace 12-pack adapter plates.



**LIGHTSPACE CPC SERIES CUSTOMER PREMISE ENCLOSURES**

- Wide-swing radius doors provide full access during installation and maintenance
- Double doors with slam latches provide separation between service provider and customer
- Top or bottom cable entry
- Stackable, allowing for additional capacity
- Constructed of high-strength aluminum, powder-coated central-office white
- Accepts all Leviton splice trays
- Utilizes LightSpace adapter plates (see pages B35-B36)

**RECOMMENDED APPLICATIONS:**

Central Office or Head End, CLEC  
Wall Mount



**LIGHTSPACE CPS SERIES CUSTOMER PREMISE SPLICE ENCLOSURES**

- Single-fixed left-hinged door with wide-swing radius design for easy access
- Top or bottom cable entry
- Stackable, allowing for additional capacity
- Padlock provision
- Constructed of high-strength aluminum, powder-coated central-office white
- Accepts all Leviton splice trays

**RECOMMENDED APPLICATIONS:**

Central Office or Head End, CLEC  
Enterprise

**CPC CUSTOMER PREMISE ENCLOSURES, STANDARD PART NUMBERS**

DESCRIPTION	MAXIMUM CAPACITY			PART NO.
	FIBERS (USING LC)	ADAPTER PLATES	AND SPLICE TRAYS*	
<b>[A]</b> CPC-12, empty	48	2	4	CPC12-STD
<b>[B]</b> CPC-24, empty	96	4	4	CPC24-STD
CPC-48, empty	192	8	6	CPC48-STD

**CPS CUSTOMER PREMISE SPLICE ENCLOSURES, STANDARD PART NUMBERS**

CPS-12, empty	N/A	N/A	4	CPS12-STD
CPS-24, empty	N/A	N/A	4	CPS24-STD
<b>[C]</b> CPS-48, empty	N/A	N/A	6	CPS48-STD

\* = Maximum splice tray capacity is limited by height of selected splice tray. See page X13 for splice tray dimension and selection guide.

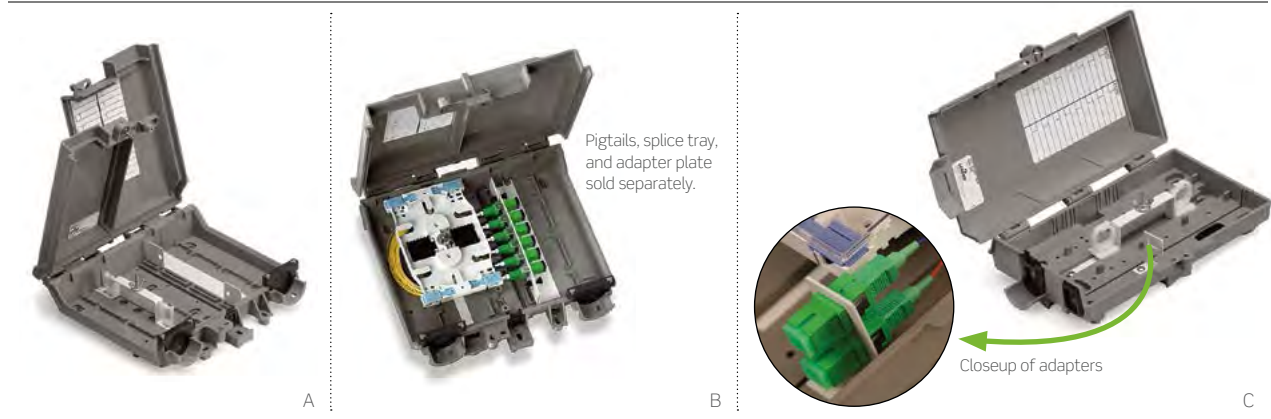

Pigtails, splice tray, and adapter plate sold separately.

Closeup of adapters

## LIGHTSPACE NETWORK INTERFACE DEVICES (NIDS)

- 3500 model has double upper-hinge doors
- 502H model has a single upper-hinge door
- 530 model has a single left-hinge door
- 502H and 3500 models have padlock provision for added security
- All enclosures are custom configurable
- Unique hinging mechanism holds the door open for easy installation and servicing
- Utilizes LightSpace adapter plates (see pages B35-B36)
- Splice tray option available



### RECOMMENDED APPLICATIONS:

- Demarcation Point
- Telecommunications Room
- Equipment Room
- Wall Mount

## NETWORK INTERFACE DEVICES (NID), STANDARD PART NUMBERS

DESCRIPTION	MAXIMUM CAPACITY					PART NO.
	FIBERS (USING LC)	ADAPTER PLATES	AND	SPLICE TRAYS*	OR	
<b>[A]</b> NID 3500, double door, empty	12	1		1		N3500-STD
<b>[B]</b> NID 502H, single door, empty	12	1		1		N502H-STD
<b>[C]</b> NID 530, single door, left hinge, empty	8	0**		1		N5300-STD

\*Accepts 12-fiber Mini-Molded Splice Tray T5PLS-12F (page B25).

\*\*Accepts 2 individual adapters (LC Duplex/SC Simplex).

## Make to order! CUSTOM CONFIGURED NID OPTIONS

NID STYLE	ADAPTER PLATE SELECTION	FIBER TYPE	ADAPTER TYPE & PIGTAIL SELECTION
<ul style="list-style-type: none"> <li>• 502H</li> <li>• 3500</li> <li>• 530</li> </ul>	<ul style="list-style-type: none"> <li>• 6 fibers (SC, ST), (FN502, FN350 only)</li> <li>• 2 fibers (SC, LC), (FN530 only)</li> <li>• 8 fibers (SC, ST), (FN502, FN350 only)</li> <li>• 4 fibers (SC, LC), (FN530 only)</li> <li>• 12 fibers (SC, LC), (FN502, FN350 only)</li> <li>• 8 fibers (LC) (FN530 only)</li> </ul>	<ul style="list-style-type: none"> <li>• OM1</li> <li>• OM2</li> <li>• OM3</li> <li>• OM4 (aqua)</li> <li>• OM4 (violet)</li> <li>• OS2</li> </ul>	<ul style="list-style-type: none"> <li>• LC</li> <li>• LC + pigtail</li> <li>• SC</li> <li>• SC/APC</li> <li>• SC + pigtail</li> <li>• SC/APC + pigtail</li> <li>• ST</li> <li>• ST + pigtail</li> </ul>

For assistance customizing your NIDs, please visit [leviton.com/configurator](http://leviton.com/configurator) or call Tech Support at 800.824.3005.

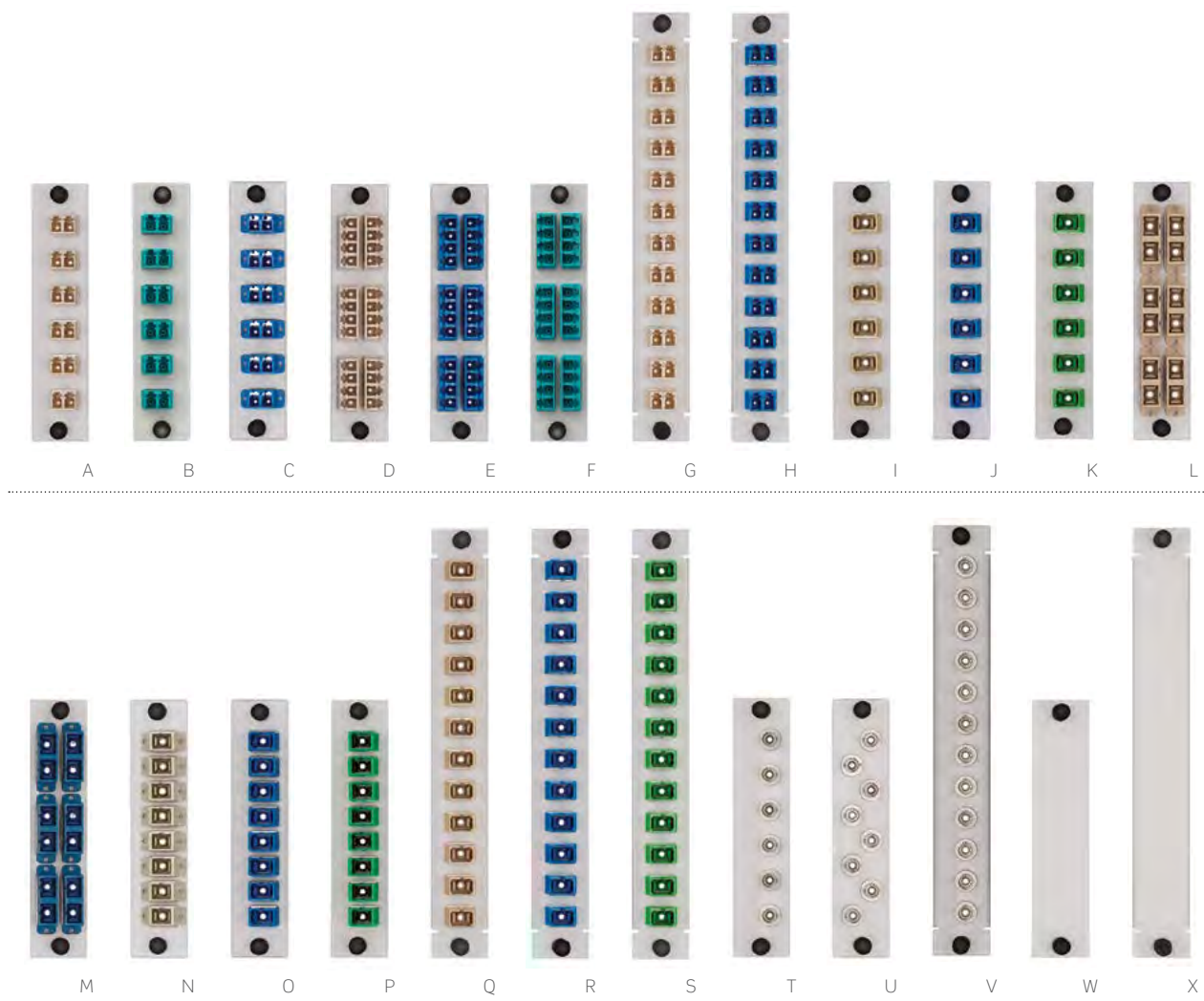

## LIGHTSPACE ADAPTER PLATES

- Industry-standard style (LGX® footprint) adapter plates fit in all LightSpace wall-mount and rack-mount enclosures, and NIDs
- Captive push/pull fasteners allow for quick, tool-free installation and removal
- Available in 6-, 8-, and 12-packs
- All 6- and 8-packs also available in black
- Available in LC, SC, ST, and MTP®

## LIGHTSPACE RACK-MOUNT ENCLOSURE FIBER DENSITY CHART

OPTICAL DISTRIBUTION ENCLOSURES		
DP/DPC 525	DP/DPC 700	DP/DPC 105
Holds up to six 6-pack or 8-pack plates 6-Pack = up to 36 fibers 8-Pack = up to 48 fibers Duplex 6-Pack = up to 72 fibers Quad 6-Pack = up to 144 fibers	Holds up to twelve 6-pack or 8-pack plates 6-Pack = up to 72 fibers 8-Pack = up to 96 fibers Duplex 6-Pack = up to 144 fibers Quad 6-Pack = up to 288 fibers	Holds up to twelve 12-pack plates 12-Pack = up to 288 fibers



# LIGHTSPACE® ENCLOSURE SYSTEM | Adapter Plates

LIGHTSPACE FIBER ADAPTER PLATES	
DESCRIPTION	PART NO.
<b>[A]</b> 6-Pack Duplex LC MM (12-fiber), beige, phosphor bronze sleeve	APLW6-LDM
<b>[B]</b> 6-Pack Duplex LC Laser-Optimized MM (12-fiber), aqua, zirconia ceramic sleeve ^	APLW6-LDL
<b>[C]</b> 6-Pack Duplex LC SM (12-fiber), blue, zirconia ceramic sleeve	APLW6-LDS
<b>[D]</b> 6-Pack Quad LC MM (24-fiber), beige, phosphor bronze sleeve ^	APLW6-LQM
<b>[E]</b> 6-Pack Quad LC SM (24-fiber), blue, zirconia ceramic sleeve ^	APLW6-LQS
<b>[F]</b> 6-Pack Quad LC Laser-Optimized MM (24-fiber), aqua, zirconia ceramic sleeve ^	APLW6-LQL
<b>[G]</b> 12-Pack (White) Duplex LC MM (24-fiber), beige, phosphor bronze sleeve (DP or DPC 105 Enclosure only) ^	APL12-LDM
<b>[H]</b> 12-Pack (White) Duplex LC SM (24-fiber), blue, zirconia ceramic sleeve (DP or DPC 105 Enclosure only) ^	APL12-LDS
<b>[I]</b> 6-Pack SC MM (6-fiber), beige, phosphor bronze sleeve	APLW6-SCM
<b>[J]</b> 6-Pack SC SM (6-fiber), blue, zirconia ceramic sleeve	APLW6-SCS
<b>[K]</b> 6-Pack SC/APC SM (6-fiber), green, zirconia ceramic sleeve	APLW6-SCA
<b>[L]</b> 6-Pack Duplex SC MM (12-fiber), beige, phosphor bronze sleeve	APLW6-SDM
<b>[M]</b> 6-Pack Duplex SC SM (12-fiber), blue, zirconia ceramic sleeve	APLW6-SDS
6-Pack Duplex SC/APC SM (12-fiber), green, zirconia ceramic sleeve ^	APLW6-SDA
<b>[N]</b> 8-Pack (White) SC MM (8-fiber), beige, phosphor bronze sleeve	APLW8-SCM
<b>[O]</b> 8-Pack (White) SC SM (8-fiber), blue, zirconia ceramic sleeve	APLW8-SCS
<b>[P]</b> 8-Pack (White) SC/APC SM (8-fiber), green, zirconia ceramic sleeve	APLW8-SCA
<b>[Q]</b> 12-Pack (White) SC MM (12-fiber), beige, phosphor bronze sleeve (DP or DPC 105 Enclosure only) ^	APL12-SCM
<b>[R]</b> 12-Pack (White) SC SM (12-fiber), blue, zirconia ceramic sleeve (DP or DPC 105 Enclosure only) ^	APL12-SCS
<b>[S]</b> 12-Pack (White) SC/APC SM (12-fiber), green, zirconia ceramic sleeve (DP or DPC 105 Enclosure only) ^	APL12-SCA
6-Pack ST MM (6-fiber), phosphor bronze sleeve	APLW6-STM
<b>[T]</b> 6-Pack ST SM (6-fiber), zirconia ceramic sleeve	APLW6-STS
<b>[U]</b> 8-Pack ST MM (8-fiber), phosphor bronze sleeve	APLW8-STM
8-Pack ST SM (8-fiber), zirconia ceramic sleeve	APLW8-STS
12-pack (White) ST MM (12-fiber), beige, phosphor bronze sleeve (DP or DPC 105 Enclosure only) ^	APL12-STM
<b>[V]</b> 12-Pack (White) ST SM (12-fiber), blue, zirconia ceramic sleeve (DP or DPC 105 Enclosure only) ^	APL12-STS
6-Pack MTP® MM (72-fiber), key up/key down	APLW6-6MP
<b>[W]</b> Blank Plate, metal	APLW6-BLK
<b>[X]</b> 12-Pack (White) blank (DP or DPC 105 Enclosure only) ^	APL12-BLK

^ = Minimum order quantity and lead times may apply.

Additional adapter plate configurations available. Please contact Tech Support at 800.824.3005 for more information.

## LIGHTSPACE WALL-MOUNT ENCLOSURE FIBER DENSITY CHART

CUSTOMER PREMISE ENCLOSURES		
CPC-12	CPC-24	CPC-48
Holds up to two 6-pack or 8-pack plates 6-Pack = up to 12 fibers 8-Pack = up to 16 fibers Duplex 6-Pack = up to 24 fibers Quad 6-Pack = up to 48 fibers	Holds up to four 6-pack or 8-pack plates 6-Pack = up to 24 fibers 8-Pack = up to 32 fibers Duplex 6-Pack = up to 48 fibers Quad 6-Pack = up to 96 fibers	Holds up to eight 6-pack or 8-pack plates 6-Pack = up to 48 fibers 8-Pack = up to 64 fibers Duplex 6-Pack = up to 96 fibers Quad 6-Pack = up to 192 fibers

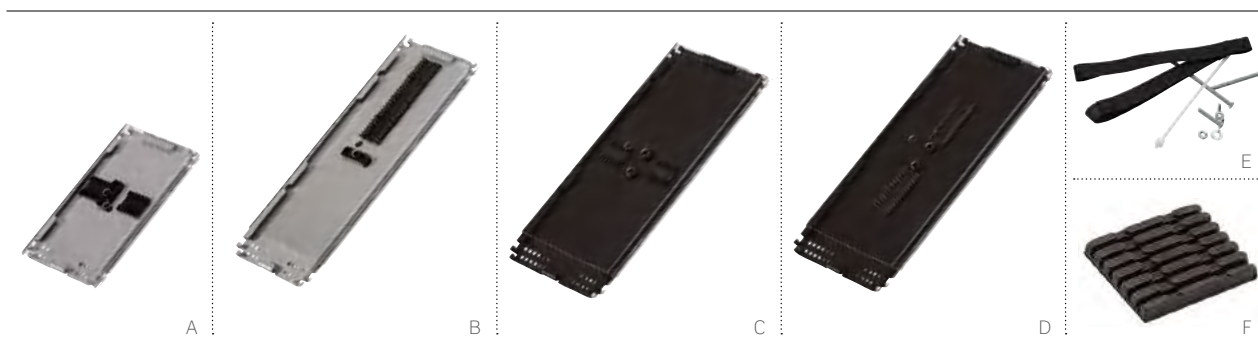

## METAL SPLICE TRAYS

- Available in 4" and 5" sizes with 12- or 24-fiber capacity
- Heat-shrink, heat-shrink foam, and bare-fusion styles available
- Mounting holes with space blocks prevent fiber damage
- Compatible with Opt-X® and LightSpace enclosures
- Splice tray selector is available online at [leviton.com/configurator](http://leviton.com/configurator)
- Heat-shrink fusion splice sleeves sold separately

## SPLICE HOLDERS

- 6- and 12-fiber designs in foam and solid plastic options
- Mini, micro, and mechanical options available
- Styles accommodate the entire range of Leviton fusion splice sleeves

### METAL SPLICE TRAYS

DESCRIPTION	HEAT SHRINK (PLASTIC)	HEAT SHRINK (FOAM)	BARE FUSION
<b>[A]</b> 12-fiber Mini, 4" W x 7" L x 0.35" H	T47HS-P06	—	T47BF-P06 ^
12-fiber Mini, with standoff 4" W x 7" L x 0.57" H	5T000-00T	—	—
12-fiber Standard, 4" W x 11.75" L x 0.35" H	T4LHS-P06	T4LHS-F06 ^	T4LBF-P06
<b>[B]</b> 24-fiber High Density, 4" W x 11.75" L x 0.35" H	T4LHS-P12	T4LHS-F12 ^	T4LBF-P12
<b>[C]</b> 12-fiber Standard, 5" W x 11.75" L x 0.35" H	T5LHS-P06	T5LHS-F06 ^	T5LBF-P06
<b>[D]</b> 24-fiber High Density, 5" W x 11.75" L x 0.35" H	T5LHS-B12	T5LHS-F12	T5LBF-P12 ^

### RIBBON-STYLE SPLICE TRAYS

DESCRIPTION	PART NO.
72-fiber Ribbon Style, quartz, 6" W x 10" L x 0.35" H	T6XRB-40Q

### SPLICE TRAY MOUNTING HARDWARE

<b>[E]</b> Splice Tray Mounting-Hardware Kit	SPLMT-HKT
--	-----------

### SPLICE HOLDERS

Splice Holder, heat shrink (black plastic), 6-fiber capacity	FSHHS-P06
Splice Holder, heat shrink (black plastic), 8-fiber capacity	FSHHS-P08
<b>[F]</b> Splice Holder, heat shrink (black foam), 6-fiber capacity	FSHSL-F06
Splice Holder, mini sleeves (black foam), 6-fiber capacity	FSHMI-F06
Splice Holder, micro sleeves (black foam), 6-fiber capacity	FSHMR-F06
Splice Holder, bare fusion, 12-fiber capacity	FSHBF-P12
Splice Holder, heat shrink (LGX® footprint), 6-fiber capacity	FSHAT-F06
Splice Holder, ribbon, 6 position, 72-fiber capacity	FSHRB-F06

^ = Minimum order quantity and lead times may apply.

Note: Splice tray mounting hardware sold separately except as noted. Additional configurations available including mechanical splice. Contact inside sales at 800.722.2082 for more information.

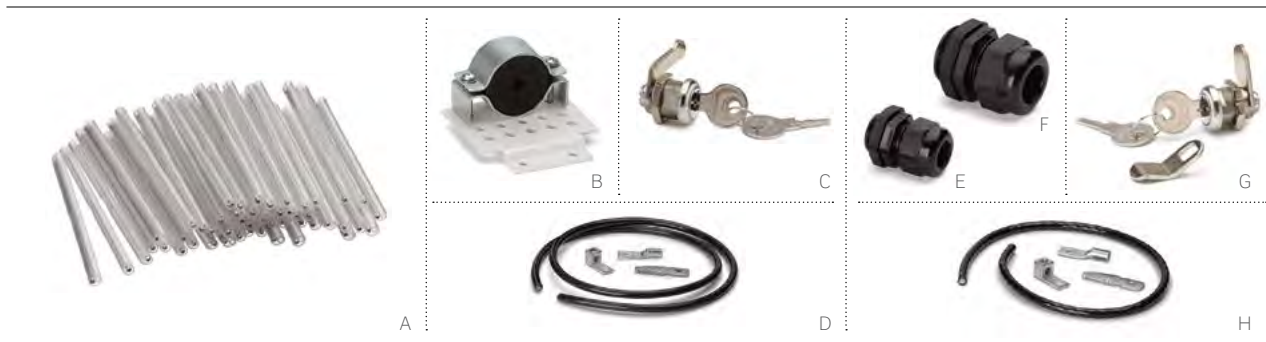

## FUSION SPLICE SLEEVES

- Standard 40 mm and 60 mm sizes, plus mini and micro sleeves for smaller trays and fibers
- Precise lengths free of all burrs and sharp edges
- Clear outer tube for viewing fiber color

## LIGHTSPACE ENCLOSURE ACCESSORIES

Select cable clamp kits, key locks, strain-relief options, or grounding solutions.

FUSION SPLICE SLEEVES					
DESCRIPTION	STANDARD 50/PACK	SLIM 100/PACK	MINI 100/PACK	MICRO 100/PACK	REBON 25/PACK
Fusion Splice Sleeve, 60 mm	<b>[A]</b> FSSSD-060	FSSSL-060	—	—	—
Fusion Splice Sleeve, 40 mm	FSSSD-040	FSSSL-040	FSSMI-040	FSSMR-040	—
Fusion Splice Sleeve, 25 mm	—	—	FSSMI-025	FSSMR-025	—
Fusion Splice Sleeve, quartz, 40 mm	—	—	—	—	FSSRB-Q40

LIGHTSPACE DP, DPS & DPC SERIES ACCESSORIES	
DESCRIPTION	PART NO.
<b>[B]</b> Cable Clamp Kit (.25" - 1.25" diameter)	DPCMP-UNV
<b>[C]</b> Key Lock Kit	DPLOK-KIT
<b>[D]</b> Grounding Kit	DPGRD-KIT

LIGHTSPACE CPC & CPS SERIES ACCESSORIES	
DESCRIPTION	PART NO.
<b>[E]</b> Cable Clamp Kit (.25" - .50" diameter cable), use with CPC/CPS 12/24/48	CPCSR-001
<b>[F]</b> Cable Clamp Kit (.50" - .75" diameter cable), use with CPC/CPS 24/48	CPCSR-002
<b>[G]</b> Key Lock Kit	CPLOK-KIT
<b>[H]</b> Grounding Kit, single cable	CPGRD-KIT

SPLICE TRAY	RECOMMENDED SPLICE SLEEVE
T47HS-P06	FSSSD-040
T47BF-P06	FSSSD-040
5T000-00T	FSSSD-040
T4LHS-P06	FSSSD-060
T4LHS-F06	FSSSD-060
T4LBF-P06	FSSSD-060

SPLICE TRAY	RECOMMENDED SPLICE SLEEVE
T4LHS-P12	FSSSD-040
T4LHS-F12	FSSSD-040
T4LBF-P12	FSSSD-040
T5LHS-P06	FSSSD-060
T5LHS-F06	FSSSD-060

SPLICE TRAY	RECOMMENDED SPLICE SLEEVE
T5LBF-P06	FSSSD-060
T5LHS-B12	FSSSD-040
T5LHS-F12	FSSSD-040
T5LBF-P12	FSSSD-040
T6XRB-40Q	FSSRB-Q40



## flush-mount enclosures & panels

Leviton high-density Flush-Mount Enclosures and Panels are ideal for data center server, zone, or MDA cabinet applications where space is crucial. These enclosures utilize MTP® connections on the back with choice of fiber connectors on the front, or can be pre-assembled with harnesses. Panels can accommodate up to 576 multimode or single-mode fibers, depending on connector style, and mount on standard 19-inch racks and cabinets.

### FEATURED PRODUCTS

Flush-Mount Enclosures & Panels **B40**



1RU Enclosure, 48-fiber OM3, MTP®-LC

1RU Panel, 72-fiber OM3, LC

1RU Panel, 72-fiber, OS2, MU

## HIGH-DENSITY FLUSH-MOUNT ENCLOSURES & PANELS SERIES

- Staggered, ergonomic design allows easy access to connectors
- Incorporates logical port management (LPM) using custom silk-screening (modular, numeric, and hexadecimal) for easy port identification
- Constructed of 16-gauge steel, powder-coated black
- Panel mounts on standard 19" racks and cabinets
- Accepts 1RU Patch Cord Management Tray (5R1UL-CMT)
- Larger enclosures (up to 10RU ) are available, contact Inside Sales to order



### RECOMMENDED APPLICATIONS:

- Data Center Server, Zone, or MDA
- Equipment Room
- Telecommunications Room
- 19" Racks and Cabinets

## FLUSH-MOUNT ENCLOSURE & PANEL DENSITY, MAXIMUM FIBER COUNT

SIZE/TYPE	LC	SC	ST	MU
1RU Panel/Enclosure	96	72	72	72

## Make to order! FLUSH-MOUNT ENCLOSURE & PANEL (1RU ONLY) OPTIONS

FIBER TYPE	FIBER COUNT	CONNECTOR TYPE	MTP FIBER COUNT	FOOTPRINT	COLOR	POLARITY
• OM1	• 24	• LC	• 12	• 1RU Rack Mount	• Black (standard)	• A-A
• OM2	• 36	• LC w/shutters			• Beige	• A-B
• OM3	• 48	• SC				
• OM4 (aqua)	• 72	• ST				
• OM4 (violet)	• 96	• MU				
• OS2	• 144					

For assistance customizing your enclosures and panels, please visit [leviton.com/configurator](http://leviton.com/configurator) or call Tech Support at 800.824.3005.

## SPOTLIGHT Patch Cord Management Tray



The Opt-X® 500i Patch Cord Management Tray provides convenient routing and protection using the same rack-unit space as the enclosure. It can also be used with any Leviton 1RU Flush-Mount MTP to LC enclosure.

# FBZ



## FEATURED PRODUCTS

Vertical Patching Brackets & Blade Replacers **B42**

Replicator® Enclosures **B43**

Mainframe **B44**

## equipment-specific solutions

Levint works closely with the biggest names in active network equipment to create scalable, high-density data center networks. When combined with the latest data center switches from Arista, Brocade, Cisco, and Extreme Networks, Levint connectivity provides design flexibility for your equipment architecture. These solutions include new conversion harnesses and cassettes that break out 40GbE or 100GbE connections into individual 10GbE channels.

# EQUIPMENT-SPECIFIC SOLUTIONS | Vertical Patching Brackets & Blade Replicators

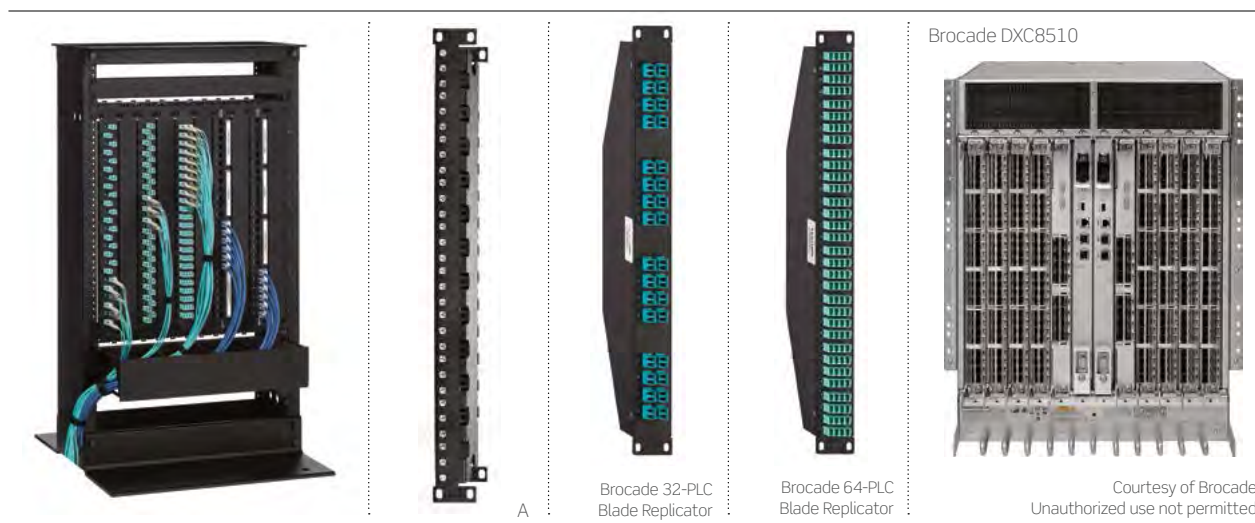

equipment-specific solutions

**FIBER**

## VERTICAL PATCHING BRACKETS

- Enable vertical mounting in a 19" rack
- Align or replicate patch panel/adaptor plate ports with the ports that reside on servers or switches within the same or adjacent rack/cabinet
- 48-port copper panels replicate typical 1G/10G copper switch blades
- 32, 48, and 64 fiber ports replicate typical fiber switch blades
- Up to ten 1RU copper/fiber patch panels and cable managers can be mounted vertically utilizing 10RU space

## BLADE REPLICATORS

- Replicators provide one-to-one Logical Port Management (LPM) replication for the high-density blade fiber switches
- Blade Replicator supports Switches and Directors from Cisco, Brocade, Arista, and Extreme
- Mounting can be done horizontally or vertically using Leviton Vertical Patching Brackets
- Blade Replicator supports 32 ports, 48 ports, and 64 ports per blade
- Replicator kits simplify ordering. Kits can include the replicated patch panel, associated trunks, MTP® panels, and harnesses

### VERTICAL PATCHING BRACKETS

DESCRIPTION	PART NO.
<b>[A]</b> Vertical Patching Bracket, 19" (set of two)	VERPB-019

### BLADE REPLICATORS

32-Port Blade, LC	RPL-xxxx32PLC*
48-Port Blade, LC	RPL-xxxx48PLC*
64-Port Blade, LC	RPL-BRCD64PLC*

xxxx = For Arista Switch (ASTA), Brocade Switch (BRCD), Cisco Switch (CSCO), Extreme Switch (EXTM).

\* = Fiber type: OM3 = 3, OM4 = 4.

For assistance configuring replicators, please call 800.722.2082.

# EQUIPMENT-SPECIFIC SOLUTIONS | Replicator® Enclosures



REPL-BRDE2400-LCMTDP0960M3C:  
Brocade 12/24k Replicator 8RU Enclosure,  
96 channel, MTP® to LC, OM3, Fiber



REPL-CSCO9513-LCMTDP5760M3C:  
Cisco 9513 Replicator 8RU Enclosure, Beige,  
288 channel, MTP to LC, OM3, Fiber

Cisco MDS 9513



Courtesy of Cisco Systems, Inc.  
Unauthorized use not permitted

equipment-specific solutions

FIBER

## REPLICATOR ENCLOSURES

- Can be configured to replicate any switch
- Unique logical port management (LPM) design
- Kits available with trunks, MTP panels, and harnesses
- Full front access to all terminations via fold-down panel
- Shallow depth allows back-to-back mounting in cabinets and 4-post racks for high-density applications
- Up to 384-channel capacity (768 fiber strands)
- Available with LC and MU connector interfaces

## TYPICAL REPLICATOR KIT TOPOLOGY

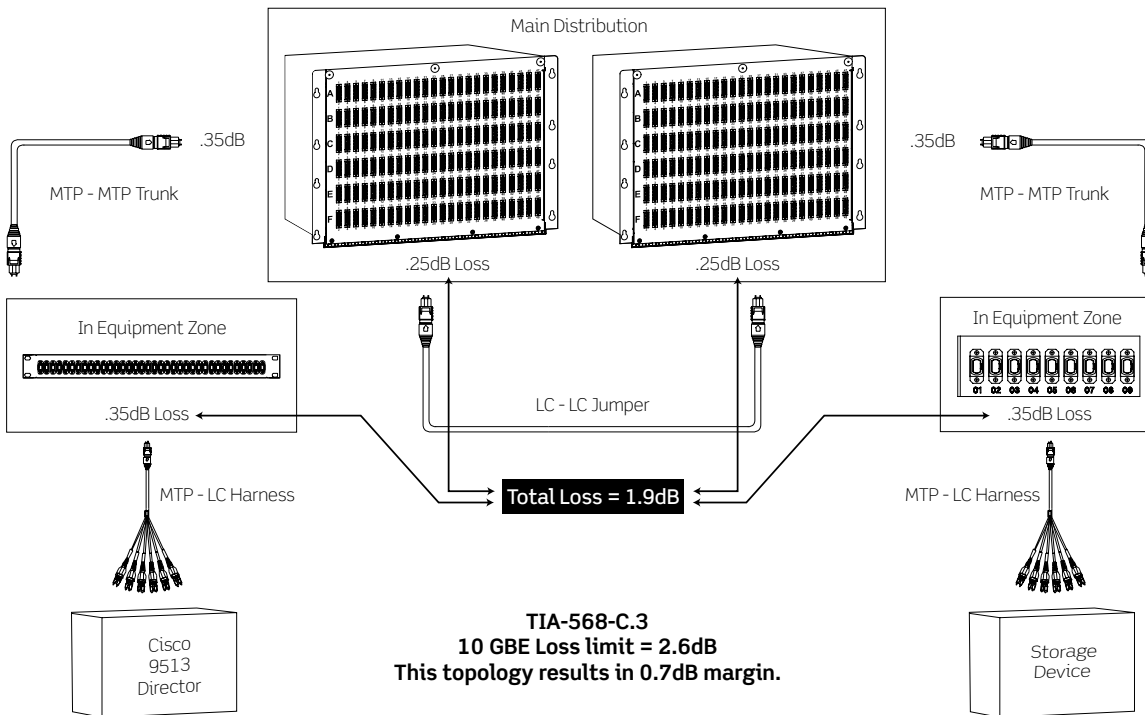

For assistance configuring  
please call 800.722.2082.



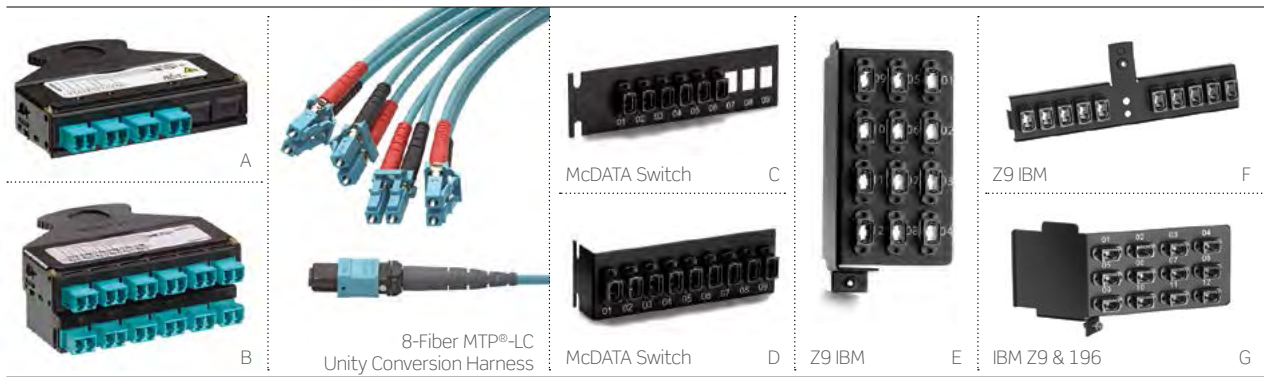

## 100G TO 10G & 40G TO 10G e2XHD CONVERSION CASSETTES

- Low-loss MTP connector 0.35dB Max IL; LC connector at 0.15dB typical IL
- Bend-insensitive fiber is low risk for pinched cables
- Compatible with reversing polarity LC Uniboot patch cords
- Cassettes fit all e2XHD panel configurations



## OPT-X® UNITY CONVERSION FIBER HARNESES

- Small diameter cable for dense connectivity
- Uses bend insensitive fiber; lowers risk for pinched cables
- Available with optional reversing polarity LC Uniboot
- Low-loss MTP connector 0.35dB Max IL

## FIBER PLUG-N-PLAY MTP BRACKETS

- Available in various sizes and configurations to accommodate 6 to 12 adapters
- Mount to back rail (right or left side) of racks and cabinets, freeing up valuable space
- Provide direct connection to the mainframe using trunk cables and MTP harnesses
- Available with shutters

### e2XHD CONVERSION CASSETTES

DESCRIPTION	PART NO.
40G to 10G OM3, 8 fiber, MTP-LC Conversion Cassettes	FME2XHD-E008CKQDJ
<b>[A]</b> 40G to 10G OM4, 8 fiber, MTP-LC Conversion Cassettes	FME2XHD-F008CKQDJ
40G to 10G OS2, 8 fiber, MTP-LC Conversion Cassettes	FME2XHD-A008CKQDJ
Single cable 100G to 10G OM3, 24 fiber, MTP-LC Conversion Cassettes	FME2XHD-E024CKQES4
<b>[B]</b> 100G to 10G OM4, 24 fiber, MTP-LC Conversion Cassettes	FME2XHD-F024CKQES4
100G to 10G OS2, 24 fiber, MTP-LC Conversion Cassettes	FME2XHD-A024CKQES4

### Make to order! OPT-X UNITY CONVERSION FIBER HARNESES

FIBER TYPE	FIBER COUNT	CONNECTOR 1ST END (MTP)	CONNECTORS 2ND END	CABLE LENGTH	BREAKOUT LENGTH (INCHES)
<ul style="list-style-type: none"> <li>• OM3</li> <li>• OM4 (aqua)</li> <li>• OM4 (violet)</li> </ul>	<ul style="list-style-type: none"> <li>• 8</li> <li>• 24</li> </ul>	<ul style="list-style-type: none"> <li>• Male</li> <li>• Female</li> </ul>	<ul style="list-style-type: none"> <li>• LC</li> <li>• Uniboot LC</li> </ul>	<ul style="list-style-type: none"> <li>• Custom lengths in feet and meters</li> </ul>	<ul style="list-style-type: none"> <li>• 12-48</li> <li>• Other</li> </ul>

For assistance customizing your harnesses, please visit [leviton.com/configurator](http://leviton.com/configurator) or call Tech Support at 800.824.3005.

### FIBER PLUG-N-PLAY MTP BRACKETS ^

DESCRIPTION	6 MTP ADAPTERS	9 MTP ADAPTERS	10 MTP ADAPTERS	12 MTP ADAPTERS
Straight Bracket w/ Adapters	<b>[C]</b> FB106-OST	FB109-OST	—	—
90° Angled Bracket w/ Adapters	FB106-090	<b>[D]</b> FB109-090	—	—
Standard 12 MTP-Adapter Bracket	—	—	—	<b>[E]</b> FB112-000
Straight Vertical MTP Bracket	—	—	<b>[F]</b> FB110-VST	—
45° Angled MTP Bracket, Left Hand Mount	—	—	—	<b>[G]</b> FB112-L45
45° Angled MTP Bracket, Right Hand Mount	—	—	—	FB112-045

^ = Minimum order quantity and lead times may apply.

Horizontal cable managers sold separately, see page C15.

# FEATURES



## FEATURED PRODUCTS

Opt-X® Unity  
40/100G System

Pre-Terminated  
Trunk Cables **B47**

Harnesses **B51**

Array Cords **B54**

Premium & Economy  
Fiber Optic Cable  
Assemblies **B55**

## pre-terminated cable assemblies & patch cords

Simplify fiber connection and termination with Leviton cable assemblies. Take advantage of our new Secure Keyed LC and Opt-X Unity 40/100G assemblies to protect and future-proof your critical networks. Pre-terminated trunk cables and harnesses, plus multimode, single-mode, and pigtail assemblies are all made to customer specifications. Choose cable type, connector combinations, length, mode, and more. Configure online at [leviton.com/configurator](http://leviton.com/configurator) or use the configurators in this catalog.

# PRE-TERMINATED CABLE ASSEMBLIES & PATCH CORDS | [Make-to-Order \(MTO\) Overview](#)

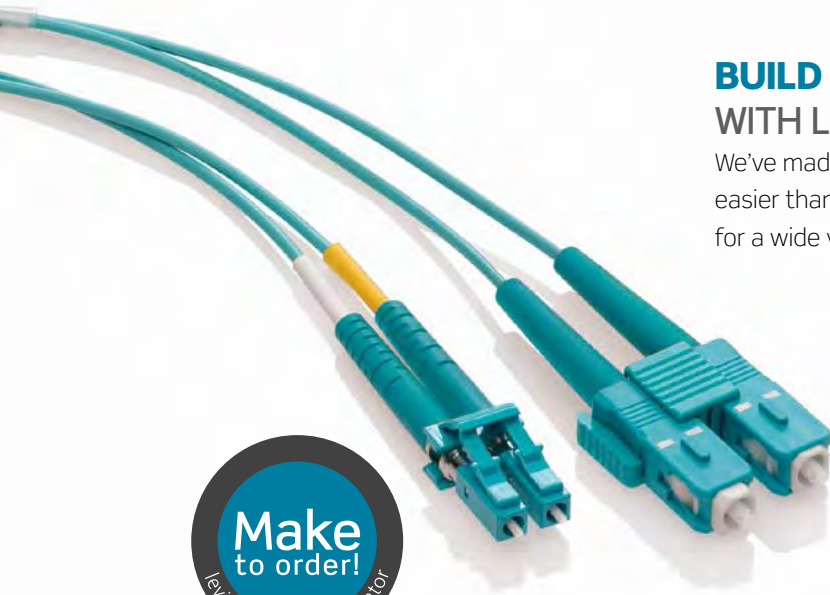

## BUILD YOUR OWN PRODUCTS WITH LEVITON'S MAKE-TO-ORDER PROGRAM

We've made building the exact solution for your network quicker and easier than ever. Rely on our innovative online custom configurators for a wide variety of fiber and copper products.

### MAKE-TO-ORDER CABLE ASSEMBLIES

- Pre-Terminated Fiber Trunks
- Fiber MTP® Harnesses
- Secure Keyed LC Cable Assemblies
- Fiber Optic Patch Cords
- Pigtailed

pre-terminated cable assemblies & patch cords

FIBER

### FIBER TRUNK CABLE DIAGRAM (CUSTOMIZE AT [LEVITON.COM/CONFIGURATOR](#))

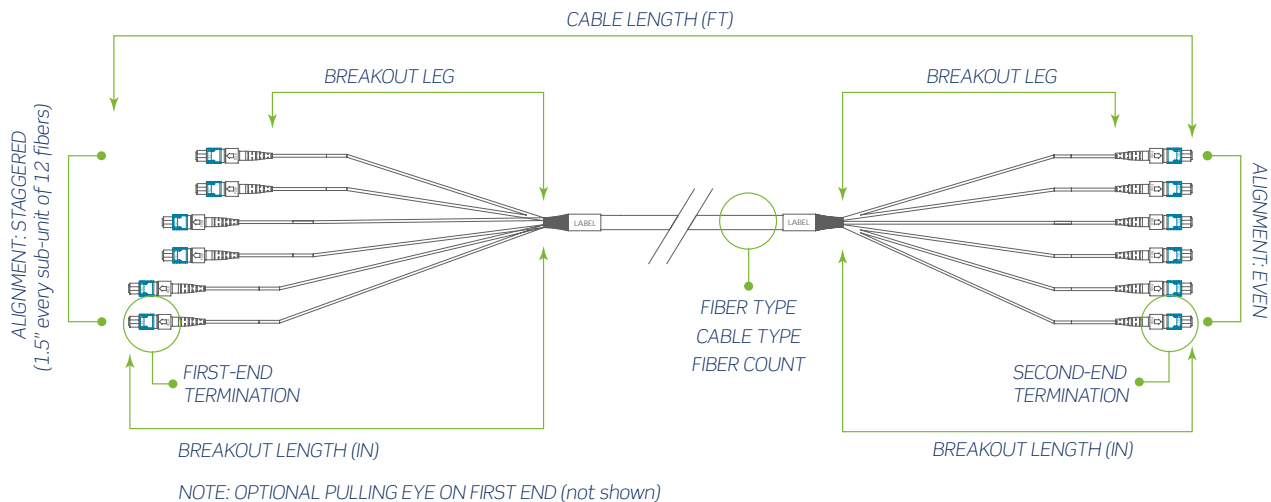

Our engineers can also work with you to design and manufacture a solution that meets your specific application needs. For questions or assistance configuring your products, please call Network Solutions Support at **800.824.3005**.

### SPOTLIGHT Secure Keyed LC Fiber System



**Leviton Secure Keyed LC Fiber Systems** prevent unauthorized and inadvertent changes in highly sensitive applications such as government data centers, telecommunications rooms, workstation areas, and secure IT networks, creating an ideal “lock-in” system. Once connected to a port, the locking design — built into the body of each duplex LC connector — prevents removal by hand, and the connector can only be removed with a matching-color extraction tool. Eight keyed connector colors are available to segregate networks. The system is made up of trunks, harnesses, patch cords, pigtailed, connectors, port protection plugs, extraction tools, and QuickPort® fiber adapters. All Secure Keyed LC assemblies and connectors work with any industry-compliant LC duplex or quad adapter.

# PRE-TERMINATED CABLE ASSEMBLIES & PATCH CORDS | Pre-Terminated Trunk Cables > Opt-X® Unity 40/100G

pre-terminated cable assemblies & patch cords

FIBER

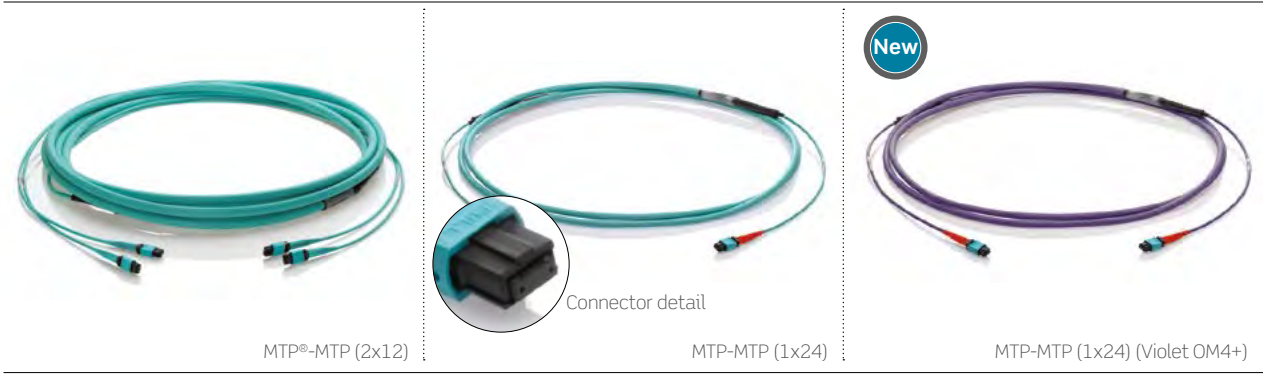

MTP®-MTP (2x12)

MTP-MTP (1x24)

MTP-MTP (1x24) (Violet OM4+)

## OPT-X UNITY 40/100G PRE-TERMINATED TRUNK CABLES

- MTP to MTP trunk cables support 40/100G speeds
- Terminations available in 8-, 12-, and 24-fiber configurations
- Migration solution to 40/100G from existing 10G networks with premium 12-fiber MTP trunk configuration
- Up to 70% faster install than field-terminated trunks
- All orders customized for cable type, length, staggering, fiber count, and labeling
- MTP polarity options are TIA methods A, B, or C (Method B is standard)
- 100% factory tested, with test results included for each assembly
- All assemblies labeled with serial number and length for traceability and easy re-order



See page B6 for Opt-X Unity 40/100G system overview.

## SPOTLIGHT Migration Path to 40G & 100G

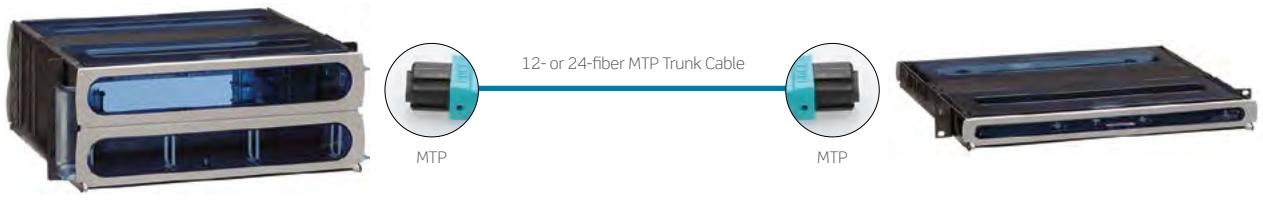

New Leviton pre-terminated MTP solutions offer an ideal migration path from 10G to 40G and 100G channels. The Opt-X Unity 40/100G system features MTP trunks, harnesses, array cords, adapter plates, and cassettes to help future-proof your networks. The Opt-X Unity system is fully compatible with Opt-X HD, Opt-X, and e2XHD footprints.

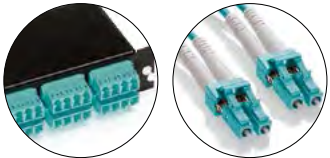

**10G**  
Leviton components for a 10G channel include 24-fiber MTP-LC cassettes and LC duplex patch cords.



**40G**  
Migration from 10G to a 40G system replaces LC with MTP components, such as 2x12-fiber to 3x8-fiber MTP cassettes and 8-fiber MTP array cords.



**100G**  
Moving from 40G to 100G replaces MTP cassettes with MTP adapter plates and uses 24-fiber MTP array cords.

# PRE-TERMINATED CABLE ASSEMBLIES & PATCH CORDS | Pre-Terminated Trunk Cables > Opt-X® Unity 40/100G

## MTP® LANE ASSIGNMENTS FOR 40/100G

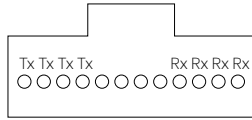

40GBASE-SR4, 8-fiber MTP

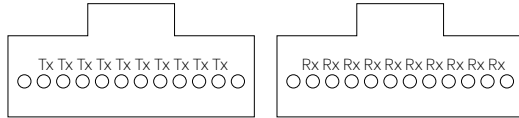

100GBASE-SR10, 2x12-fiber MTPs

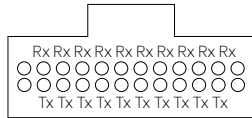

100GBASE-SR10, 24-fiber MTP

NOTE: Per IEEE802.3ba

## COLOR-CODED BOOTS ON MTP



pre-terminated cable assemblies & patch cords

FIBER

## OPT-X UNITY 40/100G MTP TRUNKS, STANDARD EXAMPLE PART NUMBERS

DESCRIPTION	PART NO.
OM3, Plenum, 24-fiber, 100 feet, pulling eye, Method B	FT-EB024JJ100F36C36CY-NNBS
OM4, Plenum, 24-fiber, 100 feet, pulling eye, Method B	FT-FB024JJ100F36C36CY-NNBS
OM4, MDP Plenum, 24-fiber, 100 feet, pulling eye, Method B - NEW MDP small O.D. cable	FT-FM024JJ100F36C36CY-NNBS
OM3, Plenum, 48-fiber, 100 feet, pulling eye, Method B	FT-EB048JJ100F36C36CY-NNBS
OM4, Plenum, 48-fiber, 100 feet, pulling eye, Method B	FT-FB048JJ100F36C36CY-NNBS
OM4, MDP Plenum, 48-fiber, 100 feet, pulling eye, Method B- NEW MDP small O.D. cable	FT-FM048JJ100F36C36CY-NNBS
OM3, Plenum, 144-fiber, 100 feet, pulling eye, Method B	FT-EB144JJ100F36C36CY-NNBS
OM4, Plenum, 144-fiber, 100 feet, pulling eye, Method B	FT-FB124JJ100F36C36CY-NNBS
OM4, MDP Plenum, 144-fiber, 100 feet, pulling eye, Method B- NEW MDP small O.D. cable	FT-FM124JJ100F36C36CY-NNBS

## Make to order! OPT-X UNITY 40/100G MTP TRUNK CABLE OPTIONS

FIBER TYPE	CABLE TYPE	FIBER COUNT	TERMINATION	CABLE LENGTH (FEET)	BREAKOUT LENGTH (INCHES)	BREAKOUT LEG TYPE FIRST- & SECOND-END TERMINATION	POLARITY	LABELING
<ul style="list-style-type: none"> <li>OM3</li> <li>OM4 (aqua)</li> <li>OM4 (violet)</li> <li>OM4+ (aqua)</li> <li>OM4+ (violet)</li> <li>OS2</li> </ul>	<ul style="list-style-type: none"> <li>Riser I/O Dry Loose Tube</li> <li>Plenum I/O Dry Loose Tube (standard)</li> <li>Plenum Armor I/O Dry Loose Tube</li> <li>LSZH I/O Dry Loose Tube</li> <li>MDP Plenum</li> <li>MDP Plenum Armor</li> </ul>	<ul style="list-style-type: none"> <li>12</li> <li>24</li> <li>36</li> <li>48</li> <li>72</li> <li>96</li> <li>144</li> </ul>	<p><b>FIRST END</b></p> <ul style="list-style-type: none"> <li>24 F MTP (male)</li> <li>24 F MTP (female)</li> <li>Premium 12 F MTP (male)</li> <li>Premium 12 F MTP (female)</li> </ul> <p><b>SECOND END</b></p> <ul style="list-style-type: none"> <li>24 F MTP (male)</li> <li>24 F MTP (female)</li> <li>Premium 12 F MTP (male)</li> <li>Premium 12 F MTP (female)</li> </ul>	<ul style="list-style-type: none"> <li>1-999</li> </ul>	<ul style="list-style-type: none"> <li>12-99 (36" is typical)</li> </ul>	<ul style="list-style-type: none"> <li>3-mm Jacketed 12-Fiber</li> <li>3.8-mm Jacketed 24-Fiber</li> </ul>	<ul style="list-style-type: none"> <li>MTP Method A</li> <li>MTP Method B (standard)</li> <li>MTP Method C</li> </ul>	<ul style="list-style-type: none"> <li>Standard</li> <li>Custom</li> </ul>

For assistance customizing your Opt-X Unity trunks, please visit [leviton.com/configurator](http://leviton.com/configurator) or call Tech Support at 800.824.3005.

# PRE-TERMINATED CABLE ASSEMBLIES & PATCH CORDS | Pre-Terminated Trunk Cables > Standard



LC-LC

MTP®-LC

LC Fiber Trunk

pre-terminated cable assemblies & patch cords

FIBER

## PRE-TERMINATED TRUNK CABLES

- Plug-n-play fiber eliminates the need for field terminations or splices
- Up to 70% faster install than field-terminated trunks
- All orders customized for length, staggering, connector type, breakout style, fiber count, and labeling
- Discrete connectors are heat cured and use ceramic ferrules and sleeves for optimal performance
- Optional pulling eye protects connectors and eases installation
- Available in LC, SC, ST, MU, and MTP
- MTP polarity options are TIA methods A, B, or C
- Industry-best turnaround time on delivery
- 100% factory tested, with test results included for each assembly
- All assemblies labeled with serial number and length for traceability and easy re-order



PRE-TERMINATED TRUNK CABLES, STANDARD EXAMPLE PART NUMBERS	
DESCRIPTION	PART NO.
OM3, plenum, 24-fiber LC-LC, 50 feet, pulling eye, Method C	FT-EB024CC050F36C36CY-NNBS
OM3, plenum, 24-fiber MTP-MTP, 50 feet, pulling eye, Method B	FT-EB024SS050F36C36CY-NNCS
OM4, plenum, 24-fiber LC-LC, 50 feet, pulling eye, Method C	FT-FB024CC050F36C36CY-NNBS
OM4, plenum, 24-fiber MTP-MTP, 50 feet, pulling eye, Method B	FT-FB024SS050F36C36CY-NNCS
OM3, plenum, 48-fiber LC-LC, 100 feet, pulling eye, Method C	FT-EB048CC100F36C36CY-NNBS
OM3, plenum, 48-fiber MTP-MTP, 100 feet, pulling eye, Method B	FT-EB048SS100F36C36CY-NNCS
OM4, plenum, 48-fiber LC-LC, 100 feet, pulling eye, Method C	FT-FB048CC100F36C36CY-NNBS
OM4, plenum, 48-fiber MTP-MTP, 100 feet, pulling eye, Method B	FT-FB048SS100F36C36CY-NNCS

Make to order!		PRE-TERMINATED TRUNK CABLE OPTIONS							
FIBER TYPE	CABLE TYPE	FIBER COUNT	TERMINATION (FIRST END)	TERMINATION (SECOND END)	CABLE LENGTH (FEET)	BREAKOUT LENGTH (INCHES)	BREAKOUT-LEG TYPE FIRST- & SECOND-END TERMINATION	POLARITY	LABELING
<ul style="list-style-type: none"> <li>• OM1</li> <li>• OM2</li> <li>• OM3</li> <li>• OM4 (aqua)</li> <li>• OM4 (violet)</li> <li>• OM4+</li> <li>• OS2</li> </ul>	<ul style="list-style-type: none"> <li>• Riser I/O Dry Loose Tube</li> <li>• Plenum I/O Dry Loose Tube (standard)</li> <li>• Plenum Armor I/O Dry Loose Tube</li> <li>• Riser Distribution</li> <li>• Plenum Distribution</li> <li>• LSZH I/O Dry Loose Tube</li> <li>• MDP Plenum</li> <li>• MDP Plenum Armor</li> </ul>	<ul style="list-style-type: none"> <li>• 4</li> <li>• 6</li> <li>• 12</li> <li>• 24</li> <li>• 36</li> <li>• 48</li> <li>• 72</li> <li>• 96</li> <li>• 144</li> </ul>	<ul style="list-style-type: none"> <li>• LC (duplex clips)</li> <li>• LC/APC</li> <li>• LC (uniboot)</li> <li>• SC</li> <li>• SC/APC</li> <li>• ST</li> <li>• MU</li> <li>• MTP (female)</li> <li>• MTP (male)</li> </ul>	<ul style="list-style-type: none"> <li>• LC (duplex clips)</li> <li>• LC/APC</li> <li>• LC (uniboot)</li> <li>• SC</li> <li>• SC/APC</li> <li>• ST</li> <li>• MU</li> <li>• MTP (female)</li> <li>• MTP (male)</li> <li>• Pigtail</li> </ul>	<ul style="list-style-type: none"> <li>• 1-999</li> </ul>	<ul style="list-style-type: none"> <li>• 12-99 (36" is typical)</li> </ul>	<p><b>FIRST END</b></p> <ul style="list-style-type: none"> <li>• 900 µm buffered fiber (for SC, ST, LC, MU)</li> <li>• 2 mm jacketed fiber (for LC, SC, MU)</li> <li>• 3 mm jacketed fiber (for SC, ST, LC, MTP)</li> </ul> <p><b>SECOND END</b></p> <ul style="list-style-type: none"> <li>• 900 µm buffered fiber (for LC, SC, ST, MU)</li> <li>• 2 mm jacketed fiber (for LC, SC, MU)</li> <li>• 3 mm jacketed fiber (for LC, SC, ST, MTP)</li> </ul>	<ul style="list-style-type: none"> <li>• MTP Method A</li> <li>• MTP Method B</li> <li>• MTP Method C</li> <li>• A-A</li> <li>• A-B</li> </ul>	<ul style="list-style-type: none"> <li>• Standard</li> <li>• Custom</li> </ul>

For assistance customizing your trunk cables, please visit [leviton.com/configurator](http://leviton.com/configurator) or call Tech Support at 800.824.3005.

# PRE-TERMINATED CABLE ASSEMBLIES & PATCH CORDS | Pre-Terminated Trunk Cables > Secure Keyed LC

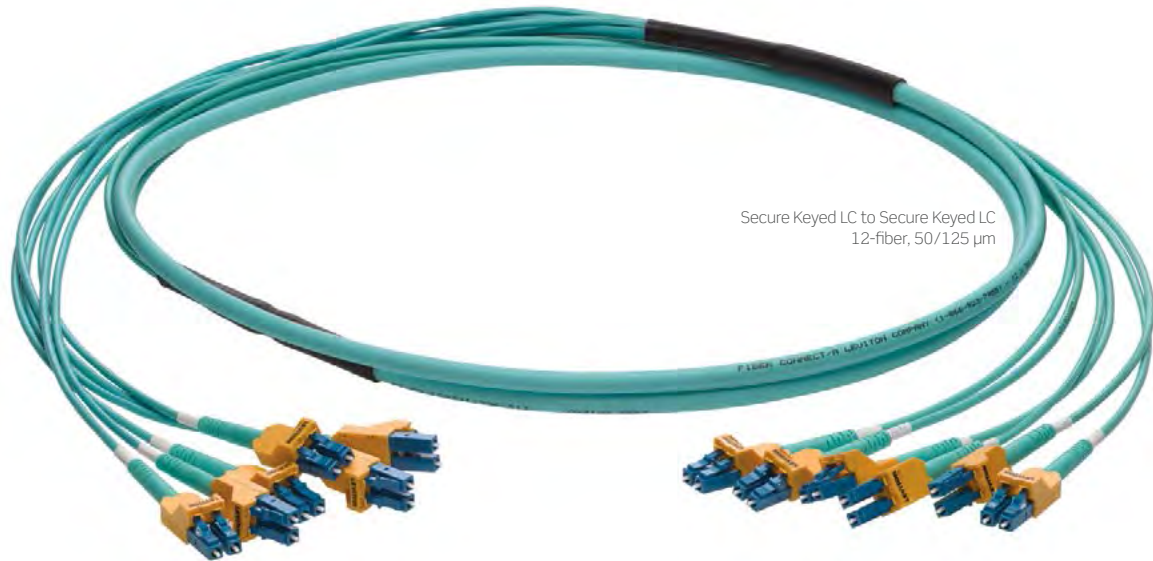

pre-terminated cable assemblies & patch cords

**FIBER**

## PRE-TERMINATED SECURE KEYED LC TRUNK CABLES

- Uniboot design prevents unauthorized and inadvertent moves, adds, and changes (MACs)
- Duplex LC connectors can only be removed with matching-color extraction tool
- Choose from eight colors to segregate and secure networks
- Duplex LC connectors plug into any industry-compliant LC adapter or interface
- Standard polarity: A-B or MTP® Method C; others available
- Standard breakout lengths can be staggered for better cable routing and management
- Trunks over 125' long are shipped on spools, or upon request for shorter lengths
- Pulling eye option available



### Make to order! SECURE KEYED LC FIBER TRUNK CABLE OPTIONS

KEYED COLOR	FIBER TYPE	CABLE TYPE	FIBER COUNT	TERMINATION	CABLE LENGTH (FEET)	1ST & 2ND BREAKOUT (INCHES)	BREAKOUT LEG	POLARITY	LABELING
<ul style="list-style-type: none"> <li>• White</li> <li>• Yellow</li> <li>• Orange</li> <li>• Red</li> <li>• Blue</li> <li>• Green</li> <li>• Slate</li> <li>• Black</li> </ul>	<ul style="list-style-type: none"> <li>• OM1</li> <li>• OM2</li> <li>• OM3</li> <li>• OM4 (aqua)</li> <li>• OM4 (violet)</li> <li>• OS2</li> </ul>	<ul style="list-style-type: none"> <li>• Riser I/O Dry Loose Tube</li> <li>• Plenum I/O Dry Loose Tube (standard)</li> <li>• Plenum Armor I/O Dry Loose Tube</li> <li>• Riser Distribution</li> <li>• Plenum Distribution</li> </ul>	<ul style="list-style-type: none"> <li>• 4</li> <li>• 6</li> <li>• 12</li> <li>• 24</li> <li>• 36</li> <li>• 48</li> <li>• 72</li> <li>• 96</li> <li>• 144</li> </ul>	<p><b>FIRST END</b></p> <ul style="list-style-type: none"> <li>• Secure Keyed LC Duplex (uniboot)</li> </ul> <p><b>SECOND END</b></p> <ul style="list-style-type: none"> <li>• LC (duplex clip)</li> <li>• LC/APC</li> <li>• LC Duplex (uniboot)</li> <li>• SC (duplex clip)</li> <li>• SC/APC</li> <li>• ST</li> <li>• MU</li> <li>• Secured Keyed LC</li> <li>• MTP (female)</li> <li>• MTP (male)</li> <li>• Pigtail</li> </ul>	<ul style="list-style-type: none"> <li>• 001-999</li> </ul>	<ul style="list-style-type: none"> <li>• 12-99 (36" is typical)</li> </ul>	<ul style="list-style-type: none"> <li>• 900 μm buffered fiber</li> <li>• 2 mm jacketed fiber</li> <li>• 3 mm jacketed fiber</li> </ul>	<ul style="list-style-type: none"> <li>• MTP Method A</li> <li>• MTP Method B</li> <li>• MTP Method C</li> </ul>	<ul style="list-style-type: none"> <li>• Standard</li> <li>• Custom</li> </ul>

For assistance customizing your trunk cables, please visit [leviton.com/configurator](http://leviton.com/configurator) or call Tech Support at 800.824.3005.

# PRE-TERMINATED CABLE ASSEMBLIES & PATCH CORDS | MTP® Array Harnesses > Opt-X® Unity 40/100G

pre-terminated cable assemblies & patch cords

FIBER



## OPT-X UNITY 40/100G MTP ARRAY HARNESSES

- Pre-terminated MTP to MTP connectors in laser-optimized multimode
- Custom short-length cable for cabinet/rack patching
- Custom staggering available
- MTP polarity options are TIA method A, B, or C (Method B is standard)
- Used in conjunction with MTP brackets (Zero-U) or adapter plates
- 100% factory tested, with test results included for each assembly
- All assemblies labeled with serial number and length for traceability and easy re-order
- For use in attaching directly to 40/100G transceivers
- Used in 12- or 24-fiber cabling systems
- Color-coded boots

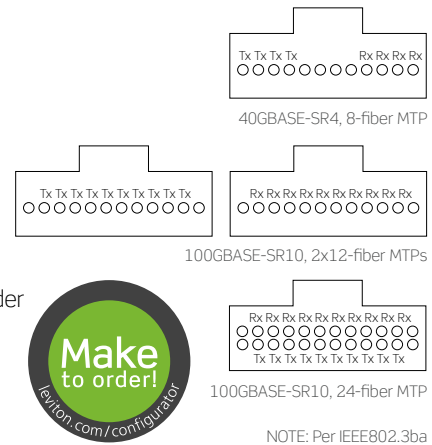

Make to order!		OPT-X UNITY 40/100G MTP ARRAY HARNESS OPTIONS				
FIBER TYPE	CABLE TYPE	FIBER COUNT	TERMINATION	CABLE LENGTH (FEET)	BREAKOUT LENGTH (INCHES)	POLARITY
<ul style="list-style-type: none"> <li>• OM3</li> <li>• OM4 (aqua)</li> <li>• OM4 (violet)</li> </ul>	<ul style="list-style-type: none"> <li>• Harness</li> </ul>	<ul style="list-style-type: none"> <li>• 24</li> </ul>	<p><b>FIRST END</b></p> <ul style="list-style-type: none"> <li>• 24 F MTP (male)</li> <li>• 24 F MTP (female)</li> <li>• Premium 12 F MTP (male)</li> <li>• Premium 12 F MTP (female)</li> </ul> <p><b>SECOND END</b></p> <ul style="list-style-type: none"> <li>• Premium 12 F MTP (male)</li> <li>• Premium 12 F MTP (female)</li> <li>• Premium 8 F MTP (female)</li> <li>• Premium 8 F MTP (male)</li> </ul>	<ul style="list-style-type: none"> <li>• 3</li> <li>• 5</li> <li>• 6</li> <li>• 8</li> <li>• Other</li> </ul>	<ul style="list-style-type: none"> <li>• 0-48</li> <li>• Other</li> </ul>	<ul style="list-style-type: none"> <li>• MTP Method A</li> <li>• MTP Method B (standard)</li> <li>• MTP Method C</li> </ul>

For assistance customizing your harnesses, please visit [leviton.com/configurator](http://leviton.com/configurator) or call Tech Support at 800.824.3005.



## The Industry's Best Service & Support

**JIM MARTIN, RCDD**

Network Solutions Regional Sales Manager

Jim has played a significant role in advancing the completion of key projects throughout the United States. A veteran in the industry, he has built strong, trusted relationships with customers, contractors, distributors, and manufacturers across the upper Midwest. Jim continuously leverages his expertise to provide comprehensive service and support throughout all phases of the sales and channel management cycle.



# PRE-TERMINATED CABLE ASSEMBLIES & PATCH CORDS | Harnesses

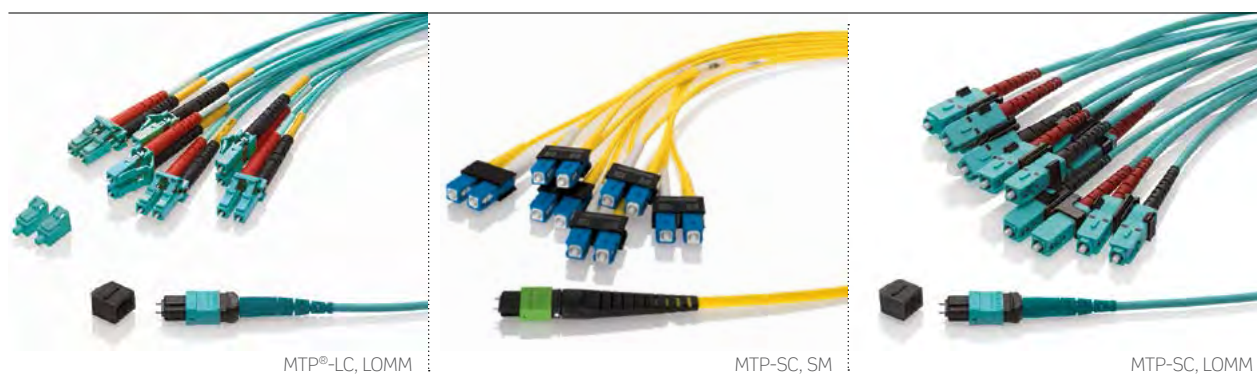

pre-terminated cable assemblies & patch cords

**FIBER**

## HARNESSES

- Pre-terminated MTP to discrete connectors (LC, SC, ST, MU) in all fiber types
- Custom short-length cable reduces congestion in cabinet/rack patching applications
- Custom staggering available
- Straight polarity configuration
- Used in conjunction with MTP brackets (Zero-U) or Flush-Mount Series MTP 1RU panels as plug-n-play solution
- Used as direct connect into SAN equipment
- 100% factory tested, with test results included for each assembly
- All assemblies labeled with serial number and length for traceability and easy re-order
- Small diameter cable for dense connectivity
- Available in 50  $\mu$ m OM3 and OM4 multimode fiber
- Uses bend-insensitive fiber; lowers risk for pinched cables
- Available with optional reversing polarity LC Uniboot
- SFP+ conversion cassettes available in e2XHD and Opt-X footprints



Make to order!		HARNESS OPTIONS				
FIBER TYPE	CABLE TYPE	FIBER COUNT	TERMINATION	CABLE LENGTH (FEET)	BREAKOUT LENGTH (INCHES)	POLARITY
<ul style="list-style-type: none"> <li>• OM1</li> <li>• OM2</li> <li>• OM3</li> <li>• OM4 (aqua)</li> <li>• OM4 (violet)</li> <li>• OS2</li> </ul>	<ul style="list-style-type: none"> <li>• Harness</li> </ul>	<ul style="list-style-type: none"> <li>• 8</li> <li>• 12</li> <li>• 24</li> </ul>	<p><b>FIRST END</b></p> <ul style="list-style-type: none"> <li>• 12 F MTP (female)</li> <li>• 12 F MTP (male)</li> </ul> <p><b>SECOND END</b></p> <ul style="list-style-type: none"> <li>• LC</li> <li>• LC (uniboot)</li> <li>• SC</li> <li>• ST</li> <li>• MU</li> </ul>	<ul style="list-style-type: none"> <li>• 3</li> <li>• 5</li> <li>• 6</li> <li>• 8</li> <li>• Other</li> </ul>	<ul style="list-style-type: none"> <li>• 0-48</li> <li>• Other</li> </ul>	<ul style="list-style-type: none"> <li>• A - A</li> <li>• A - B</li> </ul>

For assistance customizing your harnesses, please visit [leviton.com/configurator](http://leviton.com/configurator) or call Tech Support at 800.824.3005.

## SPOTLIGHT

### Conversion Harnesses

The **Opt-X Unity Conversion Harnesses** connect to electronics with LC-style ports and aggregate 10G ports to a 40G or 100G port. Available in 50  $\mu$ m OM3 and OM4 multimode fiber with optional reversing polarity LC Uniboot. Conversion Harnesses feature a small diameter cable for dense connectivity and bend-insensitive fiber to lower risk of pinched cables. Conversion cassettes are also available in an e2XHD footprint. More information on page B44.

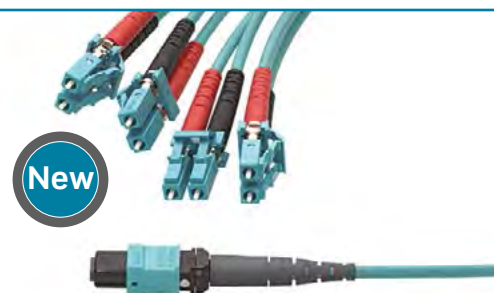

# PRE-TERMINATED CABLE ASSEMBLIES & PATCH CORDS | [Harnesses](#) > [Secure Keyed LC MTP®](#)

pre-terminated cable assemblies & patch cords

FIBER

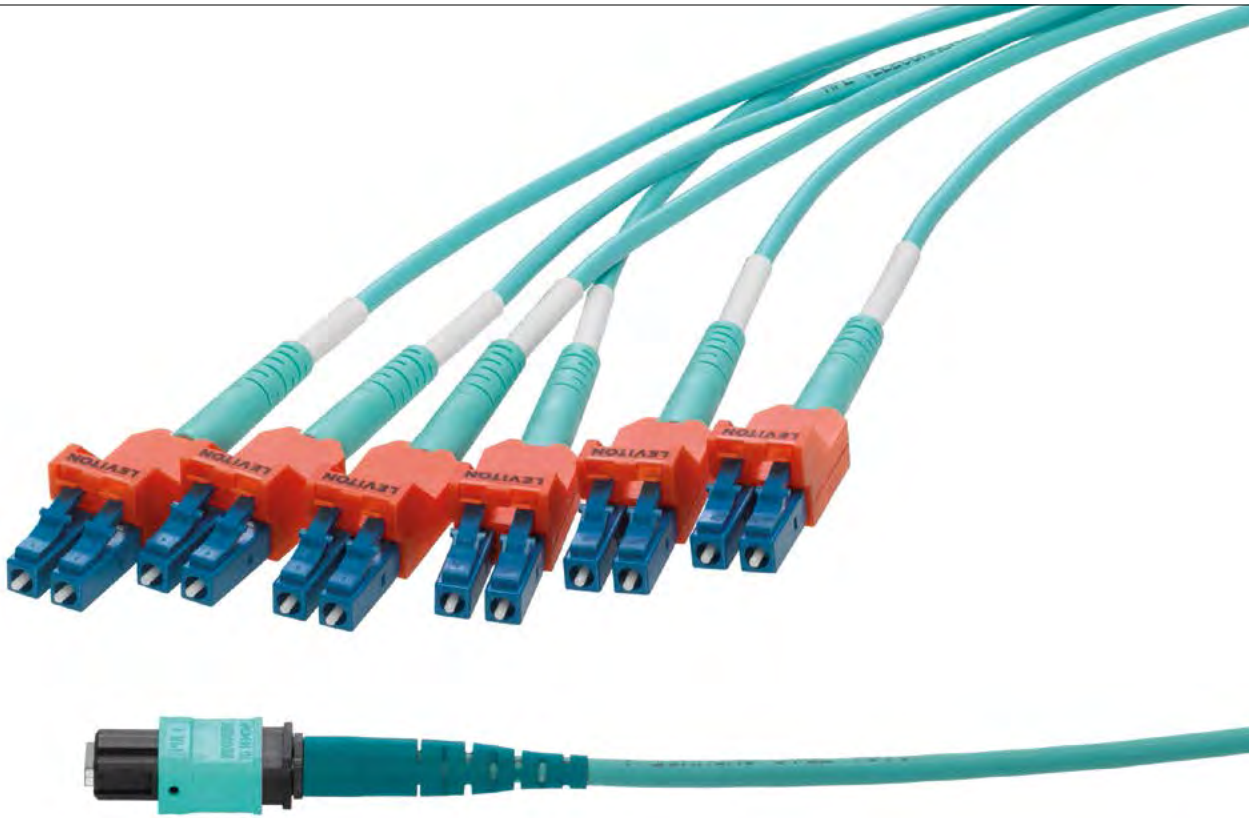

Secure Keyed MTP-LC Harness

## SECURE KEYED LC HARNESSES

- Uniboot design prevents unauthorized and inadvertent moves, adds, and changes (MACs)
- Duplex LC connectors can only be removed with matching-color extraction tool
- Choose from eight colors to segregate and secure networks
- Duplex LC connectors plug into any industry-compliant LC adapter or interface
- Polarity is A to A
- Harnesses are part of the Leviton Make-to-Order (MTO) program



Make to order!		SECURE KEYED LC MTP-LC HARNESS OPTIONS				
KEYED COLOR	FIBER TYPE	CABLE TYPE	FIBER COUNT	TERMINATION	CABLE LENGTH (FEET)	1ST & 2ND BREAKOUT (INCHES)
<ul style="list-style-type: none"> <li>• White</li> <li>• Yellow</li> <li>• Orange</li> <li>• Red</li> <li>• Blue</li> <li>• Green</li> <li>• Slate</li> <li>• Black</li> </ul>	<ul style="list-style-type: none"> <li>• OS2</li> <li>• OM2</li> <li>• OM1</li> <li>• OM3</li> <li>• OM4 (aqua)</li> <li>• OM4 (violet)</li> </ul>	<ul style="list-style-type: none"> <li>• Harness</li> </ul>	<ul style="list-style-type: none"> <li>• 12</li> <li>• 24</li> </ul>	<p><b>FIRST END</b></p> <ul style="list-style-type: none"> <li>• MTP (female) (standard)</li> <li>• MTP (male)</li> </ul> <p><b>SECOND END</b></p> <ul style="list-style-type: none"> <li>• Secure Keyed LC Duplex (uni-body)</li> </ul>	<ul style="list-style-type: none"> <li>• 3</li> <li>• 5</li> <li>• 6</li> <li>• 8</li> <li>• Other</li> </ul>	<ul style="list-style-type: none"> <li>• 0-48</li> </ul>

For assistance customizing your harnesses, please visit [leviton.com/configurator](http://leviton.com/configurator) or call Tech Support at 800.824.3005.

# PRE-TERMINATED CABLE ASSEMBLIES & PATCH CORDS | Opt-X® Unity 40/100G Array Cords

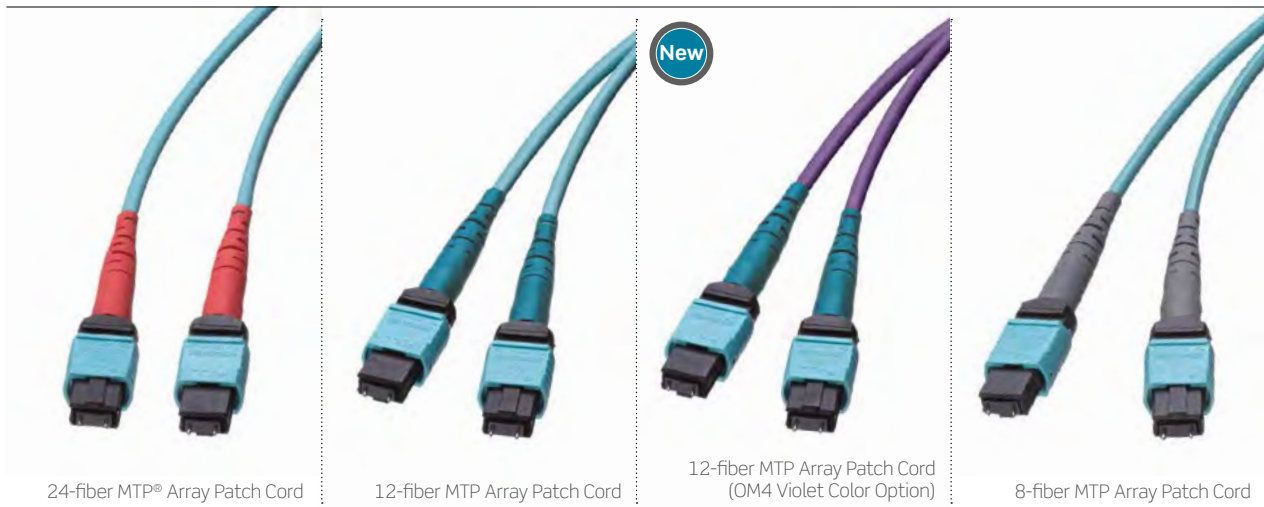

pre-terminated cable assemblies & patch cords

**FIBER**

## OPT-X UNITY 40/100G MTP ARRAY CORDS

- 50/125 µm laser-optimized multimode, OM3 and OM4
- 8-, 12-, and 24-fiber MTP array cords offer migration path from 10G to 40/100G
- Available in lengths of 1, 2, 3, 5, and 10 meters
- See page B6 for Opt-X Unity 40/100G system overview



### OPT-X UNITY 40/100G MTP ARRAY CORDS, POPULAR CONFIGURATIONS

DESCRIPTION	PART NO.
MTP (female) to MTP (female), 8 fiber, Method B, OM3, 3 meters	5L8MM-B03M
MTP (female) to MTP (female), 8 fiber, Method B, OM4, 3 meters	548MM-B03M
MTP (female) to MTP (female), 8 fiber, Method A, OM3, 3 meters	5L8MM-A03M
MTP (female) to MTP (female), 8 fiber, Method A, OM4, 3 meters	548MM-A03M
MTP (female) to MTP (female), 12 fiber, Method B, OM3, 3 meters	5L2LL-B03M
MTP (female) to MTP (female), 12 fiber, Method B, OM4, 3 meters	542LL-B03M
MTP (female) to MTP (female), 12 fiber, Method A, OM3, 3 meters	5L2LL-A03M
MTP (female) to MTP (female), 12 fiber, Method A, OM4, 3 meters	542LL-A03M
MTP (female) to MTP (female), 24 fiber, Method B, OM3, 3 meters	5L4JJ-B03M

### Make to order! OPT-X UNITY MTP ARRAY CORDS

FIBER TYPE	FIBER COUNT	TERMINATION	CABLE LENGTH (FEET)	POLARITY
<ul style="list-style-type: none"> <li>• OM3</li> <li>• OM4 (aqua)</li> <li>• OM4 (violet)</li> </ul>	<ul style="list-style-type: none"> <li>• 8</li> <li>• 12</li> <li>• 24</li> </ul>	<p><b>FIRST END</b></p> <ul style="list-style-type: none"> <li>• 8-fiber MTP (male)</li> <li>• 8-fiber MTP (female)</li> <li>• 12-fiber MTP (male)</li> <li>• 12-fiber MTP (female)</li> <li>• 24-fiber MTP (male)</li> <li>• 24-fiber MTP (female)</li> </ul> <p><b>SECOND END</b></p> <ul style="list-style-type: none"> <li>• 8-fiber MTP (male)</li> <li>• 8-fiber MTP (female)</li> <li>• 12-fiber MTP (male)</li> <li>• 12-fiber MTP (female)</li> <li>• 24-fiber MTP (male)</li> <li>• 24-fiber MTP (female)</li> </ul>	<ul style="list-style-type: none"> <li>• Custom lengths in feet and meters</li> </ul>	<ul style="list-style-type: none"> <li>• MTP Method A</li> <li>• MTP Method B</li> <li>• MTP Method C</li> </ul>

For assistance customizing your array cords, please visit [leviton.com/configurator](http://leviton.com/configurator) or call Tech Support at 800.824.3005.

# PRE-TERMINATED CABLE ASSEMBLIES & PATCH CORDS | Premium Patch Cords & Pigtails

pre-terminated cable assemblies & patch cords

FIBER

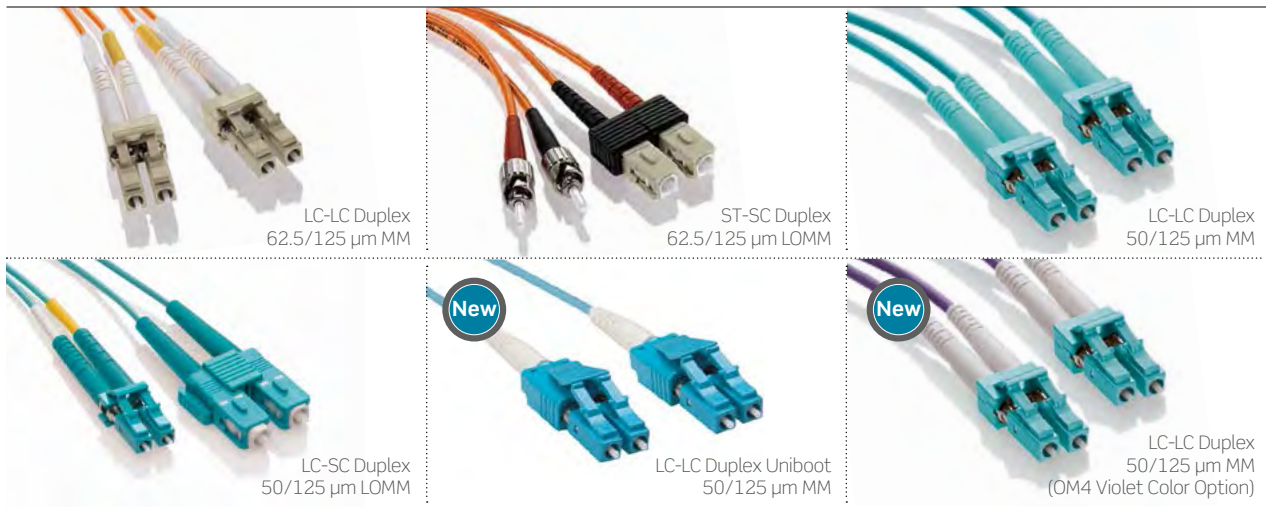

## PREMIUM PATCH CORDS

- Available in standard SC, ST, LC, or hybrid options
- Riser, plenum, and Low-Smoke Zero-Halogen (LSZH) cable
- < 0.25 dB insertion loss maximum, > 25 dB back reflection for multimode
- < 0.25 dB insertion loss maximum, > 55 dB (UPC)/-65 dB (APC) for single mode
- Polarity reversal LC connector option
- 100% factory tested
- TIA color-coded connectors
- Quick-turnaround delivery available



Make to order! PREMIUM FIBER OPTIC PATCH CORD & PIGTAIL OPTIONS			
CORE STYLE/POLISH TYPE	CABLE TYPE	CONNECTOR COMBINATIONS	CABLE LENGTH (FEET)
<b>MULTIMODE CORE</b> <ul style="list-style-type: none"> <li>• 62.5/125 μm (OM1)</li> <li>• 50/125 μm (OM2)</li> <li>• 50/125 μm laser optimized (10G-300 m) (OM3)</li> <li>• 50/125 μm laser optimized (10G-550 m) (OM4)</li> </ul>	<ul style="list-style-type: none"> <li>• Simplex (riser)</li> <li>• Duplex (riser)</li> <li>• Simplex (plenum)</li> <li>• Duplex (plenum)</li> <li>• Simplex (LSZH)</li> <li>• Duplex (LSZH)</li> <li>• Pigtail</li> </ul>	<ul style="list-style-type: none"> <li>• LC to LC</li> <li>• SC to SC</li> <li>• ST to ST</li> <li>• Reverse Polarity Uniboot</li> <li>• Pigtail</li> </ul>	<ul style="list-style-type: none"> <li>• 1-999</li> </ul>
<b>SINGLE-MODE CORE</b> <ul style="list-style-type: none"> <li>• UPC Polish (ultra physical contact)</li> <li>• APC Polish (angle physical contact)</li> </ul>			

For assistance customizing your patch cords and pigtails, please visit [leviton.com/configurator](http://leviton.com/configurator) or call Tech Support at 800.824.3005.

## SPOTLIGHT LC Uniboot Polarity Reversal



**LC Uniboot Polarity Reversal connector** includes a finger-latch release that eliminates the need for tools when making the polarity change. It is color-coded and labeled "A" and "B" to provide visual references when making a polarity flip. The uniboot design is compatible with FOCIS-compliant duplex connectors and transceivers using the LC interface. The uniboot is available on 2.0 mm round cable, and will also support legacy applications using 2.9 mm cable.

# PRE-TERMINATED CABLE ASSEMBLIES & PATCH CORDS | Economy Patch Cords



## ECONOMY MULTIMODE PATCH CORDS

- Available in duplex configurations and lengths
- Industry-standard connector options
- Industry-standard test requirements
- < 0.3 dB insertion loss maximum, > 25 dB back reflection
- 100% factory tested
- Many fiber options: OM1, OM2, OM3, and OM4
- All cables are pre-labeled and individually bagged
- Quick-turnaround delivery available

62.5/125 μM MULTIMODE (OM1) OFNR DUPLEX		
DESCRIPTION	LENGTH (METERS)	DUPLEX
LC-LC	1	62DLC-M01
LC-LC	2	62DLC-M02
LC-LC	3	62DLC-M03
LC-LC	5	62DLC-M05
LC-LC	10	62DLC-M10
SC-LC	1	62DCL-M01
SC-LC	2	62DCL-M02
SC-LC	3	62DCL-M03
SC-LC	5	62DCL-M05
SC-LC	10	62DCL-M10
SC-SC	1	62DSC-M01
SC-SC	2	62DSC-M02
SC-SC	3	62DSC-M03
SC-SC	5	62DSC-M05
SC-SC	10	62DSC-M10
SC-ST	1	62DCT-M01
SC-ST	2	62DCT-M02
SC-ST	3	62DCT-M03
SC-ST	5	62DCT-M05
SC-ST	10	62DCT-M10
ST-ST	1	62DST-M01
ST-ST	2	62DST-M02
ST-ST	3	62DST-M03
ST-ST	5	62DST-M05
ST-ST	10	62DST-M10

50/125 μM MULTIMODE (OM2) OFNR DUPLEX		
DESCRIPTION	LENGTH (METERS)	DUPLEX
LC-LC	1	50DLC-M01
LC-LC	2	50DLC-M02
LC-LC	3	50DLC-M03
LC-LC	5	50DLC-M05
LC-LC	10	50DLC-M10
SC-LC	1	50DCL-M01
SC-LC	2	50DCL-M02
SC-LC	3	50DCL-M03
SC-LC	5	50DCL-M05
SC-LC	10	50DCL-M10
SC-SC	1	50DSC-M01
SC-SC	2	50DSC-M02
SC-SC	3	50DSC-M03
SC-SC	5	50DSC-M05
SC-SC	10	50DSC-M10
ST-ST	1	50DST-M01
ST-ST	2	50DST-M02
ST-ST	3	50DST-M03
ST-ST	5	50DST-M05
ST-ST	10	50DST-M10

50/125 μM LOMM (OM3) OFNR DUPLEX		
LC-LC	1	5LDLC-M01
LC-LC	2	5LDLC-M02
LC-LC	3	5LDLC-M03
LC-LC	5	5LDLC-M05
LC-LC	10	5LDLC-M10
SC-LC	1	5LDCL-M01
SC-LC	2	5LDCL-M02
SC-LC	3	5LDCL-M03
SC-LC	5	5LDCL-M05
SC-LC	10	5LDCL-M10
SC-SC	1	5LDSC-M01
SC-SC	2	5LDSC-M02
SC-SC	3	5LDSC-M03
SC-SC	5	5LDSC-M05
SC-SC	10	5LDSC-M10

50/125 μM LOMM (OM4) OFNR DUPLEX		
LC-LC	1	54DLC-M01
LC-LC	3	54DLC-M03
LC-LC	5	54DLC-M05
LC-LC	10	54DLC-M10
SC-LC	1	54DCL-M01
SC-LC	3	54DCL-M03
SC-LC	5	54DCL-M05
SC-LC	10	54DCL-M10

pre-terminated cable assemblies & patch cords

FIBER

# PRE-TERMINATED CABLE ASSEMBLIES & PATCH CORDS | Economy Patch Cords & Pigtails

pre-terminated cable assemblies & patch cords

FIBER

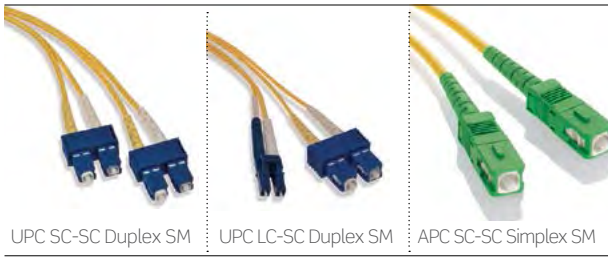

UPC SC-SC Duplex SM    UPC LC-SC Duplex SM    APC SC-SC Simplex SM

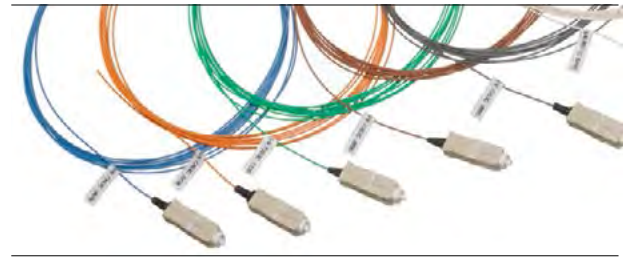

## ECONOMY SINGLE-MODE PATCH CORDS

- Available in standard LC, SC, ST, or hybrid options
- Riser-rated duplex zip-cord single-mode cable
- UPC or APC polish-style connectors
- < 0.3 dB insertion loss, -55 dB (UPC) / -65 dB (APC) back reflection
- Low-Smoke Zero-Halogen (LSZH) OS2 available by special order

9/125 μM SINGLE-MODE PATCH CORDS (OS1)	
DESCRIPTION	DUPLEX
LC-LC	UPDLC-S**
SC-LC	UPDCL-S**
SC-SC	UPDSC-S**
SC-ST	UPDCT-S**
ST-ST	UPDST-S**

\*\* = Length in meters. (01), (02), (03), (05), (10)

APC SINGLE-MODE PATCH CORDS (OS2)		
DESCRIPTION	LENGTH (METERS)	SIMPLEX
SC-SC	1	APSSC-S01
SC-SC	2	APSSC-S02
SC-SC	3	APSSC-S03
SC-SC	5	APSSC-S05
SC-SC	10	APSSC-S10

## ECONOMY PIGTAILS

- Available in LC, SC, or ST connector styles
- Multimode, laser-optimized multimode, or single-mode fiber types
- 900 μm buffered fiber cable in 3-meter length, color white
- Application use: fusion or mechanical splicing
- 12-fiber color-coded pigtail kit, colors per ANSI/TIA-598-C

MULTIMODE PIGTAIL - SIMPLEX (3 METERS)	
DESCRIPTION	PART NO.
LC 62.5/125 μm, OM1	62PLC-M03
SC 62.5/125 μm, OM1	62PSC-M03
ST 62.5/125 μm, OM1	62PST-M03
LC 50/125 μm, OM2	50PLC-M03
SC 50/125 μm, OM2	50PSC-M03
ST 50/125 μm, OM2	50PST-M03
LC 50/125 μm, LOMM, OM3	5LPLC-M03
SC 50/125 μm, LOMM, OM3	5LPSC-M03
ST 50/125 μm, LOMM, OM3	5LPST-M03
LC 50/125, LOMM, OM4	54PLC-M03

12-FIBER INDIVIDUAL COLOR-CODED PIGTAIL KITS (3 METERS)	
LC 62.5/125 μm, OM1	62PLC-KIT
LC 50/125 μm, OM2	50PLC-KIT
LC 50/125 μm LOMM, OM3	5LPLC-KIT
LC 50/125 μm LOMM, OM4	54PLC-KIT
SC 62.5/125 μm, OM1	62PSC-KIT
SC 50/125 μm, OM2	50PSC-KIT
SC 50/125 μm LOMM, OM3	5LPSC-KIT
ST 62.5/125 μm, OM1	62PST-KIT
ST 50/125 μm, OM2	50PST-KIT
LC UPC Polish SM, OS2	UPPLC-KIT
SC UPC Polish SM, OS2	UPPSC-KIT

SINGLE-MODE PIGTAIL - SIMPLEX (3 METERS)	
LC UPC polish	UPPLC-S03
SC UPC polish	UPPSC-S03
ST UPC polish	UPPST-S03
LC APC polish	APPLC-S03
SC APC polish	APPSC-S03

Contact inside sales at 800.722.2082 for 6-fiber pigtail kits, other configurations, or custom lengths.

# PRE-TERMINATED CABLE ASSEMBLIES & PATCH CORDS | Secure Keyed LC Patch Cords & Pigtails



Secure Keyed LC to Secure Keyed LC, 50/125 μm LOMM



Single-Mode Pigtail SC UPC Polish

## SECURE KEYED LC PATCH CORDS & PIGTAILS

- Uniboot design prevents unauthorized and inadvertent moves, adds, and changes (MACs)
- Duplex LC connectors can only be removed with matching-color extraction tool
- Choose from eight colors to segregate and secure networks
- Duplex LC connector plugs into any industry-compliant LC adapter or interface
- All connectors are heat cured and use ceramic ferrules for optimal performance
- Polarity options of A to B or A to A



pre-terminated cable assemblies & patch cords

FIBER

## Make to order! SECURE KEYED LC FIBER PATCH CORD & PIGTAIL OPTIONS

KEYED COLOR	FIBER TYPE	CABLE TYPE / POLARITY	FIBER COUNT	TERMINATION	CABLE LENGTH (FEET)
<ul style="list-style-type: none"> <li>• White</li> <li>• Yellow</li> <li>• Orange</li> <li>• Red</li> <li>• Blue</li> <li>• Green</li> <li>• Slate</li> <li>• Black</li> </ul>	<ul style="list-style-type: none"> <li>• OM1</li> <li>• OM2</li> <li>• OM3</li> <li>• OM4 (aqua)</li> <li>• OM4 (violet)</li> <li>• OS2</li> </ul>	<ul style="list-style-type: none"> <li>• Duplex Riser-Rated A to B Polarity</li> <li>• Duplex Plenum-Rated A to B Polarity</li> <li>• Duplex Riser-Rated A to A Polarity</li> <li>• Duplex Plenum-Rated A to A Polarity</li> <li>• Pigtail Riser-Rated</li> </ul>	<ul style="list-style-type: none"> <li>• 12</li> <li>• 24</li> </ul>	<p><b>FIRST END</b></p> <ul style="list-style-type: none"> <li>• Keyed Duplex LC (uniboot)</li> </ul> <p><b>SECOND END</b></p> <ul style="list-style-type: none"> <li>• Keyed Duplex LC (uniboot)</li> <li>• Standard LC (duplex clips)</li> <li>• SC</li> <li>• ST</li> <li>• MU</li> <li>• MT-RJ</li> <li>• FC</li> <li>• None</li> </ul>	<ul style="list-style-type: none"> <li>• 1-999</li> </ul>

For assistance customizing your patch cords and pigtails, please visit [leviton.com/configurator](http://leviton.com/configurator) or call Tech Support at 800.824.3005.

## SPOTLIGHT

### Pulling Eye



Heavy-Duty High-Tensile Load Option  
Used for 125 Feet and More

The pulling eye protects fiber connectors on 12- through 144-fiber trunk cables. It completely covers the breakout length, transferring any pulling force from the assembly to the pulling eye sleeve. Customers can specify which end to have the pulling eye installed. Also available: a high-tensile load option that attaches to Kevlar®.

# FEATURES



## connectors & housings

Leviton has everything you need to properly terminate your fiber network. FastCAM® and Fast-Cure® connectors are available in LC, SC, and ST styles. Secure Keyed LC Field-Installable Connectors lock into any industry-compliant adapters and prevent unauthorized moves, adds, and changes (MACs). To extend fiber to the workstation, we also offer QuickPort® footprint fiber adapters that fit into our standard wallplates and Multimedia Outlet System (MOS) housings. See the Copper section for copper workstation connectivity products, including connectors and an extensive wallplate selection.

### FEATURED PRODUCTS

FastCAM®  
Connectors **B60**

Secure Keyed LC  
Connectors &  
Accessories **B62**





**FASTCAM CONNECTORS**

- Pre-polished, field-installable connectors
- Designed for data center and other applications that require fast network deployment
- Use precision zirconia ferrules
- Require no polishing or epoxy curing; provide immediate termination
- Precision mechanical termination uses molded v-groove technology to retain and align the fiber
- Terminated on 250 µm or 900 µm buffered fiber and/or 2 or 3 mm jacketed fiber
- Available in multimode, laser-optimized multimode, and single-mode connector styles
- Higher yields with Visual Fault Locator (VFL) compatible LC, SC, and ST connectors



connectors & housings

FIBER

FASTCAM CONNECTORS - 1 PER BAG				
DESCRIPTION	OS2 SINGLE-MODE	OM1 MULTIMODE	OM2 MULTIMODE	OM3 & OM4 LO MULTIMODE
<b>[A]</b> LC FastCAM Connector	49991-SLC (blue)	49991-MLC (beige)	49991-5LC (black)	49991-LLC (aqua)
<b>[B]</b> SC FastCAM Connector	49991-SSC (blue)	49991-MSC (beige)	49991-5SC (black)	49991-LSC (aqua)
<b>[C]</b> ST FastCAM Connector	49991-SST (blue)	49991-MST (beige)	49991-5ST (black)	—
FASTCAM ACCESSORIES				
FastCAM LC Duplex Clips <sup>^</sup>	49991-CLP	49991-CLP	49991-CLP	49991-CLP

<sup>^</sup> = Minimum order quantity and lead times may apply. See pages B69-B72 for FastCAM tools and consumables.

**SPOTLIGHT** Visual Fault Locator (VFL)



The Leviton Visual Fault Locator (VFL) uses a bright red laser to locate faults in optical fiber, such as bends, breaks, and defective connectors. Included with each VFL are a 2.5 mm ferrule interface, 1.25 mm adapter, and soft carrying case. Use with LC, SC, and ST FastCAM connectors.

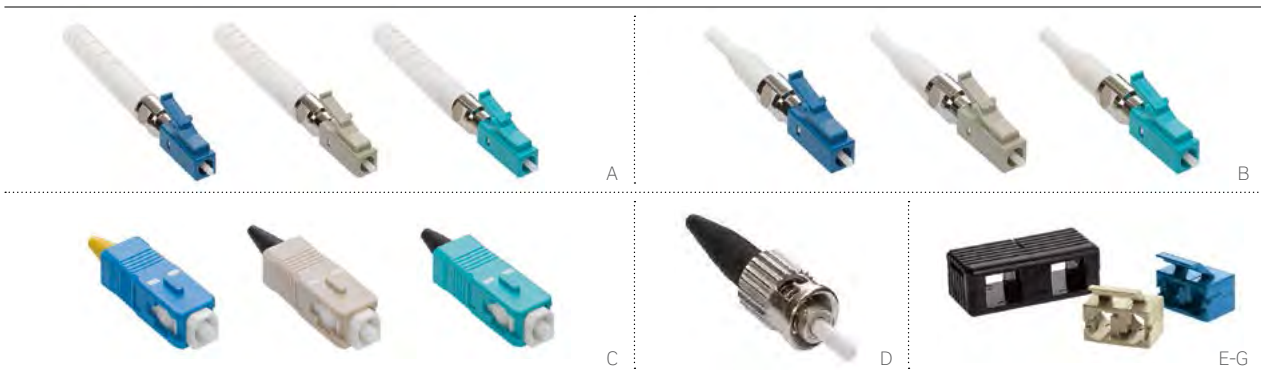

**FAST-CURE CONNECTORS**

- Anaerobic adhesive-style, field-installable connectors
- Hand polishing required
- Most robust connection, ideal for inside and outside plant applications
- Available in LC, SC, and ST connector styles
- Available in LOMM, multimode, and single-mode versions
- 900 µm and 3-mm boots included with SC and ST connectors



Fast-Cure Components

FAST-CURE ADHESIVE CONNECTORS			
DESCRIPTION	OS2 SINGLE-MODE	OM1 & OM2 MULTIMODE	OM3 & OM4 LO MULTIMODE
<b>[A]</b> LC Fast-Cure Connector with 2 and 3 mm boot	49990-SL2 (blue)	49990-ML2 (beige)	49990-LL2 (aqua)
<b>[B]</b> LC Fast-Cure Connector with 900 µm boot	49990-SDL (blue)	49990-MDL (beige)	49990-LDL (aqua)
<b>[C]</b> SC Fast-Cure Connector	49990-SSC (blue)	49990-MSC (beige)	49990-LSC (aqua)
<b>[D]</b> ST Fast-Cure Connector	49990-SST	49990-MST	—

  

FAST-CURE ACCESSORIES			
<b>[E]</b> LC Duplex Clip for Fast-Cure Connector, beige (bag of 25)	—	49886-DLM	49886-DLM
<b>[F]</b> LC Duplex Clip for Fast-Cure Connector, blue (bag of 25)	49886-DLS	—	—
<b>[G]</b> SC Duplex Clip for Fast-Cure Connector, black (bag of 25)	49886-DSC	49886-DSC	49886-DSC

See pages B69-B72 for Fast-Cure tools and consumables.

**SPOTLIGHT** Ceramic vs. Polymer Ferrules

**Fiber optic ferrules**, which ensure accurate alignment of fiber-to-fiber core interfaces, can be constructed of zirconia ceramic or polymer composites. While the two materials offer comparable performance in several areas, ceramic ferrules are superior in the key attributes of reliability (withstanding day-to-day environmental stressors) and durability (withstanding repeated matings/MACs). Leviton builds its connectors using only ceramic ferrules, so our customers can be assured of the best fiber connector performance in any application.

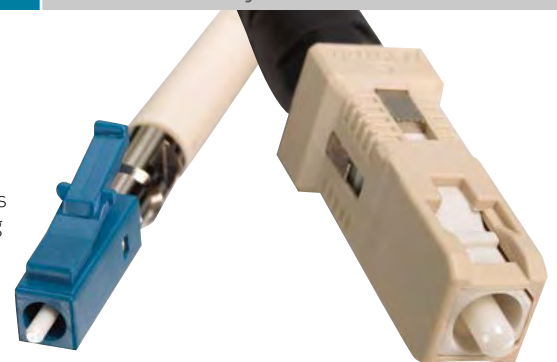

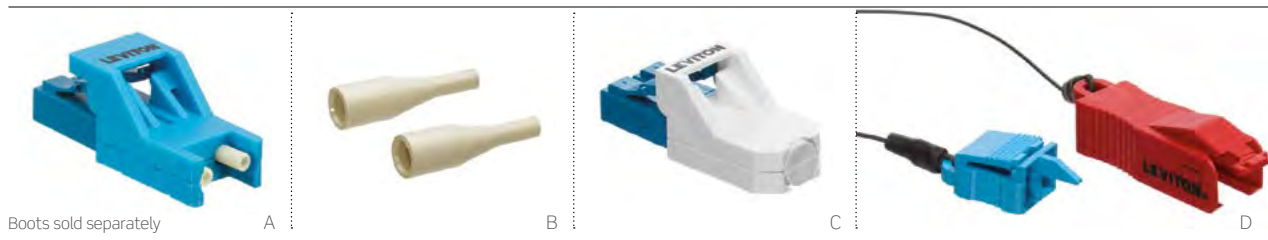

The Leviton Secure Keyed LC Fiber System prevents unauthorized and inadvertent changes in highly sensitive applications such as government and military networks, data centers and colocation equipment rooms, and financial, academic, and health care market sectors. Once connected to a port, the locking design - built into the body of each duplex LC connector - prevents removal by hand, and the connector can only be removed with a matching-color extraction tool.

## SECURE KEYED LC CONNECTORS & SYSTEM ACCESSORIES

- Field-installable duplex LC connectors lock into any industry-compliant LC adapter or interface
- Anaerobic adhesive-style, requires hand polishing (see page B70 for Polishing Tool Kit 49800-FTK)
- Connectors can only be removed with matching-color extraction tool
- Extraction tools allow for easy connector removal from adapter plates and wallplates
- 900 μm boots identify fiber type
- Port protection plugs enable unused LC ports to be locked
- Dust caps protect connectors upon removal from a port, promoting good fiber discipline

Secure Keyed LC system also includes trunk cables (B50), harnesses (B53), patch cords and pigtails (B58).

## SECURED KEYED LC ASSEMBLY VIDEO



Watch the training video at [leviton.com/videos](http://leviton.com/videos): "How to Assemble Leviton's Secure Keyed LC Connector Housing."

## SECURE KEYED LC FIELD-INSTALLABLE CONNECTORS

DESCRIPTION	PART NO.
<b>[A]</b> Secure Keyed LC Field-Installable Connector, 900 μm, MM/SM (boot sold separately)	4999K-xLC
<b>[B]</b> 900 μm Boots (bag of 50)	4999K-***

## SECURE KEYED LC ACCESSORIES

<b>[C]</b> Port Protection Plug w/ Dust Cap	PPRTN-xLG
<b>[D]</b> Extraction Tool w/ Dust Cap	ETRTN-xTL
Dust Caps (bag of 10)	DUSTK-CAP

x = colors: Choose from any of the colors below.



White (W) Yellow (Y) Orange (O) Red (R) Blue (L) Green (V) Slate (G) Black (E)

\*\*\* = Beige (BGE), Black (BLK), Aqua (AQU), Blue (BLU)

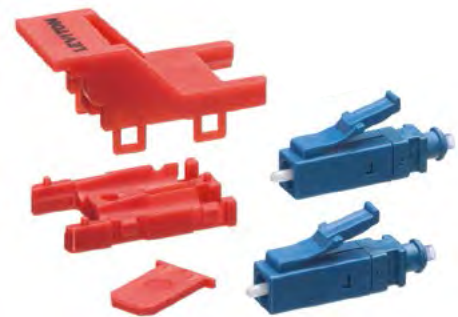

Field-Installable Duplex LC Connector Components

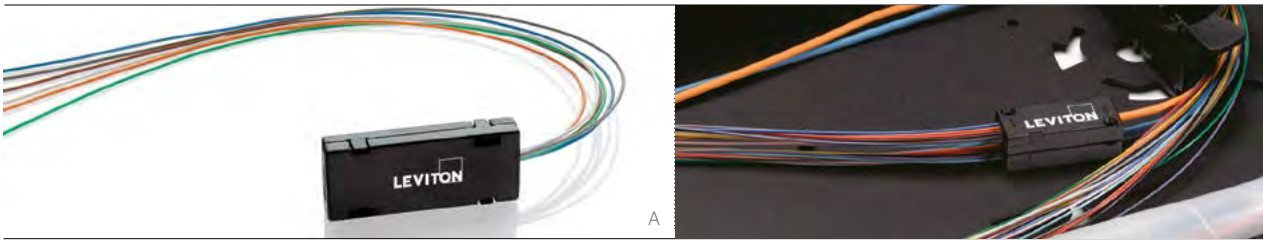

Stack multiple Fiber Optic Fan-Out Kits inside a fiber enclosure to save space. Available in two lengths, these 6- or 12-fiber kits separate 250  $\mu$ m fibers and route them into color-coded 900  $\mu$ m buffer tubes. The easy-to-use kits work with any manufacturer's loose-tube cabling and any industry-standard connectors.

### FIBER OPTIC FAN-OUT KITS

- Protect bare fiber and prepare loose-tube cable for direct termination to industry-standard connectors
- Separate 250  $\mu$ m fibers and route into color-coded 900  $\mu$ m buffer tubes with no proprietary tools
- Available in 6- or 12-strand kits and 24" or 36" lengths
- Works with cabling from any manufacturer (will accommodate buffer-tube diameter up to 3.5 mm max)

FIBER OPTIC FAN-OUT KITS	
DESCRIPTION	PART NO.
[A] 24" Fiber Optic Fan-Out Kit, 6 fiber	49887-06S
24" Fiber Optic Fan-Out Kit, 12 fiber	49887-12S
36" Fiber Optic Fan-Out Kit, 6 fiber	49887-06L
36" Fiber Optic Fan-Out Kit, 12 fiber	49887-12L
Fan-Out Consumables Kit	49800-FAN

### FAN-OUT KIT TERMINATION VIDEO



To learn more, watch a termination demonstration at [leviton.com/videos](http://leviton.com/videos).

# CONNECTORS & HOUSINGS | QuickPort® Adapters



connectors & housings

**FIBER**

## QUICKPORT FIBER ADAPTERS

- Snap into all QuickPort openings and Multimedia Outlet System (MOS) housings
- Tool-free plug-n-play installation
- Offered with precision phosphor bronze or zirconia ceramic alignment sleeve

### QUICKPORT FIBER ADAPTERS ^

DESCRIPTION	PART NO.
<b>[A]</b> QuickPort Duplex LC Adapter, MM, phosphor bronze sleeve, beige	41085-ML°
<b>[B]</b> QuickPort Duplex LC Adapter, 10G LOMM, zirconia ceramic sleeve, aqua	41085-LL°
<b>[C]</b> QuickPort Duplex LC Adapter, SM, zirconia ceramic sleeve, blue	41085-SL°
<b>[D]</b> QuickPort Simplex SC Adapter, MM, phosphor bronze sleeve, female front/back	41085-M*C
QuickPort Simplex SC Adapter, SM, zirconia ceramic, female front/back	41085-S*C
<b>[E]</b> QuickPort ST Fiber Optic Adapter, MM, phosphor bronze sleeve	41084-S*F
QuickPort ST Fiber Optic Adapter, SM, zirconia ceramic sleeve	41084-S*Z
<b>[F]</b> MTP® QuickPort Adapter, SM/MM	41085-TP*

^ = Minimum order quantity and lead times may apply.  
 \* = Colors: Choose from any of the colors below.

Some adapters are Make-to-Order, contact Inside Sales at 800.824.3005 for ordering information.  
 ° = Colors: Choose from any of the colors below.

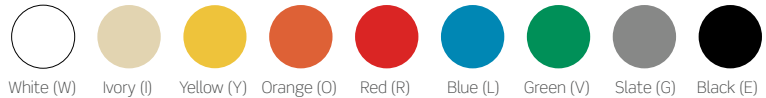

## SPOTLIGHT QuickPort Wallplates



QuickPort adapters are designed to fit our complete line of QuickPort wallplates found on pages A48-A54.

# CONNECTORS & HOUSINGS | Multimedia Outlet System (MOS)



The innovative Multimedia Outlet System (MOS) consists of a surface-mount box and single- and dual-gang wallplates that accept a wide variety of fiber, copper, and A/V connectors. The single-gang wallplate and surface-mount box accepts up to six connectors; dual-gang accepts up to twelve.

## FIBER INSERTS FEATURES

- Modules are available in 0.5, 1, 1.5, 2, and 3-unit-high sizes
- Surface-mount box accepts only 1-unit-high modules
- Plates accept 3 units high total
- Available in standard QuickPort® footprint as well as more specialized modules
- Snap-in installation into wallplates and surface-mount boxes
- Front-load installation simplifies moves, adds, and changes (MACs)
- Angled geometry protects cabling

See pages A45-A46 for copper and A/V MOS products.



A



B



C



D



E

## MOS SURFACE-MOUNT BOX AND WALLPLATE HOUSINGS

DESCRIPTION	WHITE	LT. ALMOND	IVORY	GREY	BLACK
<b>[A]</b> Single-Gang Wallplate	41290-SMW	41290-SMT	41290-SMI	41290-SMG	41290-SME
<b>[B]</b> Dual-Gang Wallplate	41290-DMW	41290-DMT	41290-DMI	41290-DMG	41290-DME
<b>[C]</b> Surface-Mount Box	41296-MMW	41296-MMT	41296-MMI	41296-MMG	41296-MME
<b>[D]</b> Fiber Storage/Spacer Ring	41290-DRW	—	41290-DRI	41290-DRG	41290-DRE
<b>[E]</b> Decora® Insert, holds one 1-unit-high MOS module	41649-00W	—	41649-00I	—	—

See color swatches on page B66.

# CONNECTORS & HOUSINGS | Multimedia Outlet System (MOS)



MOS FIBER INSERTS					
DESCRIPTION	WHITE	IVORY	GREY	BLACK	
<b>[A]</b> 1 Duplex SC, zirconia ceramic, SM/MM blue, (1 unit high)	41291-2CW	41291-2CI	41291-2CG	41291-2CE	
<b>[B]</b> 1 Duplex SC, zirconia ceramic, SM/MM blue, 45° exit (1.5 units high)	41294-2CW	41294-2CI	41294-2CG	41294-2CE	
<b>[C]</b> 1 Duplex SC, zirconia ceramic, SM/MM blue, 45° exit (2 units high)	41292-2CW	41292-2CI	41292-2CG	41292-2CE	
<b>[D]</b> 2 Duplex SC, zirconia ceramic, SM/MM blue, 45° exit (3 units high)	41293-4CW	41293-4CI	41293-4CG	41293-4CE	
1 Duplex ST, zirconia ceramic, SM, (1 unit high)	41291-ZTW	41291-ZTI	41291-ZTG	41291-ZTE	
<b>[E]</b> 1 Duplex ST, phosphor bronze, MM, (1 unit high)	41291-2TW	41291-2TI	41291-2TG	41291-2TE	
1 Duplex ST, zirconia ceramic, SM, 45° exit (1.5 units high)	41294-ZTW	41294-ZTI	41294-ZTG	41294-ZTE	

For multimode SC adapters in beige, blue, or aqua housing, please contact inside sales at 800.722.2082.

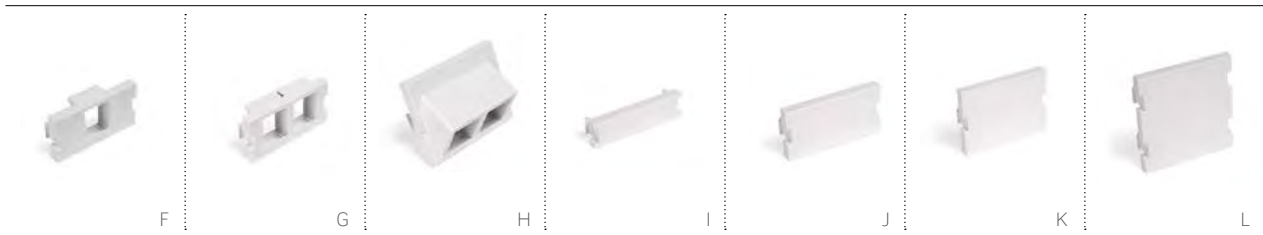

MOS QUICKPORT® ADAPTERS & BLANK MODULES					
DESCRIPTION	WHITE	LT. ALMOND	IVORY	GREY	BLACK
<b>[F]</b> 1-Port QuickPort Module (1 unit high)	41291-1MW	41291-1MT	41291-1MI	41291-1MG	41291-1ME
<b>[G]</b> 2-Port QuickPort Module (1 unit high)	41291-2QW	41291-2QT	41291-2QI	41291-2QG	41291-2QE
<b>[H]</b> 2-Port 45° Exit Angled QuickPort Module (1.5 units high)	41294-2QW	41294-2QT	41294-2QI	41294-2QG	41294-2QE
<b>[I]</b> Blank Module (0.5 unit high)	41295-5BW	41295-5BT	41295-5BI	41295-5BG	41295-5BE
<b>[J]</b> Blank Module (1 unit high)	41291-1BW	41291-1BT	41291-1BI	41291-1BG	41291-1BE
<b>[K]</b> Blank Module (1.5 units high)	41294-2BW	41294-2BT	41294-2BI	41294-2BG	41294-2BE
<b>[L]</b> Blank Module (2 units high)	41292-2BW	41292-2BT	41292-2BI	41292-2BG	41292-2BE

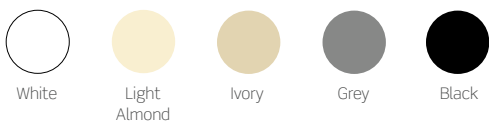

For LC adapters, use QuickPort modules above and LC adapters on page B64.

# FERB



## FEATURED PRODUCTS

Visual Fault Locator (VFL) **B71**

LYNX Cleaver **B71**

## tools & consumables

Different termination types require unique tools. Leviton has everything you need to terminate Fast-Cure® (adhesive polish) and FastCAM® (pre-polished) connectors. We also offer cleaning tools for LC, SC, and MTP® connectors. Choose from complete kits, or mix and match individual tools and a wide variety of consumables.



## VISUAL FAULT LOCATOR (VFL)

Quickly locate optical fiber damage with the Leviton Visual Fault Locator (VFL). The pocket-sized tool uses a bright red laser to locate faults, including tight bends, breaks, and defective connectors. Included with each VFL are a 2.5 mm ferrule interface, 1.25 mm adapter, and soft carrying case. Use with FastCAM® LC and SC connectors for enhanced terminations. See page B71 for part numbers.



tools & consumables

FIBER

## LEVITON 200X INSPECTION SCOPES

Reduce the chances of over-polishing with Leviton's high-powered inspection scopes. View single-mode and multimode end-face polishes safely with our oblique viewing technology; full laser eye protection is provided through wavelengths of 850 - 1550 nanometers (nm). Rugged metal and rubber construction stands up to job-site abuse while offering an ergonomic grip. See page B71.



## FASTCAM TERMINATION TOOLS

FastCAM terminations and fusion splicing both require precision cleaving. Get the accuracy you need with the LYNX Cleaver. A cleave angle of 90° +/- .5° is guaranteed; the 16-position blade remains sharp through approximately 48,000 cleaves. Clean-up is eliminated with the built-in waste holder. For a self-contained workspace, mount the LYNX to the optional work tray and use the gooseneck LED for task lighting. See page B71.



## ONLINE TRAINING VIDEOS & ANIMATIONS

Increase your expertise with Leviton's online fiber training. Animated, step-by-step instructions on terminating FastCAM 250 μm or 900 μm fiber, using our fan-out kits, or terminating Fast-Cure® connectors, are all available with just a click of the mouse. All of Leviton's training animations feature clear, easy-to-understand graphics paired with on-screen written instructions for maximum effectiveness. Visit [leviton.com/support](http://leviton.com/support).





A



B



C

## FIBER OPTIC LIGHT TOOL KIT

- Essential tool set for quick field-termination of Fast-Cure® connectors
- Terminates both multimode and single-mode fiber

## FIBER OPTIC FAST-CURE TOOL KIT

- All the tools you need for terminating multimode or single-mode LC, SC, or ST Fast-Cure adhesive connectors
- Adhesive/accelerator kit sold separately, see page B72

## FIBER OPTIC FASTCAM® TOOL KIT

- Precision cleaving for guaranteed FastCAM connector performance
- Terminates both multimode and single-mode fiber

Consumables sold separately, see page B72.

# TOOLS & CONSUMABLES | Fiber Optic Tool Kits

FIBER OPTIC TOOL KITS CONTENTS	LIGHT TOOL KIT 49800-MTK	FAST-CURE® TOOL KIT 49800-FTK	FASTCAM® TOOL KIT 49800-MSK
Standard Tool Kit Carrying Case	•		
250 µm Buffer Remover		•	
900 µm Buffer Remover	•	•	•
Jacket Stripper	•	•	
Aramid Strand Scissors	•	•	
Safety Glasses		•	
Sapphire Scribe	•	•	
2.5 mm Polishing Puck	•	•	
3" x 6" Polishing Pad	•	•	
ST/SC Combination Tightening Tool	•		
Versa-Cleave® Tool			
LYNX Cleaver			•
100x Inspection Scope	•		
200x Inspection Scope		•	
Piano Wire		•	
Lint-Free Dry Wipes		•	•
Alcohol Pads		•	•
12 µm Aluminum-Oxide Lapping Film		•	
3 µm Aluminum-Oxide Lapping Film		•	
0.3 µm Aluminum-Oxide Lapping Film		•	
Crimp Tool		•	
LC Scope Adapter		•	
LC Polishing Puck		•	

## FIBER OPTIC TOOL KITS

DESCRIPTION	PART NO.
<b>[A]</b> Light Tool Kit	49800-MTK
<b>[B]</b> Fast-Cure Tool Kit	49800-FTK
<b>[C]</b> FastCAM Tool Kit w/ LYNX Cleaver <sup>^</sup>	49800-MSK
FastCAM Tool Kit w/ LYNX Cleaver, work tray, and LED light <sup>^</sup>	49800-LAK
FastCAM Tool Kit w/ CT-30A Cleaver (cleaver shown on page B71)	49800-SMK

<sup>^</sup> = Minimum order quantity and lead times may apply.  
Individual consumables available on page B72.  
Note: Adhesive/accelerator tool kit sold separately. See page B72.

# TOOLS & CONSUMABLES | Fiber Optic Tools

tools & consumables

FIBER

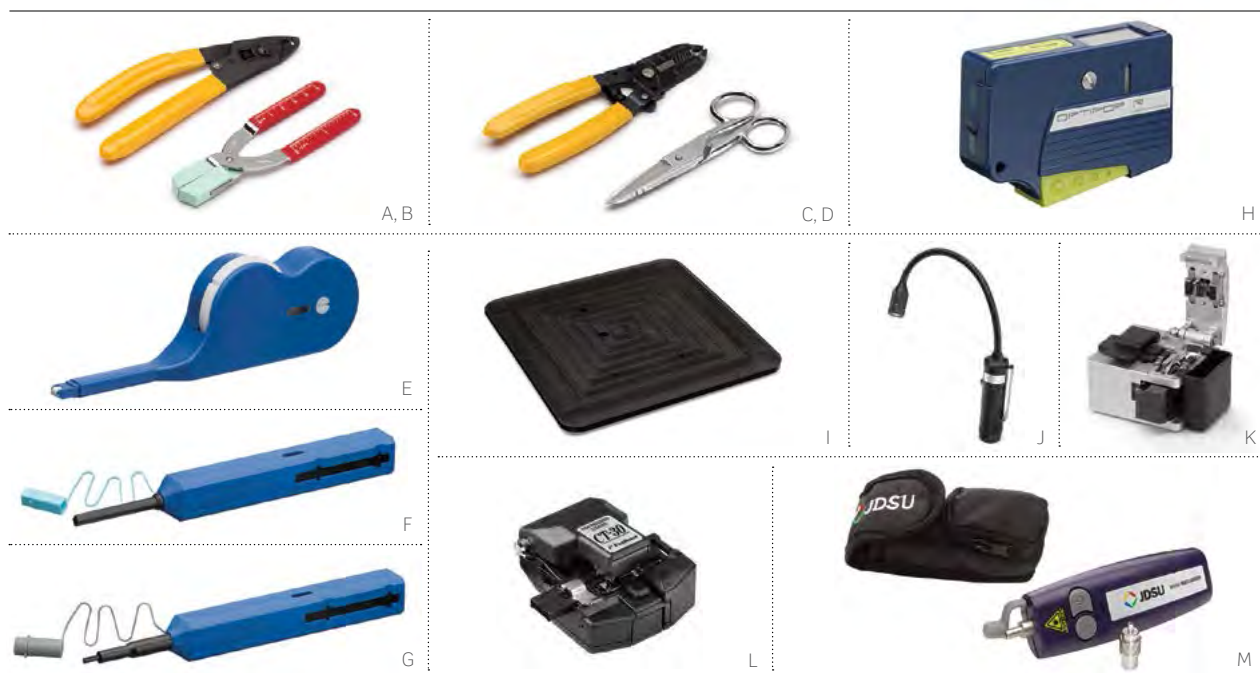

UNIVERSAL TOOLS & ACCESSORIES	
DESCRIPTION	PART NO.
[A] 250 and 900 μm Buffer Remover (yellow handle)	49886-BR2
[B] 900 μm Buffer Remover (red handle)	49886-BR9
[C] Jacket Stripper	49886-STP
[D] Aramid Strand Scissors	49886-SIS
Marking Pen	49886-SMP
Safety Glasses	49886-GLS
Sapphire Scribe	49886-SCR
1.25 mm (LC) Polishing Puck	49886-LCP
2.5 mm (SC/ST) Polishing Puck	49886-PUC
3" x 6" Polishing Pad	49886-PAD
Opt-X® Tool Kit Carrying Case	49886-CSE
Safety Pad	49886-SPD
200x Inspection Scope	49886-FSP
LC Scope Adapter (works w/ 200x scope only)	49886-LCS
Duplex LC Scope Adapter (works w/ 200x scope only)	49886-LCD
MTP® Scope Adapter (works w/ 200x scope only)	49886-MCS
Fiber Optic Crimp Tool with .128/.151/.178 hex die	49886-FCT
Tool Kit Carrying Case	49886-FCC
[E] MTP Cassette Cleaning Tool	49886-MCT
MTP Cassette Cleaning Tool Refill (male)	49886-MCR
[F] LC Connector Cleaning Tool	49886-LCT
[G] SC Connector Cleaning Tool	49886-SCT
[H] MTP Connector Cleaning Tool (female)	49886-UFT
MTP Connector Cleaning Tool (male)	49886-UMT

FASTCAM® SPECIFIC TOOLS	
[I] Work Tray^	49886-LNT
[J] Gooseneck LED^	49886-LGN
[K] LYNX Cleaver^	49886-LNX
[L] Fujikura CT-30A Cleaver^	49886-CTA
[M] Visual Fault Locator (VFL) (2.5 and 1.25 mm adapters included)	49886-VFL
Replacement 1.25 mm Adapter for VFL	49886-FLA

^ = Minimum order quantity and lead times may apply.



## UNIVERSAL CONSUMABLES KIT

All the basic supplies needed to clean and polish fiber optic connectors. Set includes:

- 50 lint-free dry wipes
- 50 alcohol pads
- 30 sheets 12 µm lapping film
- 30 sheets 3 µm lapping film
- 30 sheets 0.3 µm lapping film
- Piano wire

## ADHESIVE/ACCELERATOR KIT

Set includes:

- Loctite 680 adhesive
- Loctite 7649 accelerator with syringe
- Two needles
- Will do approximately 200 terminations

## FAST-CURE® CONSUMABLES KIT

Everything from the Universal Kit, plus specialized supplies for Fast-Cure terminations. Additional included items:

- 25 syringes
- 25 needles
- Adhesive and accelerator
- Will do approximately 200 terminations

## FAN-OUT CONSUMABLES KIT

Kit terminates a minimum of 10 Fiber Optic Fan-Out Kits. Set includes:

- 20 lint-free dry wipes
- 10 alcohol pads
- 10 D'Gel® packets
- Sealant
- Talc powder

### CONSUMABLES KITS

DESCRIPTION	PART NO.
<b>[A]</b> Universal Consumables Kit	49800-CON
<b>[B]</b> Fast-Cure Consumables Kit	49800-FCC
<b>[C]</b> Adhesive/Accelerator Kit	49800-680
<b>[D]</b> Fan-Out Consumables Kit	49800-FAN

### CONSUMABLES

Piano Wire	49886-WRE
Lint-Free Dry Wipes (100 per pack)	49886-DWP
Alcohol Pads (100 per pack)	49886-APD
12 µm Aluminum-Oxide Lapping Film, pink (100 per pack)	49886-12F
3 µm Aluminum-Oxide Lapping Film, yellow (100 per pack)	49886-03F
0.3 µm Aluminum-Oxide Lapping Film, light blue (100 per pack)	49886-X3F
Replacement Needles (25 per pack)	49886-FCN
Replacement Syringes (25 per pack)	49886-SYR



# CABLE MANAGEMENT



SECTION

C

---

## SECTION C CONTENTS

- C3** Overhead Infrastructure Platform
- C5** Fiber Raceway System
- C13** Versi-Duct® Cable Management System
- C15** Horizontal Cable Managers
- C16** Rear Cable Managers
- C17** Blanks & Transitional Covers
- C18** Rings & Brackets
- C19** VELCRO® Brand Fasteners
- C21** Zone Enclosures
- C22** Wireless Access Point Enclosures



## OVERHEAD INFRASTRUCTURE PLATFORM

The Overhead Infrastructure Platform provides independent support for cabling pathways, power, lighting, and other infrastructure. Platforms can carry the load of cables and ladder trays while freeing up rack space by adding patching above cabinets or racks. Since cabinets and racks are not attached, power and cabling can be quickly disconnected without removing hardware.

### INCREASED FLEXIBILITY & ACCESS IN OVERHEAD SPACES

In many data centers, access to the ceiling may be limited, or the roof structure may not allow the added weight from cables and ladder trays. The floor-mounted Overhead Infrastructure Platform can carry the load and avoid obstructions while freeing up rack space by adding patching above cabinets or racks.

### TIME & LABOR SAVINGS

Installing overhead-suspended ladder trays from tall ceilings is cumbersome and time consuming. When ladder trays and wiring baskets are hung from the ceiling it is necessary to “thread” the cable and trunks through ceiling supports, requiring additional labor at the time of initial installation. Using the Overhead Infrastructure Platform can reduce installation time by 40% in a typical installation.

### FEATURES

- Works with any cabinet, cable tray, ladder, or raceway, including Leviton’s Fiber Raceway System
- Scalable for growth: allows expansion without disruption of current operations
- System accessories require no rack unit space
- Allows unobstructed access to overhead cabling
- Faster deployment, decommissioning, or replacement of server cabinets
- Reduced installation costs and fewer on-site problems
- Complies with TIA-569, cULus Listed, and meets ANSI STANDARD T1.336-2003 Tier 1 Universal Telecom Framework
- Includes industry-compliant bonding and grounding points

OVERHEAD INFRASTRUCTURE PLATFORM (CALL INSIDE SALES FOR ORDERING ASSISTANCE)			
DESCRIPTION	36" WIDE	42" WIDE	48" WIDE
Overhead Infrastructure Platform, 96" H	OIPFR-36A	OIPFR-42A	OIPFR-48A
Overhead Infrastructure Platform, 108" H	OIPFR-36B	OIPFR-42B	OIPFR-48B
Overhead Infrastructure Platform, 120" H	OIPFR-36C	OIPFR-42C	OIPFR-48C





## RAPID SWAP-OUT & STAGING

Racks and cabinets are not attached to basket trays and other overhead cable management, allowing power and cabling to be quickly disconnected from the cabinet without removing hardware. Connections within the cabinet can be easily disconnected, making room for new equipment to be rolled in with minimal interruption.

## ACCESSORIES

- **Frame Drill Template** - used to lay out Overhead Infrastructure Platform frame mounting locations
- **Channel Attachment Bracket Kit** - Left/Right brackets mount to standard steel channel framing to span the platform
- **Sub-Floor Mounting Kit** - plate for bottom of a raised floor tile that accepts standard threaded rod
- **C-Brackets** - creates a two-tier mounting surface for ladder trays or wire baskets; available in a variety of sizes
- **Patch Panel Bracket** - mounted on the steel channel above the cabinet and accepts standard 19" patch panels or other fiber enclosures, providing up to 4RU of additional patching capability

### OVERHEAD INFRASTRUCTURE PLATFORM ACCESSORIES (CALL INSIDE SALES FOR ORDERING ASSISTANCE)

DESCRIPTION	PART NO.	DESCRIPTION	PART NO.
6/6" Frame Extension Mounting C-Bracket	OIP06-06C	20/18" Frame Extension Mounting C-Bracket	OIP20-18C
8/8" Frame Extension Mounting C-Bracket	OIP08-08C	24/12" Frame Extension Mounting C-Bracket	OIP24-12C
12/8" Frame Extension Mounting C-Bracket	OIP12-08C	24/20" Frame Extension Mounting C-Bracket	OIP24-20C
20/8" Frame Extension Mounting C-Bracket	OIP20-08C	30/24" Frame Extension Mounting C-Bracket	OIP30-24C
36" Frame Drill Template	OIPDT-36W	Channel Attachment Bracket Kit (2 included)	OIPFR-CAB
42" Frame Drill Template	OIPDT-42W	Sub-Floor Mounting Kit (2 included)	OIPAC-SFM
48" Frame Drill Template	OIPDT-48W	Patch Panel Bracket	OIPAC-PPB

Please contact inside sales at 800.722.2082 for more information.  
For assembly and floor mounting instructions, go to [leviton.com/OIP](http://leviton.com/OIP).



### FIBER RACEWAY SYSTEM

Route, protect, and store fiber cabling with the Leviton Fiber Raceway System. The easy to design, easy to configure, easy to install cable management system provides a dedicated path for critical network cabling. Fiber Raceway is an ideal solution in data centers, telecom rooms, and wiring closets - virtually any application that requires fiber cable protection or segregation.

fiber raceway

CABLE MANAGEMENT

### ADAPTS TO ANY APPLICATION

Raceway components are available in three colors (yellow is standard; orange and black are special order), four standard sizes, and a wide variety of styles. Ducting is available solid or slotted, with or without covers; connecting components enable drop-offs and routing around obstacles. Mounting kits allow overhead, raised-floor, and vertical installation.

### ASSEMBLES QUICKLY AND EASILY

Ducting is easily cut to size with a mitre saw, and the system installs with only a screwdriver and other simple carpentry tools. Connection components, including vertical and horizontal outlets and hardware-free covers, snap together tool free, saving time and money. Side drop-off kits can be added after initial installation anywhere along the Raceway to accommodate new cable routing to racks and cabinets.

### PRESERVES FIBER INTEGRITY

High-impact thermoplastic construction ensures ample protection, rigidity, and support. Ducting won't sag under heavy cable loads, and accidental cable damage is prevented, minimizing network downtime. Plus, the system maintains a minimum bend radius of 30 mm at all times.

### REDUCES FIRE DAMAGE

The Fiber Raceway System is UL 2024A listed for riser-rated telecommunications applications. In addition, raceway materials carry one of UL's highest flammability ratings, 94 V-0. They are also halogen-free and produce no corrosive acid or toxic gas emissions in the event of fire, making them ideal for sensitive environments from hospitals and nursing homes to telecom rooms and data centers.

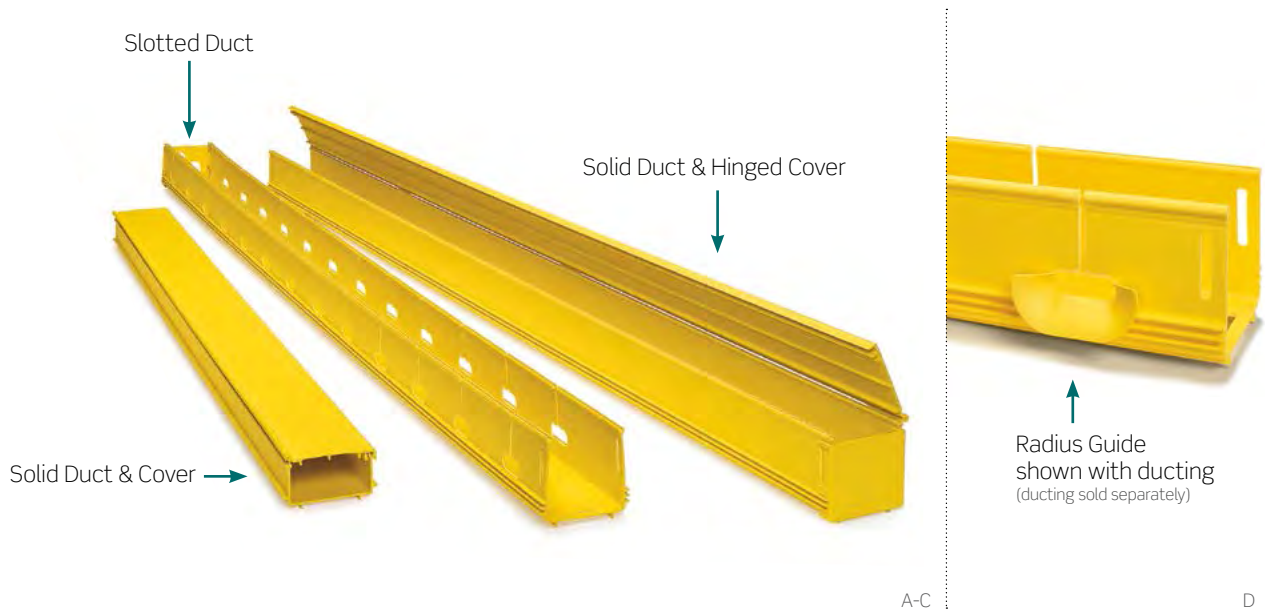

## DUCTING & BEND RADIUS GUIDES

- Ducting is ideal for routing and supporting cables throughout fiber networks
- 6.5-foot sections can be hand cut to fit exact specifications
- Available in four sizes with two cover types or without covers
- Slotted ducting is ideal for cable runs with varying exit locations
- Bend radius guides safely route fiber
- Available in yellow as a standard color; special order colors available in orange and black

DUCTING				
DESCRIPTION	2" X 2"	4" X 4"	4" X 8"	4" X 12"
Solid Duct	S2DCT-SDT	S4DCT-SDT	S8DCT-SDT	SWDCT-SDT
<b>[A]</b> Solid Duct and Cover	S2DCT-SDC	S4DCT-SDC	S8DCT-SDC	SWDCT-SDC
<b>[B]</b> Slotted Duct	S2DCT-DSL	S4DCT-DSL	—	—
<b>[C]</b> Solid Duct and Hinged Cover	S2DCT-DHC†	S4DCT-DHC	S8DCT-DHC	—
Slotted Duct and Cover	S2DCT-DCS	S4DCT-DCS	—	—
Slotted Duct and Hinged Cover	—	S4DCT-SHC	—	—

BEND RADIUS GUIDES	
DESCRIPTION	PART NO.
<b>[D]</b> Radius Guide (10 pack) (fits 2" x 2" and 4" x 4" slotted ducts)	SRAGD-SLT

Dimensions listed as H x W.  
 † = 2" x 2" hinged cover is available in eight 10" sections only.  
 2" x 4" and 2" x 8" ducting available by special order.  
 Color: Yellow is standard. Orange and Black are special order and require additional lead time.



Please contact inside sales at 800.722.2082 to order or for more information.

# CABLE MANAGEMENT | Fiber Raceway System

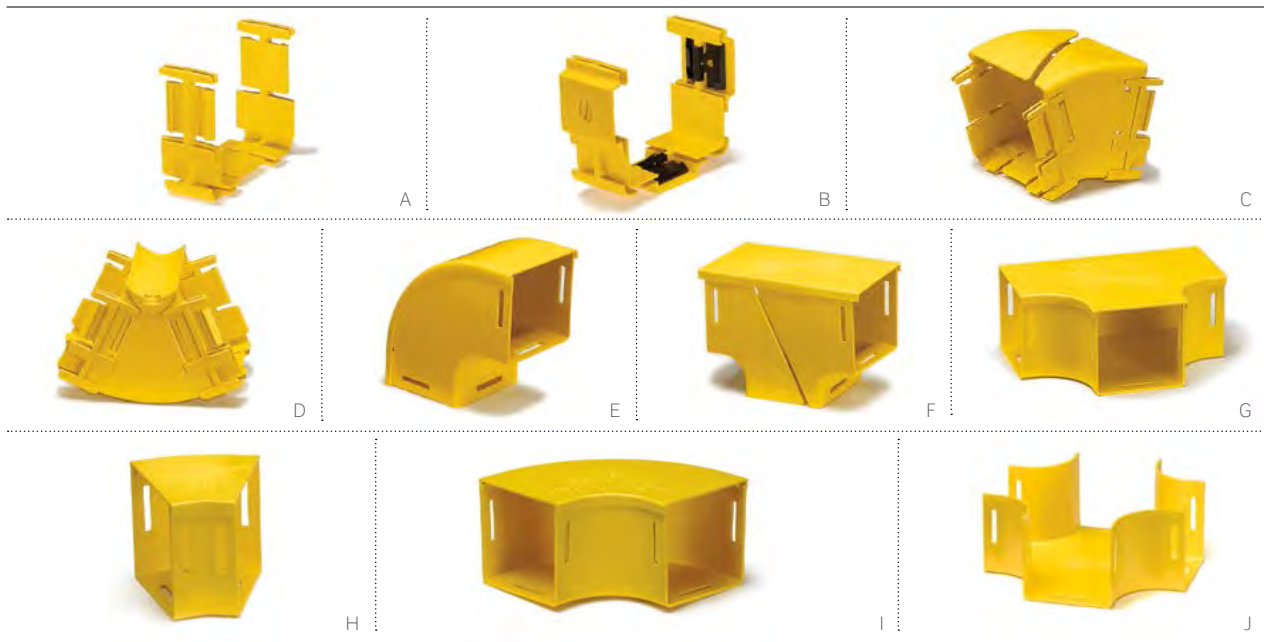

fiber raceway

CABLE MANAGEMENT

## JOINERS

- Joiners create a rigid connection between ducting sections and other components
- Standard Joiners install without tools; Slotless Joiners install using a screwdriver

## VERTICAL ELBOWS

- Connect horizontal raceway at different heights and route raceway around obstacles
- Available in four sizes, three angles, and with or without covers
- Retrofit styles allow easy addition of new fibers

## VERTICAL TEES

- Drop cables vertically from horizontal routes into frames or cabinets
- Available in four sizes with or without covers

## HORIZONTAL TEES

- Branch off the duct and extend the fiber route
- Available in four sizes with or without covers

## HORIZONTAL ELBOWS

- Change the direction of horizontal routes
- Available in four sizes, three angles, and with or without covers

## HORIZONTAL CROSSES

- Allow easy fiber routing in all directions for increased expansion and adaptability
- Available in four sizes with or without covers

Please contact inside sales at 800.722.2082 to order or for more information.

## SPOTLIGHT Fiber Raceway Application Notes



Leviton offers downloadable **Fiber Raceway** resources, including application notes, Visio® stencils, and a training video, available at [leviton.com/frs](http://leviton.com/frs). The application notes explain which raceway products or kits are appropriate for specific scenarios, from under-floor mounting to ladder and strut mounting. The video provides installation instructions and a component overview.

Design and product assistance is available via the Tech Support line at 800.824.3005 or at [appeng@leviton.com](mailto:appeng@leviton.com).

# CABLE MANAGEMENT | Fiber Raceway System

JOINERS				
DESCRIPTION	2" X 2"	4" X 4"	4" X 8"	4" X 12"
<b>[A]</b> Standard Joiner	S2JNR-SLT	S4JNR-SLT	S8JNR-SLT	—
<b>[B]</b> Slotless Joiner	—	S4JNR-SLS	S8JNR-SLS	SWJNR-SLS
VERTICAL ELBOWS				
Vertical Elbow 30° Down	S2VEL-30D	S4VEL-30D	S8VEL-30D	—
Vertical Elbow 30° Down and Cover	S2VEL-3DC	S4VEL-3DC	S8VEL-3DC	—
<b>[C]</b> Vertical Elbow 30° Down Retrofit	—	S4VEL-3DR	S8VEL-3DR	—
Vertical Elbow 30° Up	—	S4VEL-30U	S8VEL-30U	—
<b>[D]</b> Vertical Elbow 30° Up and Cover	—	S4VEL-3UC	S8VEL-3UC	—
Vertical Elbow 30° Up Retrofit	—	S4VEL-3UR	S8VEL-3UR	—
Vertical Elbow 45° Down	S2VEL-45D	S4VEL-45D	S8VEL-45D	SWVEL-45D
Vertical Elbow 45° Down and Cover	S2VEL-4DC	S4VEL-4DC	S8VEL-4DC	SWVEL-4DC
Vertical Elbow 45° Down Retrofit	—	S4VEL-4DR	S8VEL-4DR	—
Vertical Elbow 45° Up	—	S4VEL-45U	—	SWVEL-45U
Vertical Elbow 45° Up and Cover	S2VEL-4UC	S4VEL-4UC	S8VEL-4UC	SWVEL-4UC
Vertical Elbow 45° Up Retrofit	—	S4VEL-4UR	S8VEL-4UR	—
Vertical Elbow 90° Down	S2VEL-90D	S4VEL-90D	S8VEL-90D	SWVEL-90D
<b>[E]</b> Vertical Elbow 90° Down and Cover	S2VEL-9DC	S4VEL-9DC	S8VEL-9DC	SWVEL-9DC
Vertical Elbow 90° Down Retrofit	—	S4VEL-9DR	S8VEL-9DR	—
Vertical Elbow 90° Up	S2VEL-90U	S4VEL-90U	S8VEL-90U	SWVEL-90U
Vertical Elbow 90° Up and Cover	S2VEL-9UC	S4VEL-9UC	S8VEL-9UC	SWVEL-9UC
Vertical Elbow 90° Up Retrofit	S2VEL-9UR	S4VEL-9UR	S8VEL-9UR	—
Vertical Elbow 90° Up and Down Enclosed	—	S4VEL-9UD	S8VEL-9UD	—
VERTICAL TEES				
Vertical Tee	S2VTE-TEE	S4VTE-TEE	S8VTE-TEE	SWVTE-TEE
Vertical Tee and Cover	S2VTE-TEC	S4VTE-TEC	S8VTE-TEC	SWVTE-TEC
<b>[F]</b> Vertical Tee Retrofit	S2VTE-TER	S4VTE-TER	S8VTE-TER	—
HORIZONTAL TEES				
Horizontal Tee	S2HTE-TEE	S4HTE-TEE	S8HTE-TEE	SWHTE-TEE
<b>[G]</b> Horizontal Tee and Cover	S2HTE-TEC	S4HTE-TEC	S8HTE-TEC	SWHTE-TEC
HORIZONTAL ELBOWS				
Horizontal Elbow 30°	S2HEL-30D	S4HEL-30D	S8HEL-30D	—
<b>[H]</b> Horizontal Elbow 30° and Cover	S2HEL-3DC	S4HEL-3DC	S8HEL-3DC	—
Horizontal Elbow 45°	S2HEL-45D	S4HEL-45D	S8HEL-45D	SWHEL-45D
Horizontal Elbow 45° and Cover	S2HEL-4DC	S4HEL-4DC	S8HEL-4DC	SWHEL-4DC
Horizontal Elbow 90°	S2HEL-90D	S4HEL-90D	S8HEL-90D	—
<b>[I]</b> Horizontal Elbow 90° and Cover	S2HEL-9DC	S4HEL-9DC	S8HEL-9DC	SWHEL-9DC
HORIZONTAL CROSSES				
<b>[J]</b> Horizontal Cross	S2HCR-HCR	S4HCR-HCR	S8HCR-HCR	SWHCR-HCR
Horizontal Cross and Cover	S2HCR-HCC	S4HCR-HCC	S8HCR-HCC	SWHCR-HCC

Dimensions listed as H x W.  
 2" x 4" and 2" x 8" components available by special order.  
 2" x 2" offered in yellow only.  
 Color: Yellow is standard. Orange and Black are special order and require additional lead time.





fiber raceway

CABLE MANAGEMENT

## STORAGE LOOPS

- Organize excess patch cord lengths
- Available in two styles: inline for storing within the duct system, and offset for outside the main duct

## SIDE DROP-OFF KITS

- Provide a safe exit for fiber cords at any point along ducting when dropping down to active equipment or work areas

## END CAPS

- Snap into place to seal the open end of standard ducting; can easily be removed for future system modifications
- Available in two styles: solid-walled, or with knockouts for flexible tubing or fiber feedout

## REDUCERS

- Join varying ducting sizes together

## ADAPTERS

- Used to connect Leviton Fiber Raceway System with ADC ducting

## TUBING

- Manage fiber as it enters or exits equipment rack ducting
- Flexible/ribbed design allows for adjustment if drops cannot be positioned directly in line with equipment

STORAGE LOOPS			
DESCRIPTION	2" X 2"	4" X 4"	4" X 8"
[A] Fiber Storage Loop Inline	S2FSL-INL	S4FSL-INL	S8FSL-INL
Fiber Storage Loop Offset	—	S4FSL-OFF	S8FSL-OFF
SIDE DROP-OFF KITS			
[B] Side Drop-Off Kit (for Raceway Ducting)	S2DRP-DCT	S4DRP-DRP	—
Side Drop-Off Kit (for Round Tube)	S2DRP-TUB	—	—
Side Drop-Off Kit (for Square Tube)	S2DRP-STB	—	—
Outlet Trumpet	S2TRM-TRM	S4TRM-TRM	—

END CAPS				
DESCRIPTION	2" X 2"	4" X 4"	4" X 8"	4" X 12"
<b>[C]</b> End Cap, standard	—	S4END-CAP	S8END-CAP	—
End Cap, slotless	—	S4END-CSL	S8END-CSL	SWEND-CSL
End Cap, (two) .75" diameter knockouts	S2END-20D	—	—	—
End Cap, (one) 1.5" diameter knockout	S2END-38D	—	—	—
End Cap, (one) 1.5" hole	S2END-38H	—	—	—
End Cap Tube Outlet for 2" Tube	S2END-OUT	—	—	—
<b>[D]</b> End Cap, (two) 1.75" diameter knockouts	—	S4END-46D	—	—
<b>[E]</b> End Cap, (two) 1.25" diameter knockouts	—	S4END-32D	—	—

REDUCERS			
DESCRIPTION	4" X 4"	4" X 8"	4" X 12"
Reducer to 2" x 2"	S4RDR-RDR	—	—
<b>[F]</b> Reducer to 2" x 2" and Cover	S4RDR-RDC	—	—
Reducer to 4" x 4" Horizontal Cross and Cover	—	S8RDR-RDC	—
Reducer to 4" x 4" Right Hand	—	S8RDR-RRH	—
Reducer to 4" x 4" Right Hand and Cover	—	S8RDR-RHC	—
Reducer to 4" x 4" Left Hand	—	S8RDR-RLH	—
Reducer to 4" x 4" Left Hand and Cover	—	S8RDR-LHC	—
Reducer to 4" x 8"	—	—	SWRDR-RDR
Reducer to 4" x 8" and Cover	—	—	SWRDR-RDC

ADAPTERS (TO MATE W/ ADC DUCTING)*			
DESCRIPTION	4" X 4"	4" X 8"	4" X 12"
Adapter Kit to ADC 4" Duct	S4ADP-ADC	—	—
Adapter Kit to ADC 4" Tee	S4ADP-TEE	—	—
Left Hand Adapter Kit to ADC 6" Duct	—	S8ADP-LAD	—
Right Hand Adapter Kit to ADC 6" Duct	—	S8ADP-RAD	—

TUBING (PVC, NON UL 94V-0 MATERIAL)**	
DESCRIPTION	PART NO.
<b>[G]</b> Round, 2" diameter, 39" length (yellow)	S50RT-01M
Round, 2" diameter, 78" length (yellow)	S50RT-02M
Round, 1" diameter, 78" length (yellow)	S25RT-02M
Square, 2", 14" length (yellow)	S50ST-350
<b>[H]</b> Square w/ cover, 2", 14" length (yellow)	S5STC-350

2" x 4" and 2" x 8" components available by special order.

2" x 2" offered in yellow only.

Color: Yellow is standard. Orange and Black are special order and require additional lead time. Contact inside sales for more information.

\* = Adapters are special order and require additional lead time.

\*\* = PVC tubing also available in Black.



Yellow (S) Orange (O) Black (E)

Please contact inside sales at 800.722.2082 to order or for more information.

# CABLE MANAGEMENT | Fiber Raceway System



## MOUNTING HARDWARE

- Extensive selection enables Fiber Raceway installation above equipment racks and frames, under flooring, or on walls, ladder rack, or unistrut
- Other mounting hardware available - contact Tech Support at 800.824.3005 or +1.425.486.2222

MOUNTING HARDWARE	
DESCRIPTION	PART NO.
<b>[A]</b> 4" x 4" Wall-Mounting Kit	S4MNT-KIT
4" x 8" Wall-Mounting Kit	S8MNT-KIT
<b>[B]</b> 4" x 4" Wall Extension Bracket (up to 10") Mounting Kit	S4EXT-KIT
4" x 8" Wall Extension Bracket (up to 14") Mounting Kit	S8EXT-KIT
2" x 2" Duct-Mounting Bracket	S2DMB-000
<b>[C]</b> 4" x 4" Duct-Mounting Bracket	S4DMB-000
4" x 8" Duct-Mounting Bracket	S8DMB-000
4" x 12" Duct-Mounting Bracket	SWDMB-000
<b>[D]</b> 4" x 4" Suspension Kit (with 3.3' rod)	S4SUS-KIT
4" x 8" Suspension Kit (with 3.3' rod)	S8SUS-KIT
4" x 12" Suspension Kit (with 3.3' rod)	SWSUS-KIT
4" x 12" Suspension Kit (without rod)	SWSUS-WRD
2" x 2" Raised-Mounting Kit (for above or below cabinet, with 15" rod)	S1RMK-000
<b>[E]</b> 4" x 4" Raised-Mounting Kit (for above or below cabinet, with 15" rod)	S4RMK-000
4" x 8" Raised Mounting Kit (for above or below cabinet, with 15" rod)	S8RMK-000
4" x 12" Raised-Mounting Kit (for above or below cabinet, with 15" rod)	SWRMK-000
2" x 2" Ladder Rack/Unistrut Mounting Kit	S1LRU-000
<b>[F]</b> 4" x 4" Ladder Rack/Unistrut Mounting Kit	S4LRU-000
4" x 8" Ladder Rack/Unistrut Mounting Kit	S8LRU-000
<b>[G]</b> 5/8" Threaded Rod Side-Mount Bracket (threaded rod not included)	SMH00-SMB



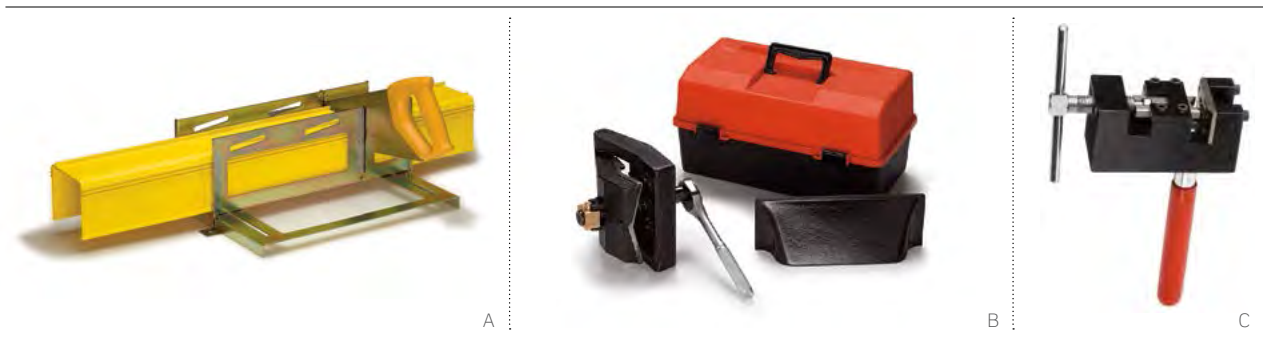

## TOOLS

- Several kit options for cutting and slotting duct during installation or upgrades
- Mitre boxes provide a stable channel for cutting ducting
- Cut-out tools prepare ducting for the addition of a Side Drop-Off Kit

TOOLS	
DESCRIPTION	PART NO.
Mitre Box (for 1.25" and 2" Ducting)*	SMTRE-050
<b>[A]</b> Mitre Box (for 4", 8", and 12" Ducting)*	SMTRE-300
<b>[B]</b> 2" Side Cut-Out Tool Kit (for use with 2" x 2" Side Drop-Off Kits)**	S2CUT-TOL
4" Side Cut-Out Tool Kit (for use with 2" x 4" and 4" x 4" Side Drop-Off Kits)**	S4CUT-TOL
<b>[C]</b> 2" End-Slot Tool (for use with 2" x 2" Joiners)	SSL0T-050
4" x 8" End-Slot Tool (for use with 4" x 4" and 4" x 8" Joiners)	SSL0T-200

\* = Ducting and saw not included.  
 \*\* = Ratchet and socket not included.

Please contact inside sales at 800.722.2082 to order or for more information.



## The Industry's Best Service & Support

### DANELLE MCCORMICK

Senior International Inside Sales Representative

Danelle has 17 years of experience working in customer service, and is knowledgeable in every region. She currently provides support to the Middle East and Latin America, but at any given time Danelle could be supporting any region when assistance is needed. During one day she could be providing quotes, managing orders, and working with staff at Leviton's warehouses and import/export office. "Providing support to customers is what I do best," she says. "I love to be busy and I embrace new challenges — it keeps the job exciting."

# CABLE MANAGEMENT | Versi-Duct® Vertical Management



## VERSI-DUCT CABLE MANAGEMENT SYSTEM

The unique Versi-Duct system is a versatile cable management solution for copper and fiber installations. The innovative system fits on any standard equipment rack, and accessories enable a wide range of cable management configurations.

## VERSI-DUCT 8" CHANNEL CABLE MANAGEMENT

- Ideal for today's large-scale deployments and CAT 6A installations with typical larger diameter cable
- 80" channel ships in two 40" pieces for easier handling and installation
- Channels available with standard or designer cover
- Channels include mounting bracket kit and two covers, one slack loop organizer, and one cable retainer, per 80" side (front or front/rear)
- Included cover features unique integrated dual-hinge for easy accessibility
- Channels can be side or center-mounted for better space utilization
- Large finger-passthrough space aligns with rack units
- Standard black replacement covers available through inside sales

### VERSI-DUCT 8" CHANNEL VERTICAL CABLE MANAGEMENT & ACCESSORIES

DESCRIPTION	FRONT ONLY	FRONT & REAR
Vertical 80" length, 8" W x 8" D channel, standard hinged black cover	8980L-VFO*	8980L-VFR
Vertical 80" length, 8" W x 8" D channel, designer hinged grey cover	<b>[A]</b> 8C80L-VFO*	<b>[B]</b> 8C80L-VFR
Vertical Center Mounting Bracket, 8" channel (bag of 4)	—	89265-BKT
Vertical Cable Retainer, 8" channel (bag of 6)	—	<b>[C]</b> 89265-WR1
Vertical Slack Loop Organizer, 8" channel (package of 2)	—	<b>[D]</b> 89265-SL1

\*Rear retrofit not available.

## 8" VERSI-DUCT CAPACITY CHART

Use the chart below to determine maximum recommended cable capacity for 8" Versi-Duct managers, based on average cable outside diameter. To ensure proper bend radius and space for future additions, do not fill to capacity at initial installation.

FEATURE	CHANNEL DEPTH (WxD)	USABLE AREA (IN²)	CAT 6A CAPACITY (.330" CABLE)	CAT 6 CAPACITY (.230" CABLE)	CAT 5E CAPACITY (.185" CABLE)
8" Channel Size	7.88" x 6.9"	54.3	159	327	505
Finger Spacing	5.5" x 1"	5.5	24	50	77
Large Passthrough	4.8" x 2.6"	11.2	49	101	156
Small Passthrough	2.6" dia.	5.3	23	48	74

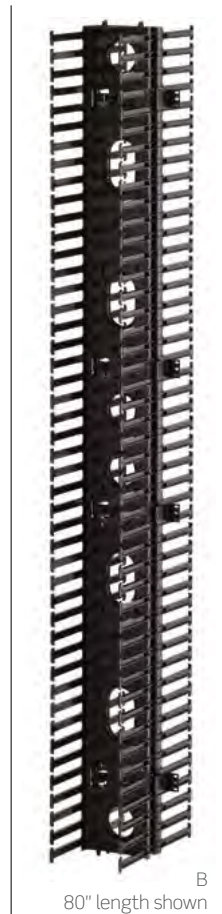

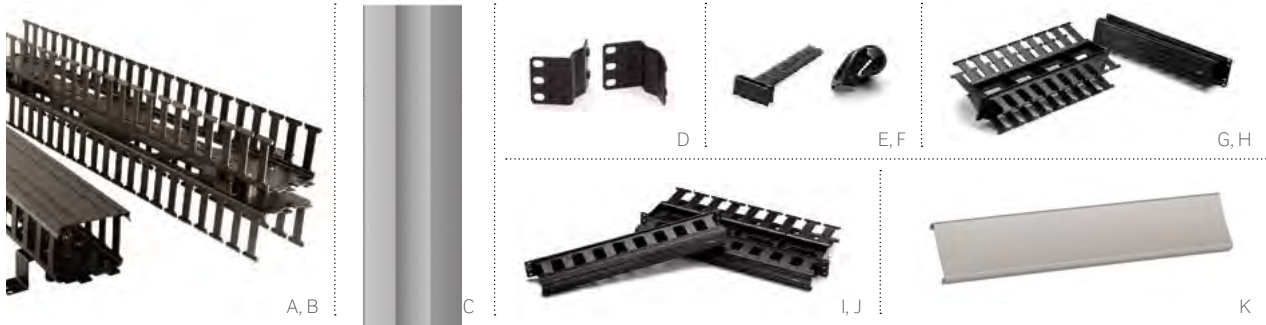

## VERSI-DUCT 5" CHANNEL CABLE MANAGEMENT

- 80" channel ships in two 40" pieces for easier handling and installation
- Interlocking tabs maintain flush channel alignment
- Finger spacing aligns with rack units

## VERSI-DUCT HORIZONTAL CABLE MANAGEMENT

- Fits all standard 19" racks
- Includes bend radius compliant clips
- Finger spacing aligns with patch panel port openings to better manage patch cords
- Standard black replacement covers available through inside sales



Mount the Slack Loop Organizer on the duct fingers to manage excess cables.

VERSI-DUCT 5" CHANNEL VERTICAL CABLE MANAGEMENT & ACCESSORIES			
DESCRIPTION	FRONT ONLY		FRONT & REAR
Vertical 80" length, 5" W x 4" D channel, standard snap-on black cover (included)	4980L-VFO†	[L]	4980L-VFR
Vertical 40" length, 5" W x 4" D channel, standard snap-on black cover (included)	[A] 4940L-VFO†	[B]	4940L-VFR
Vertical 40" Designer Cover, 5" channel, snap-on, grey (set of 2)	—	[C]	59265-5DC
Mounting Bracket, 5" channel (set of 2)	—	[D]	49265-BKT
Versi-Duct Slack Loop Organizer (set of 2)	—		49265-SL1
Versi-Duct Slack Loop Organizer (Extended) (set of 2)	—		49265-SL2

VERSI-DUCT HORIZONTAL CABLE MANAGEMENT & ACCESSORIES			
Horizontal Manager, 2RU, 3" W x 3" D front, 2" W x 4" D rear*, with cover	[G] 492RU-HFO	[H]	492RU-HFR
Horizontal Manager, 1RU, 1.5" W x 3" D front, 1.5" W x 4" D rear*, with cover	[I] 491RU-HFO	[J]	491RU-HFR
Horizontal Designer Cover, 2RU, snap-on, grey	—	[K]	49265-DC2
Horizontal Designer Cover, 1RU, snap-on, grey	—		49265-DC1
Horizontal Cable Retainer (10 per package)	—	[E]	49265-WR1
Horizontal Cover Hinge (4 per package)	—	[F]	49265-HNG

†Rear retrofit not available.

\*Bend radius clips included.

## 5" VERSI-DUCT CAPACITY CHART

Use the chart below to determine maximum recommended cable capacity for 5" Versi-Duct managers, based on average cable outside diameter. To ensure proper bend radius and space for future additions, do not fill to capacity at initial installation.

FEATURE	CHANNEL DEPTH (WXD)	USABLE AREA (IN <sup>2</sup> )	CAT 6A CAPACITY (.330" CABLE)	CAT 6 CAPACITY (.230" CABLE)	CAT 5E CAPACITY (.185" CABLE)
5" Channel Size	4.75" x 3.9"	18.5	54	111	172
Finger Spacing	3" x 1"	3.0	13	27	42
Passthrough	3.5" x 1"	3.5	15	32	49

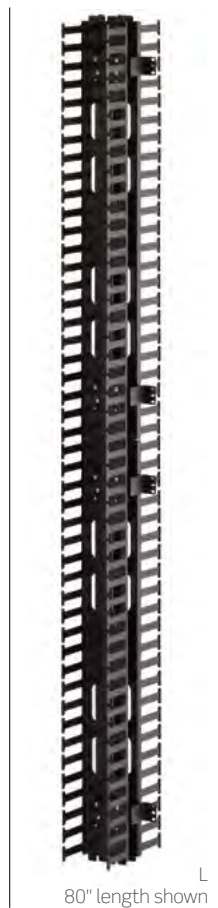

80" length shown

CABLE MANAGEMENT

# CABLE MANAGEMENT | Horizontal Cable Managers



## HORIZONTAL CABLE MANAGERS

- Available in 1RU, 2RU, and 4RU sizes
- All mount to standard 19" racks and cabinets
- 4RU manager includes a shelf to support patch cords
- Horizontal managers support transition to vertical management
- Combo Manager offers front and rear management
- Attach included cable manager to C1 Ultra Blank Panel for high-density installations

HORIZONTAL CABLE MANAGERS						
DESCRIPTION	FLAT	FLAT W/ METAL COVER	ANGLED	RECESSED- ANGLED	RECESSED- FLAT	
Horizontal Manager, 1RU, 4" metal rings	<b>[A]</b> 49253-LPM	4925C-LPM	<b>[B]</b> 49254-LPM	4W254-LPM	—	
Horizontal Manager, 2RU, 4" metal rings	49253-BCM	<b>[C]</b> 4925C-BCM	49254-BCM	4W254-BCM	—	
Horizontal Manager, 2RU, 2" metal rings	49253-2CM	—	—	—	—	
Horizontal Manager, 4RU, 4" metal rings	<b>[D]</b> 49253-4CM	4925C-4CM	—	—	—	
Horizontal Manager, 1RU, 6" metal rings	49253-6PM	—	—	—	—	
Horizontal Manager, 2RU, 6" metal rings	49253-6MR	—	—	—	—	
Horizontal Manager, 4RU, 6" metal rings	49253-6CM	4925C-6CM	—	—	—	
Recessed Horizontal Manager, 1RU, 3" metal rings	—	—	—	—	<b>[E]</b> 49253-RCM	
Horizontal Manager, 2RU, w/ plastic saddles	<b>[F]</b> 49252-PO2	—	—	—	—	
Horizontal Manager, 1RU, w/ plastic saddles	<b>[G]</b> 49252-PO1	—	—	—	—	
Combo Front and Rear Manager, 2RU	<b>[H]</b> 49252-PCM	—	—	—	—	
VELCRO® Brand Horizontal Manager, 1RU	<b>[I]</b> 41150-019	—	—	—	—	
Tie Wrap Bar, 1" H x 1.5" D	<b>[J]</b> 49258-TWB	—	—	—	—	
C1 Ultra Blank Panel / Cable Manager, 2RU	<b>[K]</b> C1253-2CM	—	—	—	—	
Horizontal Manager, 2RU with 4" Slack Loop Organizers (4)	<b>[L]</b> 49300-SM2	—	—	—	—	
Horizontal Manager, 4RU with 4" Slack Loop Organizers (6)	49300-SM4	—	—	—	—	

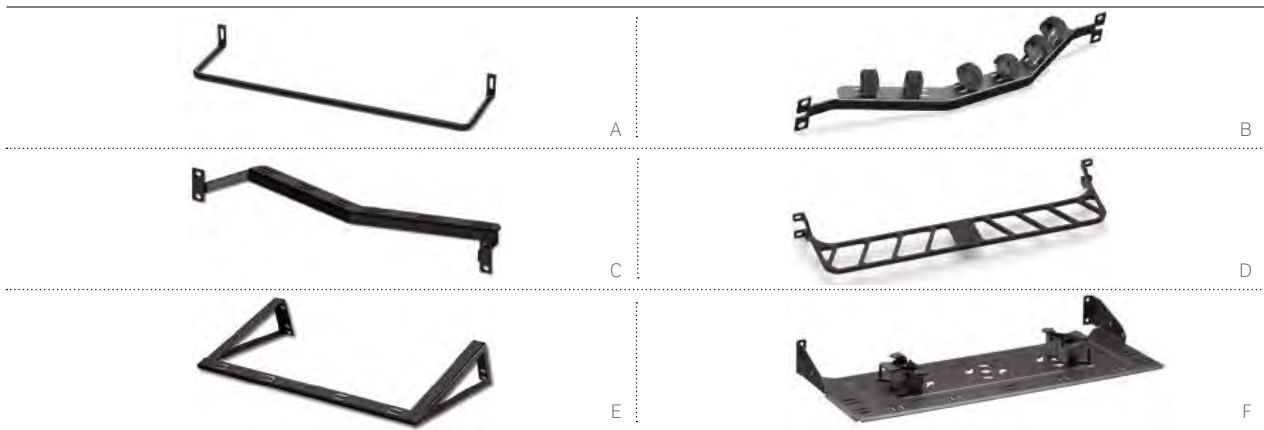

## REAR CABLE MANAGEMENT BARS

- Standard Flat Cable Management Bar attaches directly to patch panels
- Standard Angled and Recessed-Angled Cable Management Bars attach directly to rack
- Extended Cable Management Bar handles large cable volumes and includes six VELCRO® Brand straps
- High-Density Cable Management Bar is constructed of die-cast aluminum to support heavy loads of cable and mounts on front or rear of rack
- Rear Cable Management Bar for Active Equipment offers extended depth for power cord support and cutouts for air circulation
- e2XHD Rear Cable Manager supports any Leviton panel (see page B29 for more details)
- e2XHD Rear Cable Manager includes rings to help manage and route incoming fiber cables

## REAR CABLE MANAGEMENT BARS

DESCRIPTION	FLAT	ANGLED	RECESSED-ANGLED
Standard Cable Management Bar	[A] 49005-CMB	[B] 49006-AMB	[C] 4W006-AMB
High-Density Cable Management Bar, 1RU	[D] 49005-DMB	—	—
Rear Cable Manager for Active Equipment, 2RU	[E] 41188-SM2	—	—
e2XHD Rear Cable Manager for Flat Panel, with cable management rings (four ¼" rings)	[F] E2X1F-CMB	—	—

## SPOTLIGHT

### Cable Management Options



#### High-Density Cable Management Bar

Constructed of durable, lightweight die-cast aluminum, the High-Density 1RU Cable Management Bar is excellent for heavy cable loads. The bar supports up to 48 CAT 6A, CAT 6, or CAT 5e horizontal cables and fits all industry-standard 19" racks and cabinets. It can be mounted on the front or rear of the rack.

#### Vertical Cable Management Rings

Support and manage vertical and horizontal cable loads with Vertical Cable Management Rings (shown on page C18). The open ring solution is ideal for tight spaces and smaller deployments. Install with the Mounting Tie Bracket (shown on page C18) for center mounting.



# CABLE MANAGEMENT | Blanks & Transitional Covers



A-C



D, E



F, G



H, I

## BLANK PANEL INSERTS

- Provide a seamless look and designate rack space for future expansion
- Available for flat, angled, and recessed-angled patch panels
- Attach included cable manager to C1 Ultra Blank Panel when additional cord management is needed

## TRANSITIONAL COVERS

- Provide clean, aesthetic transition from angled patch panels to flat equipment
- Improve thermal management
- Available for angled and recessed-angled patch panels

BLANK PANEL INSERTS				
DESCRIPTION	STANDARD	ANGLED	RECESSED-ANGLED	
Blank Panel, 4RU	<b>[A]</b> 49254-BP4	—	—	
Blank Panel, 2RU	<b>[B]</b> 49254-BP2	<b>[E]</b> 49254-BA2	<b>[F]</b> 4W254-BA2	
Blank Panel, 1RU	<b>[C]</b> 49254-BP1	<b>[D]</b> 49254-BA1	4W254-BA1	
C1 Ultra Blank Panel / Cable Manager, 2RU	<b>[G]</b> C1253-2CM	—	—	
TRANSITIONAL COVERS				
Transitional Cover, 1RU	—	<b>[H]</b> 49254-BC1	<b>[I]</b> 4W254-BC1	

covers

CABLE MANAGEMENT

## SPOTLIGHT | Angled & Recessed-Angled Panels

Address specific rack and cabinet requirements with Leviton angled and recessed-angled patch panels. Standard-angled panels improve patch cord routing in high-density applications, while recessed-angled panels are ideal for applications with minimal depth in front of the panel. Specialized cable management is available for both styles, including standard bars, horizontal managers, blanks, and transitional covers.

Find angled and recessed-angled patch panels on pages A16-A17.



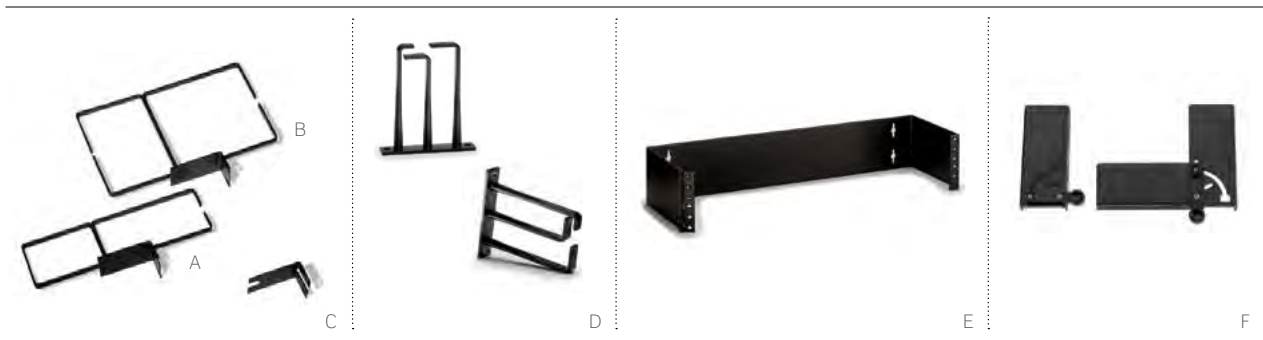

## CABLE MANAGEMENT RINGS

- Vertical Management Rings are an open ring solution that can be installed in tight spaces and smaller deployments
- Mounting Tie Bracket allows rings to be positioned between racks
- Vertical Transition Rings are used for vertical and horizontal cable management and are compatible with flat and angled panels

## HINGED WALL-MOUNT BRACKETS

- Designed for installations where space is constrained and racks are not used
- 6"-deep brackets allow for proper cable management
- 2RU, 3RU, and 4RU sizes

## FRONT HINGED BRACKET

- Simplifies process of terminating cables to rear of patch panels when access is limited
- Easy-access quick-release latches drop to 90° and 120° positions
- Rack or wall mountable

CABLE MANAGEMENT RINGS	
DESCRIPTION	PART NO.
[A] 3" Vertical Management Rings	49260-MR3
[B] 6" Vertical Management Rings	49260-MR6
[C] Mounting Tie Bracket	49261-BKT
[D] Vertical Transition Rings for Angled and Recessed-Angled Panels, 2RU	49262-HR1
HINGED WALL-MOUNT BRACKETS	
[E] Hinged Wall-Mount Bracket, 2RU, 6" depth	49251-W62
Hinged Wall-Mount Bracket, 3RU, 6" depth	49251-W63
Hinged Wall-Mount Bracket, 4RU, 6" depth	49251-W64
FRONT HINGED BRACKET	
[F] Front Hinged Bracket, 3RU	49400-FHB

Front Hinged Bracket in the 120° position





A-C



D, E



F



G



H

## VELCRO BRAND TIE WRAPS

- Available in 5", 8", and 12" lengths (0.5" width)
- Slot helps secure fastening without overtightening
- All wraps come with 25 units per roll

## VELCRO BRAND WRAPS - BULK ROLLS

- Available in 15', 75', and 600' bulk rolls (0.5" width)
- Cut to desired length

Maroon products UL Listed for use in plenum or air handling spaces per National Electric Code (NEC) Section 300.

## VELCRO BRAND COMPRESSION STRAPS

- Available in 15" lengths (all 0.5" width)
- Adjustable to support a variety of loads
- Easy feedthrough slot helps secure fastening without overtightening
- Strap-enclosed area equals 6" diameter
- Holds up to 320 CAT 5e, 200 CAT 6, or 100 CAT 6A cables in vertical bundles
- 10 units per pack

## VELCRO BRAND WRAPS - SOFTCINCH LITE ROLLS

- Thinner depth for smaller bundles
- Tear by hand for quick application
- Available in 75' roll (0.5" width)

### VELCRO BRAND CABLE FASTENERS

DESCRIPTION	BLACK	BLUE	YELLOW	ORANGE	MAROON (PLENUM RATED)
<b>[A]</b> Tie Wrap, 5" (25 units per roll)	43105-005	43105-05L	43105-05Y	43105-05O	43105-05P
<b>[B]</b> Tie Wrap, 8" (25 units per roll)	43108-008	43108-08L	43108-08Y	43108-08O	43108-08P
<b>[C]</b> Tie Wrap, 12" (25 units per roll)	43112-012	43112-12L	43112-12Y	43112-12O	43112-12P
<b>[D]</b> Bulk Roll, 15'	43115-015	43115-15L	43115-15Y	43115-15O	43115-15P
<b>[E]</b> Bulk Roll, 75'	43115-075	43115-75L	43115-75Y	43115-75O	43115-75P
<b>[F]</b> Bulk Roll, 600'	43115-600	—	—	—	—
<b>[G]</b> Compression Strap (10 units per pack)	44115-15E	44115-15L	44115-15Y	—	—
<b>[H]</b> SoftCinch Lite Roll, 75'	45115-75E	—	—	—	—



Black



Blue



Yellow



Orange



Maroon



# CABLE MANAGEMENT | VELCRO® Brand Utility Fasteners

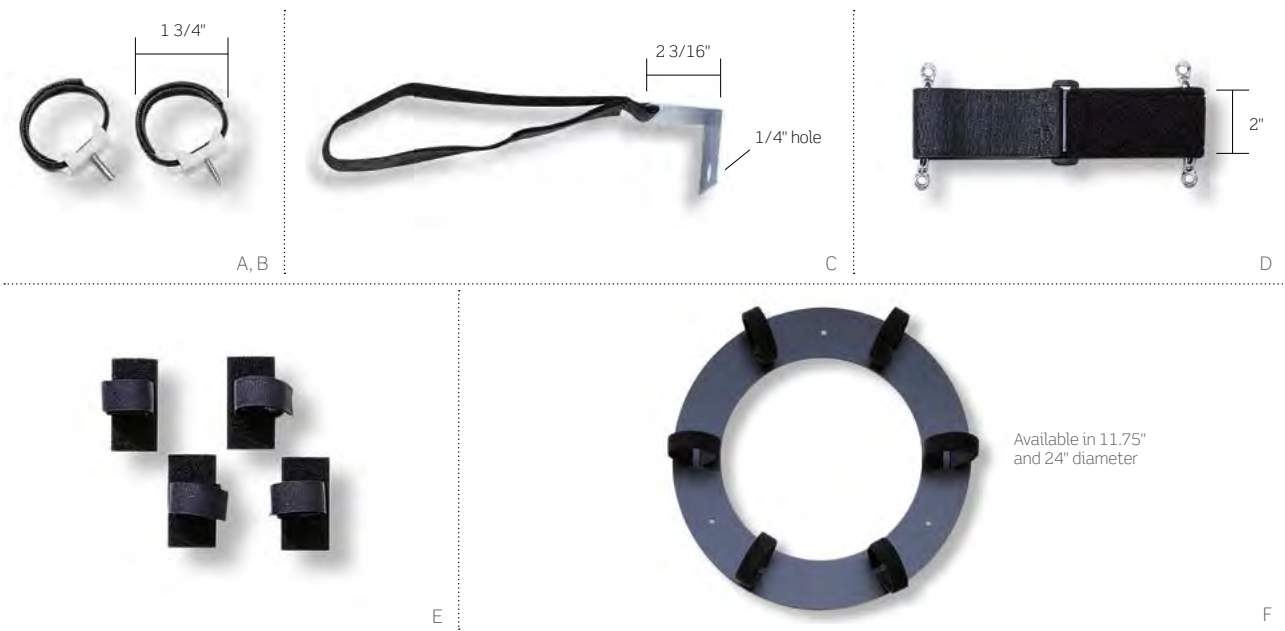

## VELCRO BRAND UTILITY FASTENERS

- Saddle ties attach to wood surfaces, relay racks, and enclosures
- Saddle ties are 8 3/8" in length
- Compression straps are an ideal solution for heavy vertical cable runs, 5" in diameter
- J-Hooks are height adjustable to bypass obstacles, and open to 6" diameter
- Workstation loops, with 1.25" diameter, attach with convenient peel-off adhesive
- Storage rings for inside and outside plant ensure copper and fiber optic bend radius; loops included

VELCRO BRAND UTILITY FASTENERS	
DESCRIPTION	PART NO.
<b>[A]</b> Saddle Ties w/ 10/32 metal rack screws (10 per pack)	41020-SPR
<b>[B]</b> Saddle Ties w/ #8 wood screws (10 per pack)	41010-SPW
<b>[C]</b> J-Hook (10 per pack)	46700-SLG
<b>[D]</b> Compression Strap (2 per pack)	45224-RCS
<b>[E]</b> Workstation Loops w/ peel-off adhesive (25 per pack)	41225-SAP
Storage Rings, Inside Plant, 11.75" diameter	48900-IFR
<b>[F]</b> Storage Rings, Outside Plant, 24" diameter	48900-0FR

## SPOTLIGHT

Protect Cables with Genuine VELCRO Brand Fasteners

Use **VELCRO Brand fasteners** to secure all cable bundles. Our genuine VELCRO Brand products won't crush or damage cables like tie wraps can, and are reusable for moves, adds, and changes (MACs). Plus, with our extensive range of fastener styles, colors, and sizes, Leviton has the perfect VELCRO Brand cable management solution for your unique needs.

# CABLE MANAGEMENT | Zone Enclosures



zone enclosures

CABLE MANAGEMENT

## ZONE ENCLOSURES

- Provide flexible consolidation points in ceiling or floor
- Simplify moves, adds, and changes (MACs)
- Plenum rated and include fire-rated foam sealing kits
- Significant reduction in cable pathway loading
- Use as a telecom enclosure (TE) for cabling flexibility

## 2' X 2' PASSIVE RAISED-FLOOR ENCLOSURES

- Fit in air handling space under 8" raised floors
- House two 4RU (8RU total) racks for standard 19" components
- Rotating patch panel mounting provides easy access to rear of panels

## CEILING ENCLOSURES

- Install flush with drop ceiling
- Fully hinged drop-down doors support installed equipment and open to face technician
- Active and passive styles available
- Mount into standard 2' x 2' and 2' x 4' ceiling tiles
- Active enclosures include AC power back box and venting for active equipment

ZONE ENCLOSURES	
DESCRIPTION	PART NO.
[A] Active Ceiling Enclosure, 2' x 2', 2RU active and 5RU passive space	Z1000-AC2
[B] Active Ceiling Enclosure, 2' x 4', 4RU active and 10RU passive space	Z1000-AC4
[C] Passive Raised-Floor Enclosure, 8" depth, 8RU passive space	Z1000-PF2
[D] Passive Ceiling Enclosure, 2' x 2', 5RU passive space	Z1000-PC2

## SPOTLIGHT

## Zone Cabling Design Benefits

In a **zone cabling design**, cables are routed from the telecommunications room (TR) to appropriately placed telecommunications enclosures (TE). Cabling is then run from the zone enclosure to each work area (WA). In an Active Zone Enclosure System, a single fiber run can support dozens of work areas, significantly reducing cable pathway loading and TR space requirements. Zone cabling designs are ideal for open office architecture. Zone cabling benefits include:

- Maximum infrastructure flexibility
- Improved network performance
- Simplified moves, adds, and changes
- Reduced floor space usage
- Significantly reduced cost of ownership

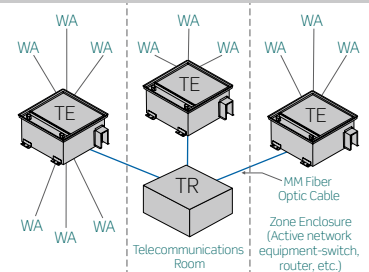



## 5" WIRELESS ACCESS POINT CEILING ENCLOSURE

- Single edge-protected access port includes a fire-rated foam sealing kit
- Suitable for installation in air spaces
- Mount into a standard 2' x 2' ceiling tile

## 4" WIRELESS ACCESS POINT CEILING ENCLOSURE

- Accommodates one wireless access point or bridge
- Removable door-mounted bracket supports equipment up to 10.5" W x 5.5" H x 1.875" D
- Includes fully hinged, lockable door with two round holes for access point antennae

## CEILING ENCLOSURE FACEPLATE

- Fits 5"-depth enclosure
- Fully hinged and lockable

## WALL-MOUNT ENCLOSURE

- Rugged steel construction with lock assembly
- Accommodates equipment sized 9.5" W x 6.5" H x 2.75" D

### WIRELESS ACCESS POINT CEILING ENCLOSURES

DESCRIPTION	PART NO.
<b>[A]</b> Wireless Access Point Ceiling Enclosure, 5" depth, faceplate sold separately	W1000-WC5
<b>[B]</b> Wireless Access Point Ceiling Enclosure, 4" depth, with faceplate	W1000-WC0

### WIRELESS ACCESS POINT CEILING ENCLOSURE FACEPLATES (REQUIRED FOR 5" ENCLOSURE)

<b>[C]</b> Blank Faceplate (fits 5" Wireless Access Point Enclosure)	W1000-F01
--	-----------

### WIRELESS ACCESS POINT WALL-MOUNT ENCLOSURE

<b>[D]</b> Wireless Access Point Wall-Mount Enclosure (accommodates Cisco Aironet® 350 or equivalent)	W1000-WW0
---	-----------

All enclosures and faceplates are powder-coated white.



# POWER SOLUTIONS



SECTION

D

---

## SECTION D CONTENTS

POWER DISTRIBUTION UNITS (PDUs)	<b>D3</b>	FLX Series
	<b>D9</b>	Switched & Metered Series
	<b>D11</b>	P1000 Series
	<b>D13</b>	5500 & 5505 Series
	<b>D14</b>	4500 Series

# POWER DISTRIBUTION | FLX Series

Leviton FLX Series PDUs provide reliable power distribution into racks and cabinets, with output power ranging from 2.0 kW to 12.5 kW. Metered units include a Smart Meter Technology display showing voltage, amperage, and wattage for the total PDU and for each individual branch (3-phase units). FLX Series PDUs are available in a wide selection of input plugs and output receptacles meeting both NEMA and IEC standards. All PDUs include UL-rated breakers for branch circuit protection. The 70" PDUs mount vertically in racks or cabinets, and feature data-center quality design and construction.

## RECOMMENDED APPLICATIONS:

Data Center Cabinets

Telecommunications Racks

Quick Network Deployment



## INPUT FLEXIBILITY

- 120V & 208V Single-Phase and 208V 3-Phase (WYE or Delta)
- 12 input plug options meeting both NEMA and IEC 60309 standards
- 208V units (single and 3-phase) provided with Type DP cable for NEC 645 compliance
- 120V units available with locking or non-locking input plugs
- Cord lengths from 3 to 15 feet (10 feet standard)



## DATA CENTER READY

- Tested for temperature, humidity, vibration, and shock conditions that exceed the ranges in section 5 of the Telcordia GR63 standard
- 18-gauge cold-rolled steel construction
- All 208V units include UL-489 circuit breakers
- 208V units (single and 3-phase) provided with Type DP cords for NEC 645 compliance
- Grounding stud provides easy and reliable grounding
- cULus Listed 60950-1
- Every unit is factory burned-in and tested

power distribution

POWER





### SMART METER TECHNOLOGY

- Displays amps, volts, and watts
- Gravity sensor detects PDU orientation and auto-inverts display
- Auto-scrolling feature on 3-phase units displays bank-level information
- Amperage and wattage accuracy:  $\pm 5\%$
- Voltage accuracy:  $\pm 2\%$
- Blue LEDs increase visibility and require minimal power to operate display

power distribution

POWER



### OUTPUT FLEXIBILITY

- Output power ranging from 2.0 kW to 12.5 kW
- 3-phase units available with 120V, 208V, and 120V/208V output
- Output receptacles include NEMA 5-20R and L6-20R; IEC 60320 C13 and C19















### MOUNTING FLEXIBILITY

- Bracket and button-mounting hardware included for compatibility with a wide range of rack and cabinet applications
- Optional adjustable rack-mounting bracket available for open-frame racks\*
- Cable management available for securing cords and improving aesthetics\*





\*See page D5 for FLX Series accessories.

# POWER DISTRIBUTION | FLX Series

## INPUT PLUG TYPES

Single Phase 120V	NEMA  5-20P	NEMA  L5-20P	NEMA  L5-30P
Single Phase 208V	NEMA  L6-20P	NEMA  L6-30P	
3-Phase 208V Delta	NEMA  L15-20P	NEMA  L15-30P	Non-NEMA  CS8365C
			IEC 60309  460P9W
3-Phase 208V WYE	NEMA  L21-20P	NEMA  L21-30P	IEC 60309  560P9W

## OUTPUT RECEPTACLE TYPES

NEMA  5-20R 120V	NEMA  L6-20R 208V	IEC 60320  C13 208V	IEC 60320  C19 208V
---	--	--	--

## FLX SERIES ACCESSORIES

DESCRIPTION	PART NO.
Adjustable Extension Mounting Bracket	PDURK-BKT
Power Cord Management Bar	PDURK-MGR

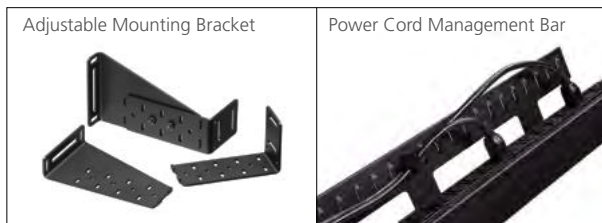

Single-Phase  
208V FLX PDU

3-Phase  
208V FLX PDU

Dimensions: 70" H x 2.3" W x 2.4" D



## POWER DISTRIBUTION | FLX Series > Options

The FLX Series offers a variety of configurations to meet many different applications and power requirements. The information contained in the following tables will assist you in finding the right FLX model to meet your needs.

### FLX PDU INPUT AND OUTPUT CHARACTERISTICS BY PLUG TYPE

PDU INPUT				PDU OUTPUT	
PLUG TYPE	INPUT VOLTAGE	PLUG RATING	CONTINUOUS INPUT CURRENT	OUTPUT POWER	MAX. OUTPUT CURRENT
5-20P	120V Single Phase	20A	16A	2.0 kW	16A Total
L5-20P	120V Single Phase	20A	16A	2.0 kW	16A Total
L5-30P	120V Single Phase	30A	24A	3.0 kW	24A Total
L6-20P	208V Single Phase	20A	16A	3.3 kW	16A Total
L6-30P	208V Single Phase	30A	24A	5.0 kW	24A Total
L15-20P	208V 3-Phase Delta	20A	16A	5.8 kW	9.3A / Bank
L15-30P	208V 3-Phase Delta	30A	24A	8.6 kW	13.8A / Bank
CS8365C	208V 3-Phase Delta	50A	35A	12.5 kW	20A / Bank
460P9W	208V 3-Phase Delta	60A	35A	12.5 kW	20A / Bank
L21-20P	208V 3-Phase WYE	20A	16A	5.8 kW	9.3A / Bank
L21-30P	208V 3-Phase WYE	30A	24A	8.6 kW	13.8A / Bank
560P9W	208V 3-Phase WYE	60A	35A	12.5 kW	20A / Bank

### FLX PDU PRODUCT LIST BY OUTPUT RECEPTACLE CONFIGURATION

OUTLET QTY & TYPE	120V SINGLE PHASE			208V SINGLE PHASE		3-PHASE WYE			3-PHASE DELTA			
	5-20P	L5-20P	L5-30P	L6-20P	L6-30P	L21-20P	L21-30P	560P9W	L15-20P	L15-30P	CS8365C	460P9W
<b>(24) 5-20R</b>	FM106	FM107	FM105	—	—	—	—	—	—	—	—	—
<b>(24) C13; (6) C19; (6) 5-20R</b>	—	—	—	—	—	FM379	FM380	FM381	—	—	—	—
<b>(36) C13; (6) C19</b>	—	—	—	—	—	FM355	FM356	FM388	FM413	FM403	FM354	FM429
						FB355	FB356	FB388	FB413	FB403	FB354	FB429
<b>(24) C13; (6) C19</b>	—	—	—	FM204	FM206	FM313	FM315	FM361	FM410	FM445	FM337	FM424
				FB204	FB206	FB313	FB315	FB361	FB410	FB445	FB337	FB424
<b>(24) C13; (4) C19; (4) L6-20R</b>	—	—	—	—	—	FM373	FM374	FM375	FM431	FM432	FM433	FM434
						FB373	FB374	FB375	FB431	FB432	FB433	FB434
<b>(8) C13; (4) L6-20R; (12) 5-20R</b>	—	—	—	—	—	FM376	FM377	FM378	—	—	—	—
						—	—	—				
<b>(12) C13; (12) C19</b>	—	—	—	—	—	FM389	FM390	FM391	FM450	FM451	FM452	FM453
						FB389	FB390	FB391	FB450	FB451	FB452	FB453
<b>(12) L6-20R</b>	—	—	—	—	—	FM347	FM348	FM371	FM406	FM407	FM346	FM426
						FB347	FB348	FB371	FB406	FB407	FB346	FB426
<b>(36) 5-20R</b>	—	—	—	—	—	FM310	FM311	FM360	—	—	—	—
						FB310	FB311	FB360				
<b>(12) C13; (18) C19</b>	—	—	—	—	—	FM382	FM386	FM387	FM446	FM447	FM448	FM449
						FB382	FB386	FB387	FB446	FB447	FB448	FB449
<b>(24) C13; (3) 5-20R</b>	—	—	—	—	—	FM330	FM331	FM367	—	—	—	—
						FB330	FB331	FB367				
<b>(36) C13</b>	—	—	—	—	—	FM353	FM324	FM364	FM411	FM412	FM352	FM428
						FB353	FB324	FB364	FB411	FB412	FB352	FB428
<b>(12) L6-20R</b>	—	—	—	FM207	FM210	—	—	—	—	—	—	—
				FB207	FB210							

FLX PDUs are available with a cord length of 3 - 15 feet. The default cord length is 10 feet.  
 — Indicates configuration is not available.

# POWER DISTRIBUTION | FLX Series > Part Numbers

FLX PDUs ship in five days or less for quantities up to 25 units. For delivery information that includes transit time from the factory to your specific location, please contact Leviton inside sales at 800.722.2082.

SINGLE-PHASE 120V INPUT POWER DISTRIBUTION UNITS (PDUs)								
PART NO.		INPUT			OUTPUT			
METERED	BASIC*	PLUG TYPE	VOLTAGE	CONTINUOUS CURRENT	POWER	VOLTAGE	RECEPTACLE QTY & TYPE	MAXIMUM CURRENT
FM106-10S	—	5-20P	120V Single Phase	16A	2.0 kW	120V	(24) 5-20R	16A Total
FM107-10L	—	L5-20P	120V Single Phase	16A	2.0 kW	120V	(24) 5-20R	16A Total
FM105-10L	—	L5-30P	120V Single Phase	24A	3.0 kW	120V	(24) 5-20R	24A Total

SINGLE-PHASE 208V INPUT POWER DISTRIBUTION UNITS (PDUs)								
PART NO.		INPUT			OUTPUT			
METERED	BASIC	PLUG TYPE	VOLTAGE	CONTINUOUS CURRENT	POWER	VOLTAGE	RECEPTACLE QTY & TYPE	MAXIMUM CURRENT
FM204-10L	FB204-10L	L6-20P	208V Single Phase	16A	3.3 kW	208V	(24) C13; (6) C19	16A Total
FM207-10L	FB207-10L	L6-20P	208V Single Phase	16A	3.3 kW	208V	(12) L6-20R	16A Total
FM206-10L	FB206-10L	L6-30P	208V Single Phase	24A	5.0 kW	208V	(24) C13; (6) C19	24A Total
FM210-10L	FB210-10L	L6-30P	208V Single Phase	24A	5.0 kW	208V	(12) L6-20R	24A Total

3-PHASE 208V INPUT POWER DISTRIBUTION UNITS (PDUs)								
PART NO.		INPUT			OUTPUT			
METERED	BASIC	PLUG TYPE	VOLTAGE	CONTINUOUS CURRENT	POWER	VOLTAGE	RECEPTACLE QTY & TYPE	MAXIMUM CURRENT
FM431-10L	FB431-10L	L15-20P	208V 3-Phase Delta	16A	5.8 kW	208V	(24) C13; (4) C19; (4) L6-20R	9.3A / Bank
FM410-10L	FB410-10L	L15-20P	208V 3-Phase Delta	16A	5.8 kW	208V	(24) C13; (6) C19	9.3A / Bank
FM413-10L	FB413-10L	L15-20P	208V 3-Phase Delta	16A	5.8 kW	208V	(36) C13; (6) C19	9.3A / Bank
FM450-10L	FB450-10L	L15-20P	208V 3-Phase Delta	16A	5.8 kW	208V	(12) C13; (12) C19	9.3A / Bank
FM446-10L	FB446-10L	L15-20P	208V 3-Phase Delta	16A	5.8 kW	208V	(12) C13; (18) C19	9.3A / Bank
FM406-10L	FB406-10L	L15-20P	208V 3-Phase Delta	16A	5.8 kW	208V	(12) L6-20R	9.3A / Bank
FM411-10L	FB411-10L	L15-20P	208V 3-Phase Delta	16A	5.8 kW	208V	(36) C13	9.3A / Bank
FM373-10L	FB373-10L	L21-20P	208V 3-Phase WYE	16A	5.8 kW	208V	(24) C13; (4) C19; (4) L6-20R	9.3A / Bank
FM313-10L	FB313-10L	L21-20P	208V 3-Phase WYE	16A	5.8 kW	208V	(24) C13; (6) C19	9.3A / Bank
FM379-10L	—	L21-20P	208V 3-Phase WYE	16A	5.8 kW	120V & 208V	(24) C13; (6) C19; (6) 5-20R	9.3A / Bank
FM355-10L	FB355-10L	L21-20P	208V 3-Phase WYE	16A	5.8 kW	208V	(36) C13; (6) C19	9.3A / Bank
FM389-10L	FB389-10L	L21-20P	208V 3-Phase WYE	16A	5.8 kW	208V	(12) C13; (12) C19	9.3A / Bank
FM382-10L	FB382-10L	L21-20P	208V 3-Phase WYE	16A	5.8 kW	208V	(12) C13; (18) C19	9.3A / Bank
FM347-10L	FB347-10L	L21-20P	208V 3-Phase WYE	16A	5.8 kW	208V	(12) L6-20R	9.3A / Bank
FM330-10L	FB330-10L	L21-20P	208V 3-Phase WYE	16A	5.8 kW	120V & 208V	(24) C13; (3) 5-20R	9.3A / Bank
FM310-10L	FB310-10L	L21-20P	208V 3-Phase WYE	16A	5.8 kW	120V	(36) 5-20R	9.3A / Bank
FM353-10L	FB353-10L	L21-20P	208V 3-Phase WYE	16A	5.8 kW	208V	(36) C13	9.3A / Bank
FM376-10L	—	L21-20P	208V 3-Phase WYE	16A	5.8 kW	120V & 208V	(8) C13; (4) L6-20R; (12) 5-20R	9.3A / Bank

FLX PDUs are available with a cord length of 3 - 15 feet in 1-foot increments.

The default cord length is 10 feet. To order a different cord length, simply replace the 10 with the desired length. For example, FM380-15L features a 15' cord.

Standard dimensions are 70" H x 2.3" W x 2.4" D. For units with UL 489-rated circuit breakers, add an additional 1" of depth at the base of the PDU for the circuit breaker enclosure.

\* Basic = non-metered

# POWER DISTRIBUTION | FLX Series > Part Numbers

## 3-PHASE 208V INPUT POWER DISTRIBUTION UNITS (PDUs)

PART NO.		INPUT			OUTPUT			
METERED	BASIC*	PLUG TYPE	VOLTAGE	CONTINUOUS CURRENT	POWER	VOLTAGE	RECEPTACLE QTY & TYPE	MAXIMUM CURRENT
FM451-10L	FB451-10L	L15-30P	208V 3-Phase Delta	24A	8.6 kW	208V	(12) C13; (12) C19	13.8A / Bank
FM447-10L	FB447-10L	L15-30P	208V 3-Phase Delta	24A	8.6 kW	208V	(12) C13; (18) C19	13.8A / Bank
FM407-10L	FB407-10L	L15-30P	208V 3-Phase Delta	24A	8.6 kW	208V	(12) L6-20R	13.8A / Bank
FM412-10L	FB412-10L	L15-30P	208V 3-Phase Delta	24A	8.6 kW	208V	(36) C13	13.8A / Bank
FM432-10L	FB432-10L	L15-30P	208V 3-Phase Delta	24A	8.6 kW	208V	(24) C13; (4) C19; (4) L6-20R	13.8A / Bank
FM445-10L	FB445-10L	L15-30P	208V 3-Phase Delta	24A	8.6 kW	208V	(24) C13; (6) C19	13.8A / Bank
FM403-10L	FB403-10L	L15-30P	208V 3-Phase Delta	24A	8.6 kW	208V	(36) C13; (6) C19	13.8A / Bank
FM390-10L	FB390-10L	L21-30P	208V 3-Phase WYE	24A	8.6 kW	208V	(12) C13; (12) C19	13.8A / Bank
FM386-10L	FB386-10L	L21-30P	208V 3-Phase WYE	24A	8.6 kW	208V	(12) C13; (18) C19	13.8A / Bank
FM348-10L	FB348-10L	L21-30P	208V 3-Phase WYE	24A	8.6 kW	208V	(12) L6-20R	13.8A / Bank
FM331-10L	FB331-10L	L21-30P	208V 3-Phase WYE	24A	8.6 kW	120V & 208V	(24) C13; (3) 5-20R	13.8A / Bank
FM311-10L	FB311-10L	L21-30P	208V 3-Phase WYE	24A	8.6 kW	120V	(36) 5-20R	13.8A / Bank
FM324-10L	FB324-10L	L21-30P	208V 3-Phase WYE	24A	8.6 kW	208V	(36) C13	13.8A / Bank
FM377-10L	—	L21-30P	208V 3-Phase WYE	24A	8.6 kW	120V & 208V	(8) C13; (4) L6-20R; (12) 5-20R	13.8A / Bank
FM374-10L	FB374-10L	L21-30P	208V 3-Phase WYE	24A	8.6 kW	208V	(24) C13; (4) C19; (4) L6-20R	13.8A / Bank
FM315-10L	FB315-10L	L21-30P	208V 3-Phase WYE	24A	8.6 kW	208V	(24) C13; (6) C19	13.8A / Bank
FM380-10L	—	L21-30P	208V 3-Phase WYE	24A	8.6 kW	120V & 208V	(24) C13; (6) C19; (6) 5-20R	13.8A / Bank
FM356-10L	FB356-10L	L21-30P	208V 3-Phase WYE	24A	8.6 kW	208V	(36) C13; (6) C19	13.8A / Bank
FM434-10L	FB434-10L	460P9W	208V 3-Phase Delta	35A	12.5 kW	208V	(24) C13; (4) C19; (4) L6-20R	20A / Bank
FM424-10L	FB424-10L	460P9W	208V 3-Phase Delta	35A	12.5 kW	208V	(24) C13; (6) C19	20A / Bank
FM429-10L	FB429-10L	460P9W	208V 3-Phase Delta	35A	12.5 kW	208V	(36) C13; (6) C19	20A / Bank
FM453-10L	FB453-10L	460P9W	208V 3-Phase Delta	35A	12.5 kW	208V	(12) C13; (12) C19	20A / Bank
FM449-10L	FB449-10L	460P9W	208V 3-Phase Delta	35A	12.5 kW	208V	(12) C13; (18) C19	20A / Bank
FM428-10L	FB428-10L	460P9W	208V 3-Phase Delta	35A	12.5 kW	208V	(36) C13	20A / Bank
FM426-10L	FB426-10L	460P9W	208V 3-Phase Delta	35A	12.5 kW	208V	(12) L6-20R	20A / Bank
FM375-10L	FB375-10L	560P9W	208V 3-Phase WYE	35A	12.5 kW	208V	(24) C13; (4) C19; (4) L6-20R	20A / Bank
FM361-10L	FB361-10L	560P9W	208V 3-Phase WYE	35A	12.5 kW	208V	(24) C13; (6) C19	20A / Bank
FM381-10L	—	560P9W	208V 3-Phase WYE	35A	12.5 kW	120V & 208V	(24) C13; (6) C19; (6) 5-20R	20A / Bank
FM388-10L	FB388-10L	560P9W	208V 3-Phase WYE	35A	12.5 kW	208V	(36) C13; (6) C19	20A / Bank
FM391-10L	FB391-10L	560P9W	208V 3-Phase WYE	35A	12.5 kW	208V	(12) C13; (12) C19	20A / Bank
FM387-10L	FB387-10L	560P9W	208V 3-Phase WYE	35A	12.5 kW	208V	(12) C13; (18) C19	20A / Bank
FM371-10L	FB371-10L	560P9W	208V 3-Phase WYE	35A	12.5 kW	208V	(12) L6-20R	20A / Bank
FM367-10L	FB367-10L	560P9W	208V 3-Phase WYE	35A	12.5 kW	120V & 208V	(24) C13; (3) 5-20R	20A / Bank
FM360-10L	FB360-10L	560P9W	208V 3-Phase WYE	35A	12.5 kW	120V	(36) 5-20R	20A / Bank
FM364-10L	FB364-10L	560P9W	208V 3-Phase WYE	35A	12.5 kW	208V	(36) C13	20A / Bank
FM378-10L	—	560P9W	208V 3-Phase WYE	35A	12.5 kW	120V & 208V	(8) C13; (4) L6-20R; (12) 5-20R	20A / Bank
FM433-10L	FB433-10L	CS8365C	208V 3-Phase Delta	35A	12.5 kW	208V	(24) C13; (4) C19; (4) L6-20R	20A / Bank
FM337-10L	FB337-10L	CS8365C	208V 3-Phase Delta	35A	12.5 kW	208V	(24) C13; (6) C19	20A / Bank
FM354-10L	FB354-10L	CS8365C	208V 3-Phase Delta	35A	12.5 kW	208V	(36) C13; (6) C19	20A / Bank
FM452-10L	FB452-10L	CS8365C	208V 3-Phase Delta	35A	12.5 kW	208V	(12) C13; (12) C19	20A / Bank
FM448-10L	FB448-10L	CS8365C	208V 3-Phase Delta	35A	12.5 kW	208V	(12) C13; (18) C19	20A / Bank
FM346-10L	FB346-10L	CS8365C	208V 3-Phase Delta	35A	12.5 kW	208V	(12) L6-20R	20A / Bank
FM352-10L	FB352-10L	CS8365C	208V 3-Phase Delta	35A	12.5 kW	208V	(36) C13	20A / Bank

\* Basic = non-metered

power distribution

POWER



A, B



C



D



E



F

## SWITCHED SERIES

- Full-featured network management provided via Web, SNMP, and Telnet allows remote access, configuration, and management
- Remote individual outlet control allows shut-down of unused outlets and remote rebooting of attached equipment
- Aggregate current draw can be monitored remotely or locally via digital display
- Power sequencing minimizes in-rush current and prevents circuit overload
- SNMP alerts when power or environmental conditions exceed thresholds
- Firmware is easily upgraded via network download to installed units for future product enhancements
- External probe available separately for relative temperature and humidity monitoring; simply plug it into one of two RJ-11 ports
- Available in vertical Zero-U or horizontal rack-mount styles
- Attaches to most common cabinets and racks with included mounting hardware
- Switched Series includes all features from the Metered Series

## METERED SERIES

- Current monitoring helps prevent overloads in high-density computing environments
- Available in vertical Zero-U or horizontal rack-mount styles
- Horizontal units mount on 19" racks and cabinets
- Included mounting hardware allows attachment to most common cabinets and racks
- Optional adjustable rack-mounting bracket available for vertical units

## STANDARDS & CERTIFICATIONS

UL 60950-1  
LISTED | #E228302

## RECOMMENDED APPLICATIONS:

Data Center Cabinets  
Telecommunications  
Racks

Adjustable extension mounting brackets available; see spotlight on page D11.

# POWER DISTRIBUTION | Switched & Metered Series

## SWITCHED SERIES VERTICAL POWER DISTRIBUTION UNITS (PDUs)

PART NO.	INPUT			OUTPUT			DIMENSIONS
	VOLTAGE	AMPS	INPUT CORD TYPE, LENGTH & PLUG	VOLTAGE	RECEPTACLE TYPE	RECEPTACLE QUANTITY	
<b>[A]</b> SV161-1D1*	120V	20A	Modular Cord sold separately; see accessories below	120V	5-20R	16	44.4" L x 1.75" W x 2.25" D
<b>[B]</b> SV162-1C2	208V	30A	Hardwired; 10' w/L6-30P plug	208V	C13	16	49.5" L x 1.75" W x 2.25" D

## METERED SERIES VERTICAL POWER DISTRIBUTION UNITS (PDUs)

PART NO.	INPUT			OUTPUT			DIMENSIONS
	VOLTAGE	AMPS	INPUT CORD TYPE, LENGTH & PLUG	VOLTAGE	RECEPTACLE TYPE	RECEPTACLE QUANTITY	
MV121-1B1	120V	30A	Hardwired; 10' w/L5-30P plug	120V	5-20R	12	31.25" L x 1.75" W x 2.25" D
MV241-1D1*	120V	20A	Modular Cord sold separately; see accessories below	120V	5-20R	24	54.0" L x 1.75" W x 2.25" D
MV242-1C2	208V	30A	Hardwired; 10' w/L6-30P plug	208V	C13	24	54.0" L x 1.75" W x 2.25" D

## SWITCHED SERIES HORIZONTAL POWER DISTRIBUTION UNITS (PDUs)

PART NO.	INPUT			OUTPUT			DIMENSIONS
	VOLTAGE	AMPS	INPUT CORD TYPE, LENGTH & PLUG	VOLTAGE	RECEPTACLE TYPE	RECEPTACLE QUANTITY	
<b>[C]</b> SH081-1D1*	120V	20A	Modular Cord sold separately; see accessories below	120V	5-20R	8	1.75" H x 17" W x 7" D
<b>[D]</b> SH082-1C2	208V	30A	Hardwired; 10' w/L6-30P plug	208V	C13	8	1.75" H x 17" W x 7" D

## METERED SERIES HORIZONTAL POWER DISTRIBUTION UNITS (PDUs)

PART NO.	INPUT			OUTPUT			DIMENSIONS
	VOLTAGE	AMPS	INPUT CORD TYPE, LENGTH & PLUG	VOLTAGE	RECEPTACLE TYPE	RECEPTACLE QUANTITY	
<b>[E]</b> MH101-1D1*	120V	20A	Modular Cord sold separately; see accessories below	120V	5-20R	10	1.75" H x 17.5" W x 5" D
<b>[F]</b> MH122-1C2	208V	30A	Hardwired; 10' w/L6-30P plug	208V	C13	12	1.75" H x 17.5" W x 5" D

\* = 120V/20A PDUs require a modular power cord.

## ACCESSORIES

DESCRIPTION	PART NO.
Modular Power Cord, C19 to 5-15P, 10'	PCORD-G10
Modular Power Cord, C19 to 5-20P, 10'	PCORD-A10
Modular Power Cord, C19 to L5-20P, 10'	PCORD-H10
Temperature & Relative Humidity Probe, 10'	TCORD-010



## INPUT PLUG TYPES

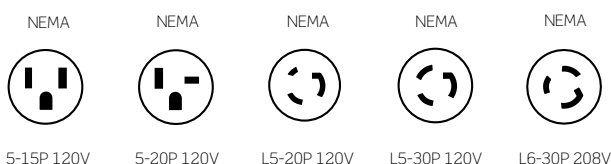

## OUTPUT RECEPTACLE TYPES

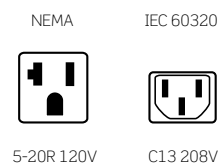

# POWER DISTRIBUTION | P1000 Series



A



B



C-E

Leviton P1000 Series Rack PDUs are designed for data centers, wiring closets, and other environments that require cost-effective, “always on” power. The robust, compact design ensures that these products can be used wherever reliability and density are important.

## P1000 SERIES

- All models feature circuit breaker protection to prevent current overloads
- Available in 120V or 208V versions with 15, 20, or 30 amps
- 208V PDUs come with 2-pole circuit breakers for added safety
- Surge-protected models prevent damage from transient surges
- LED indicators for power, grounding/polarity, and surge protection where applicable
- Hardwired power input cord
- 18-gauge cold-rolled steel construction
- Available in vertical Zero-U or horizontal 19" rack-mount styles
- Mounting hardware included; optional adjustable rack-mounting bracket available



Vertical P1000 units ship with flat brackets, L-brackets, backplates, mounting buttons, screws, and washers to support a variety of workstation options.

## STANDARDS & CERTIFICATIONS

UL 60950-1 LISTED | #E228302

UL 1449 LISTED 3RD ED. | #E228302  
(P1070 SERIES ONLY)

## RECOMMENDED APPLICATIONS:

Data Center Cabinets

Telecommunications Racks

## SPOTLIGHT

### PDU Adjustable Extension Mounting Brackets

Mount Leviton Vertical PDUs in open-frame racks with adjustable PDU Extension Mounting Brackets to make room for cable management and other hardware.

Robust 14-gauge construction ensures ample support for the PDU and attached power cords. The PDU Extension Mounting Bracket (PDURK-BKT) works with all Leviton vertical PDUs including FLX, Switched, Metered, and P1000 Series.

See ordering information on page D5.



## UNMETERED HORIZONTAL POWER DISTRIBUTION UNITS (PDUs), SINGLE INPUT

PART NO.	INPUT				OUTPUT			DIMENSIONS
	VOLTAGE	AMPS	CORD LENGTH	PLUG TYPE	VOLTAGE	RECEPTACLE TYPE	RECEPTACLE QUANTITY	
P1020-12S	120V	15A	12'	5-15P	120V	5-15R	10	1.75" H x 17.5" W x 4.5" D
<b>[A]</b> P1021-12S	120V	20A	12'	5-20P	120V	5-20R	10	1.75" H x 17.5" W x 4.5" D
P1022-12L	120V	20A	12'	L5-20P	120V	5-20R	10	1.75" H x 17.5" W x 4.5" D
P1023-12L	120V	30A	12'	L5-30P	120V	5-20R	16	3.5" H x 17.5" W x 4.5" D
<b>[B]</b> P1024-12L	208V	20A	12'	L6-20P	208V	C13	12	1.75" H x 17.5" W x 4.5" D
P1025-12L	208V	30A	12'	L6-30P	208V	C13	16	3.5" H x 17.5" W x 4.5" D

## UNMETERED VERTICAL POWER DISTRIBUTION UNITS (PDUs), SINGLE INPUT

PART NO.	INPUT				OUTPUT			DIMENSIONS
	VOLTAGE	AMPS	CORD LENGTH	PLUG TYPE	VOLTAGE	RECEPTACLE TYPE	RECEPTACLE QUANTITY	
P1040-10S	120V	15A	10'	5-15P	120V	5-15R	16	30" L x 1.8" W x 1.75" D
<b>[C]</b> P1041-10S	120V	20A	10'	5-20P	120V	5-20R	16	30" L x 1.8" W x 1.75" D
P1042-10L	120V	20A	10'	L5-20P	120V	5-20R	16	30" L x 1.8" W x 1.75" D
P1043-10S	120V	20A	10'	5-20P	120V	5-20R	24	48" L x 1.8" W x 1.75" D
<b>[D]</b> P1044-10L	120V	20A	10'	L5-20P	120V	5-20R	24	48" L x 1.8" W x 1.75" D
P1045-10L	120V	30A	10'	L5-30P	120V	5-20R	24	48" L x 1.8" W x 1.75" D
P1046-10L	208V	20A	10'	L6-20P	208V	C13	24	48" L x 2.19" W x 2" D
<b>[E]</b> P1047-10L	208V	30A	10'	L6-30P	208V	C13	24	48" L x 2.19" W x 2" D

## SURGE-PROTECTED VERTICAL POWER DISTRIBUTION UNITS (PDUs), SINGLE INPUT

PART NO.	INPUT				OUTPUT			DIMENSIONS
	VOLTAGE	AMPS	CORD LENGTH	PLUG TYPE	VOLTAGE	RECEPTACLE TYPE	RECEPTACLE QUANTITY	
P1070-10S	120V	15A	10'	5-15P	120V	5-15R	16	30" L x 2.19" W x 1.73" D
P1071-10S	120V	20A	10'	5-20P	120V	5-20R	16	30" L x 2.19" W x 1.73" D
P1072-10L	120V	20A	10'	L5-20P	120V	5-20R	16	30" L x 2.19" W x 1.73" D
P1073-10S	120V	20A	10'	5-20P	120V	5-20R	24	48" L x 2.19" W x 1.73" D
P1074-10L	120V	20A	10'	L5-20P	120V	5-20R	24	48" L x 2.19" W x 1.73" D

All P1000 Series PDUs have hard-wired cords.

### INPUT PLUG TYPES

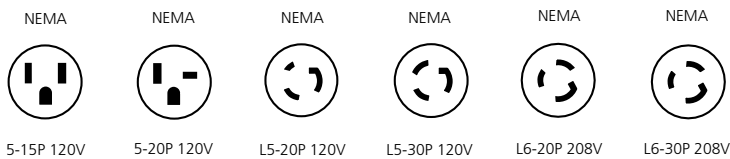

### OUTPUT RECEPTACLE TYPES

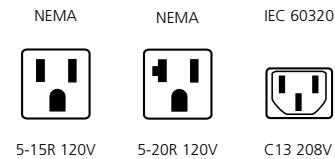

power distribution

POWER

# POWER DISTRIBUTION | 5500 & 5505 Series



A



B

Leviton 5500 and 5505 Series Power Distribution Units (PDUs) help power and protect vital electronic equipment. These PDUs are similar to the 4500 Series, but with the added assurance of surge protection. The 5500 and 5505 Series share several key features, including:

- Resettable circuit breaker to protect against overloading
- 12 receptacles: 10 in back, 2 in front
- 20-amp versions available with either straight blade or locking input plug
- Mounts horizontally on 19" racks or cabinets

## STANDARDS & CERTIFICATIONS

UL 1363 RECOGNIZED | #E118936

5500: UL 1449 LISTED 3RD ED. | #E118936/3/1

5505: UL 1449 LISTED 3RD ED. | #E118936/3/2

## 5500 SERIES W/ ENHANCED SURGE PROTECTION

- Peak surge current: 72 kA
- VPR — L-N: 400 Vpk, L-G/N-G: 500 Vpk
- EMI/RFI noise filtering: 100 kHz to 30 MHz, -10 dB to -35 dB
- Type SPD: 4
- Physical dimensions: 1.75" H x 19" W x 4.55" D

## 5505 SERIES W/ SURGE PROTECTION

- Peak surge current: 27 kA
- VPR — L-N: 600 Vpk, L-G/N-G: 700 Vpk
- EMI/RFI noise filtering: 100 kHz to 30 MHz, -5 dB to -40 dB
- Type SPD: 4
- Physical dimensions: 1.75" H x 19" W x 2.5" D

## 5500/5505 SERIES RACK-MOUNT POWER DISTRIBUTION UNITS (PDUs) WITH SURGE PROTECTION

PART NO.	FOOTPRINT	ON/OFF SWITCH		INPUT				OUTPUT		
		YES	NO	INPUT VOLTAGE	AMPS	CORD LENGTH	INPUT PLUG	OUTPUT VOLTAGE	RECEPTACLE TYPE	RECEPTACLE QUANTITY
[A] 5500-190	Horizontal / Rack Mnt.	•		120V	15A	12'	5-15P	120V	5-15R	12
5500-192	Horizontal / Rack Mnt.	•		120V	20A	12'	5-20P	120V	5-20R	12
5500-20L	Horizontal / Rack Mnt.	•		120V	20A	12'	L5-20P	120V	5-20R	12
5500-15N	Horizontal / Rack Mnt.		•	120V	15A	12'	5-15P	120V	5-15R	12
[B] 5500-20N	Horizontal / Rack Mnt.		•	120V	20A	12'	5-20P	120V	5-20R	12
5500-2NL	Horizontal / Rack Mnt.		•	120V	20A	12'	L5-20P	120V	5-20R	12
5505-190	Horizontal / Rack Mnt.	•		120V	15A	12'	5-15P	120V	5-15R	12

## INPUT PLUG TYPES

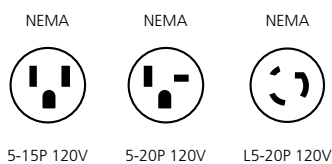

## OUTPUT RECEPTACLE TYPES

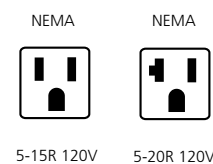





Leviton 4500 Series Power Distribution Units (PDUs) provide the robust and economical solutions needed to power vital electronic equipment. Similar to the 5500 series, but without surge protection, the 4500 Series offers flexibility and economy for use in diverse applications.

**4500 SERIES**

- Resettable circuit breaker provides overload protection
- 12 receptacles: 10 in back, 2 in front
- Available in 15- or 20-amp versions
- 20-amp versions available with either straight blade or locking input plug
- Easy-access on/off rocker switch
- Mounts horizontally on 19" racks or cabinets
- Physical dimensions: 1.75" H x 19" W x 3" D

**STANDARDS & CERTIFICATIONS**

UL 1363 RECOGNIZED | #E118936  
 UL 60950-1 LISTED | #E228302

**RECOMMENDED APPLICATIONS:  
 (5500/5505/4500)**

Telecommunications Racks

4500 SERIES RACK-MOUNT POWER DISTRIBUTION UNITS (PDUs)										
PART NO.	FOOTPRINT	ON/OFF SWITCH		INPUT			OUTPUT			
		YES	NO	INPUT VOLTAGE	AMPS	CORD LENGTH	INPUT PLUG	OUTPUT VOLTAGE	RECEPTACLE TYPE	RECEPTACLE QUANTITY
4515-07S	Horizontal / Rack Mnt.	•		120V	15A	7'	5-15P	120V	5-15R	12
<b>[A]</b> 4515-10S	Horizontal / Rack Mnt.	•		120V	15A	10'	5-15P	120V	5-15R	12
4515-15S	Horizontal / Rack Mnt.	•		120V	15A	15'	5-15P	120V	5-15R	12
4520-07S	Horizontal / Rack Mnt.	•		120V	20A	7'	5-20P	120V	5-20R	12
<b>[B]</b> 4520-10S	Horizontal / Rack Mnt.	•		120V	20A	10'	5-20P	120V	5-20R	12
4520-15S	Horizontal / Rack Mnt.	•		120V	20A	15'	5-20P	120V	5-20R	12
4520-07L*	Horizontal / Rack Mnt.	•		120V	20A	7'	L5-20P	120V	5-20R	12
4520-10L*	Horizontal / Rack Mnt.	•		120V	20A	10'	L5-20P	120V	5-20R	12
4520-15L*	Horizontal / Rack Mnt.	•		120V	20A	15'	L5-20P	120V	5-20R	12

\* 4520-07L formerly 4505-20L; 4520-10L formerly 4505-20T; 4520-15L formerly 4505-20F.

**INPUT PLUG TYPES**

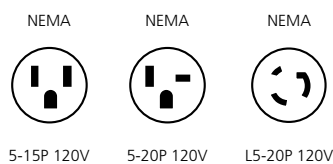

**OUTPUT RECEPTACLE TYPES**

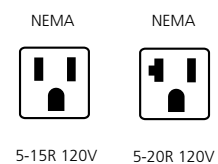

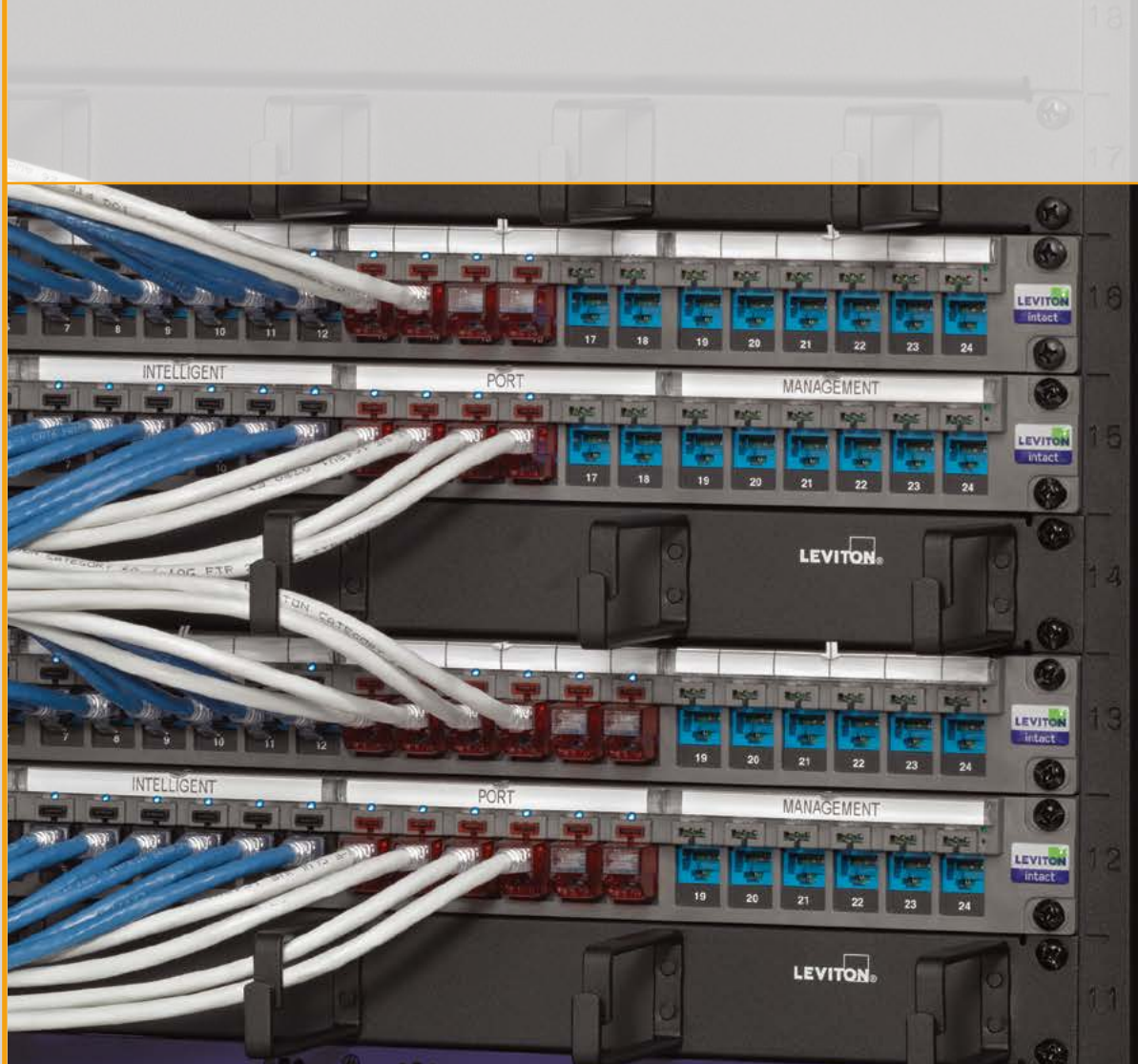

# MANAGED SOLUTIONS

SECTION



---

## SECTION E CONTENTS

<b>INTACT™</b>	<b>E3</b>	Introduction
<b>INTELLIGENT PORT MANAGEMENT SYSTEM</b>	<b>E4</b>	Software & Hardware
	<b>E5</b>	System Components
	<b>E6</b>	Patch Cords & Port Blockers



## INTACT INTELLIGENT PORT MANAGEMENT SYSTEM

The Intact Intelligent Port Management System offers a simple, straightforward way to manage network changes. It provides real-time network documentation with alerts for faults or unplanned changes to ports. By focusing on the core change management processes used every day, Intact reduces the complexity found in other systems.

- Receive and maintain accurate, up-to-date network documentation
- Identify and diagnose problems faster, reducing downtime and risk of human error
- Assist technicians through changes and troubleshooting by managing work orders, logging events, and creating visual network topologies

## HOW INTACT WORKS



A microchip is attached to the Intact **Patch Cord** plug, programmed with information unique to each cord.



Intact **Intelligent Panels** monitor port status and communicate with the Intact Device Manager.



The **Device Manager** hosts the pre-installed Intact Software. Multiple Device Managers operate together seamlessly for larger systems.



Intact **Software** is accessed from the corporate network using Web browsers, including those on tablets and smartphones.



**SOFTWARE**

Intact software comes pre-loaded on the Device Manager, so there's no set-up or configuring. It can be accessed on any Web browser over the corporate network, including mobile devices like tablets or smartphones. The software manages work orders, event logging, and visual network topology to assist technicians and IT managers through moves, adds, changes, and troubleshooting.

**HARDWARE**

The Intact system is available for both copper and optical fiber networks. Standard Leviton patch panels and enclosures can easily be upgraded to Intact intelligent panels, and Intact copper and fiber patch cords are also based on existing standard product designs. The added intelligent technology allows the system to monitor the connection status of ports.

Intact is the only system to provide an extra layer of security, with the ability to lock in patch cords and lock out unused ports. Once plugged in, Intact Secure copper and fiber patch cords can only be removed with a matching-color extraction tool, deterring any unauthorized access.

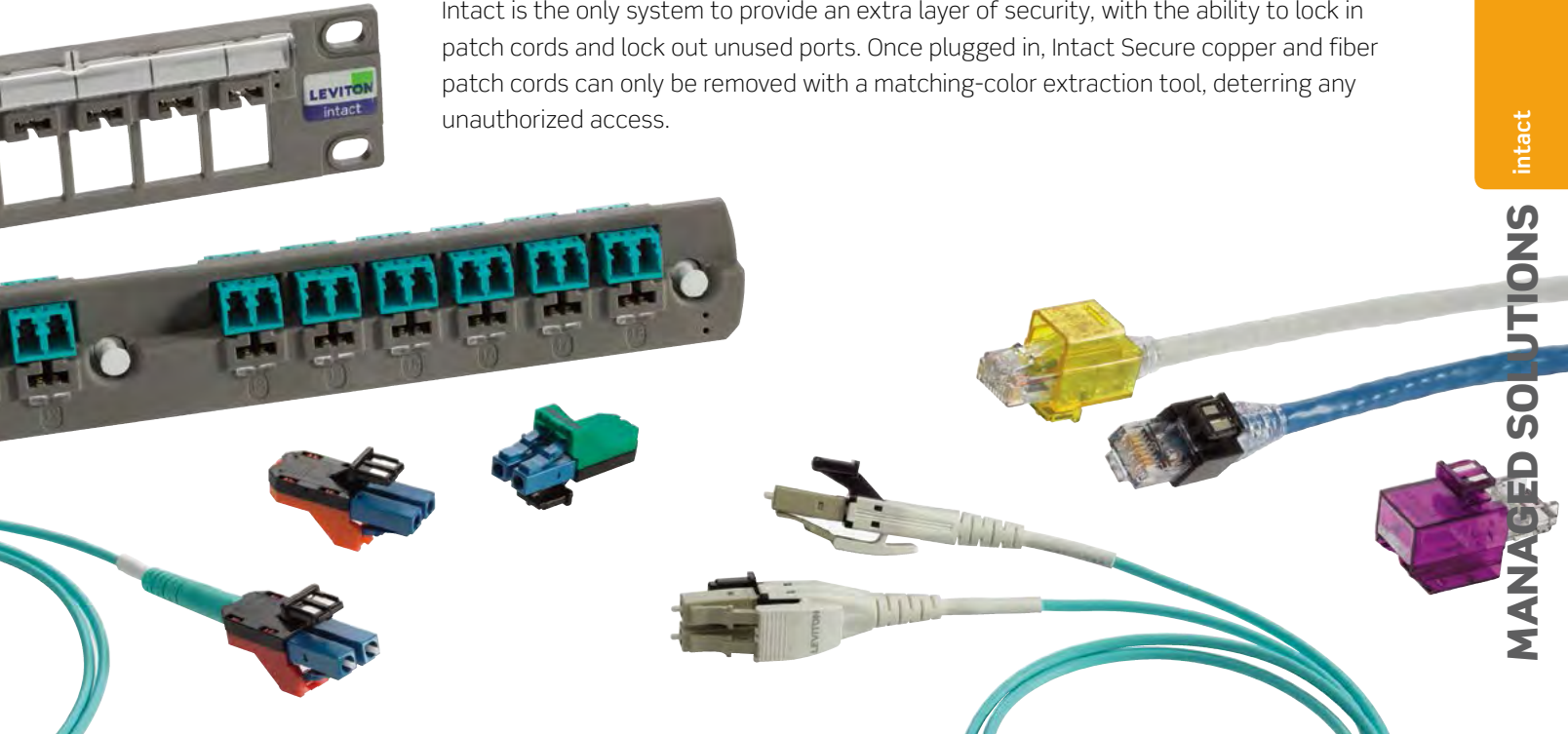

MANAGED SOLUTIONS

# INTACT™ | System Components



## FEATURES

- Intact Intelligent Panels send network port status back to the Intact Device Manager, a 1RU Ethernet-enabled controller that hosts the system software
- During work orders and when alarms occur, LED lights provide guidance above affected ports on the panel
- Using Intact Device Hubs, one Device Manager can expand to support over 100 Intact panels
- Multiple Device Managers operate seamlessly, allowing systems to scale easily
- QuickPort® copper panels (1RU, 24-port) and Opt-X Ultra® fiber enclosures (1RU, 2RU) are “intelligent-ready” and can be upgraded to become an Intact intelligent device while remaining on the rack
- Panels and enclosures can be upgraded without removing connectors, preserving the integrity of permanent link testing



## INTACT INTELLIGENT PORT MANAGEMENT SYSTEM COMPONENTS

DESCRIPTION	PART NO.
[A] Intact QuickPort Patch Panel Upgrade Kit, 24-port*	4MKIT-F24
[B] Intact Opt-X Ultra Fiber Upgrade Kit, 36-fiber, Aqua MM LC duplex adapters included*	5RKIT-OM3
[C] Intact Opt-X Ultra Fiber Upgrade Kit, 36-fiber, Blue SM LC duplex adapters included*	5RKIT-OS2
[D] Opt-X Ultra 1RU Enclosure (Intelligent-Ready), empty	5R1UH-S03
[E] Opt-X Ultra 2RU Enclosure (Intelligent-Ready), empty	5R2UH-S06
[F] Flat QuickPort® Patch Panel (Intelligent-Ready), 1RU, 24-port, empty	49255-H24
[G] Intact Device Manager, 1RU, software and C13 to 5-15P power cord included	4MSYS-IDM
[H] Intact Device Hub, includes power supply adapter with U.S. and Euro plug options and 2-meter USB cable	4MSYS-IDH
[I] Intact Device Hub Mounting Bracket	4MSYS-BKT

\* = QuickPort panels and Fiber Enclosures are sold separately.

## Make to order! INTACT COPPER & INTACT SECURE RJ COPPER PATCH CORD OPTIONS

CORD TYPE	SECURE HOUSING COLOR	CABLE COLOR	CABLE TYPE	HOUSING PLACEMENT	CABLE LENGTH
<ul style="list-style-type: none"> <li>• Intact</li> <li>• Intact Secure</li> </ul>	<ul style="list-style-type: none"> <li>• Transparent White</li> <li>• Transparent Yellow</li> <li>• Transparent Orange</li> <li>• Transparent Red</li> <li>• Transparent Blue</li> <li>• Transparent Green</li> <li>• Transparent Black</li> <li>• Transparent Purple</li> </ul>	<ul style="list-style-type: none"> <li>• White</li> <li>• Yellow</li> <li>• Red</li> <li>• Blue</li> <li>• Green</li> <li>• Grey</li> <li>• Black</li> </ul>	<ul style="list-style-type: none"> <li>• CAT 6A FTP CM</li> <li>• CAT 6 UTP CM</li> </ul>	<b>FIRST END</b> <ul style="list-style-type: none"> <li>• Intact</li> <li>• Intact Secure RJ</li> </ul> <b>SECOND END</b> <ul style="list-style-type: none"> <li>• Intact</li> <li>• Intact Secure RJ</li> <li>• Secure RJ</li> </ul>	<ul style="list-style-type: none"> <li>• 3-72 Feet</li> <li>• 1-22 Meters</li> </ul>



For assistance customizing your patch cords, please visit [leviton.com/configurator](http://leviton.com/configurator) or call Tech Support at 800.824.3005.

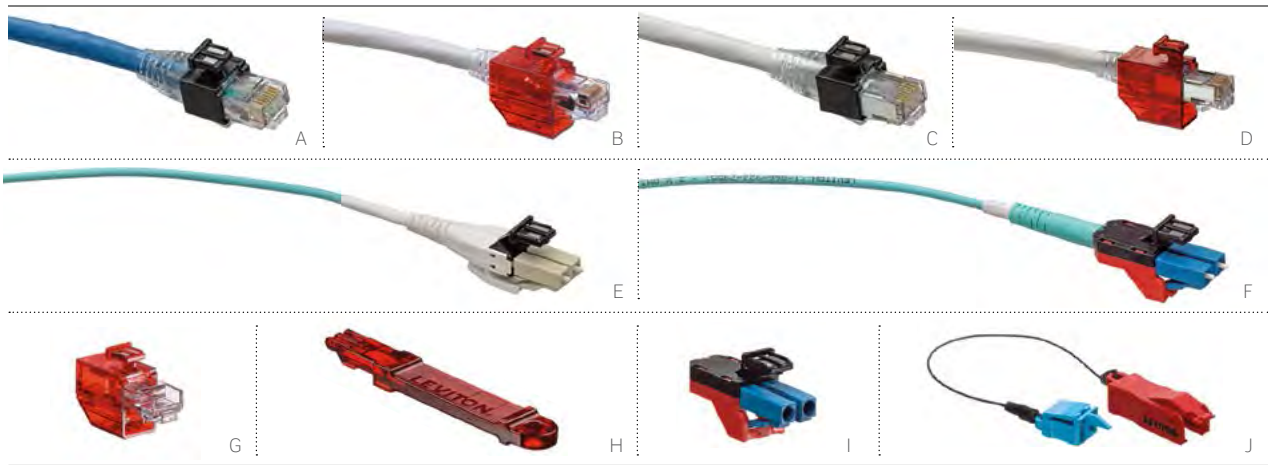

**PATCH CORD FEATURES**

- Intact CAT 6 and 6A RJ patch cords are independently tested and verified by Intertek (ETL) for component performance
- Intact fiber patch cords are available in OM4, OM3, OM2, OM1, and OS2
- Intact Secure RJ and LC cords include a patented locking mechanism that cannot be released without a matching-color extraction tool
- Intact Secure Port Blockers prevent unauthorized port access and enable ports to be reserved for future use
- Patch cord insertion loss and return loss tested to industry-leading standards for both copper and fiber



**INTACT INTELLIGENT PATCH CORDS & PORT BLOCKERS**

DESCRIPTION	PART NO.
[A] Intact CAT 6 Copper Patch Cord	
[B] Intact Secure CAT 6 Copper Patch Cord	
[C] Intact CAT 6A Copper Patch Cord	
[D] Intact Secure CAT 6A Copper Patch Cord	
[E] Intact Fiber Patch Cord	
[F] Intact Secure Fiber Patch Cord	
[G] Intact Secure RJ Port Blocker	MRJPB-00*
[H] Secure RJ Extraction Tool	SRJET-00*
[I] Intact Secure LC Port Blocker	MLCPB-^LG
[J] Secure LC Extraction Tool with Dust Cap	ETRTRN-^TL

Customize your patch cords at [leviton.com/configurator](http://leviton.com/configurator)

\* = Secure RJ Colors (transparent):

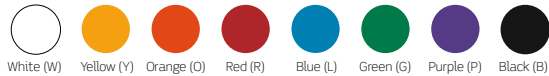

^ = Secure LC Colors:

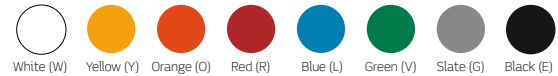

**Make to order! INTACT FIBER & INTACT SECURE LC FIBER PATCH CORD OPTIONS**

FIBER TYPE	KEYED COLOR	CABLE TYPE / POLARITY	TERMINATION	CABLE LENGTH
<ul style="list-style-type: none"> <li>• OM1</li> <li>• OM2</li> <li>• OM3</li> <li>• OM4</li> <li>• OS2</li> </ul>	<ul style="list-style-type: none"> <li>• White</li> <li>• Yellow</li> <li>• Orange</li> <li>• Red</li> <li>• Blue</li> <li>• Green</li> <li>• Slate</li> <li>• Black</li> </ul>	<ul style="list-style-type: none"> <li>• Duplex Riser-Rated A to B Polarity</li> <li>• Duplex Plenum-Rated A to B Polarity</li> <li>• Duplex Riser-Rated A to A Polarity</li> <li>• Duplex Plenum-Rated A to A Polarity</li> </ul>	<p><b>FIRST END</b></p> <ul style="list-style-type: none"> <li>• Intact Duplex LC (uniboot)</li> <li>• Intact Secure Duplex LC (uniboot)</li> </ul> <p><b>SECOND END</b></p> <ul style="list-style-type: none"> <li>• Intact Duplex LC (uniboot)</li> <li>• Intact Secure Duplex LC (uniboot)</li> <li>• Secure Duplex LC (uniboot)</li> <li>• Duplex LC (uniboot)</li> </ul>	<ul style="list-style-type: none"> <li>• 1-22 Meters</li> </ul>

For assistance customizing your patch cords, please visit [leviton.com/configurator](http://leviton.com/configurator) or call Tech Support at 800.824.3005.



SECTION  
F

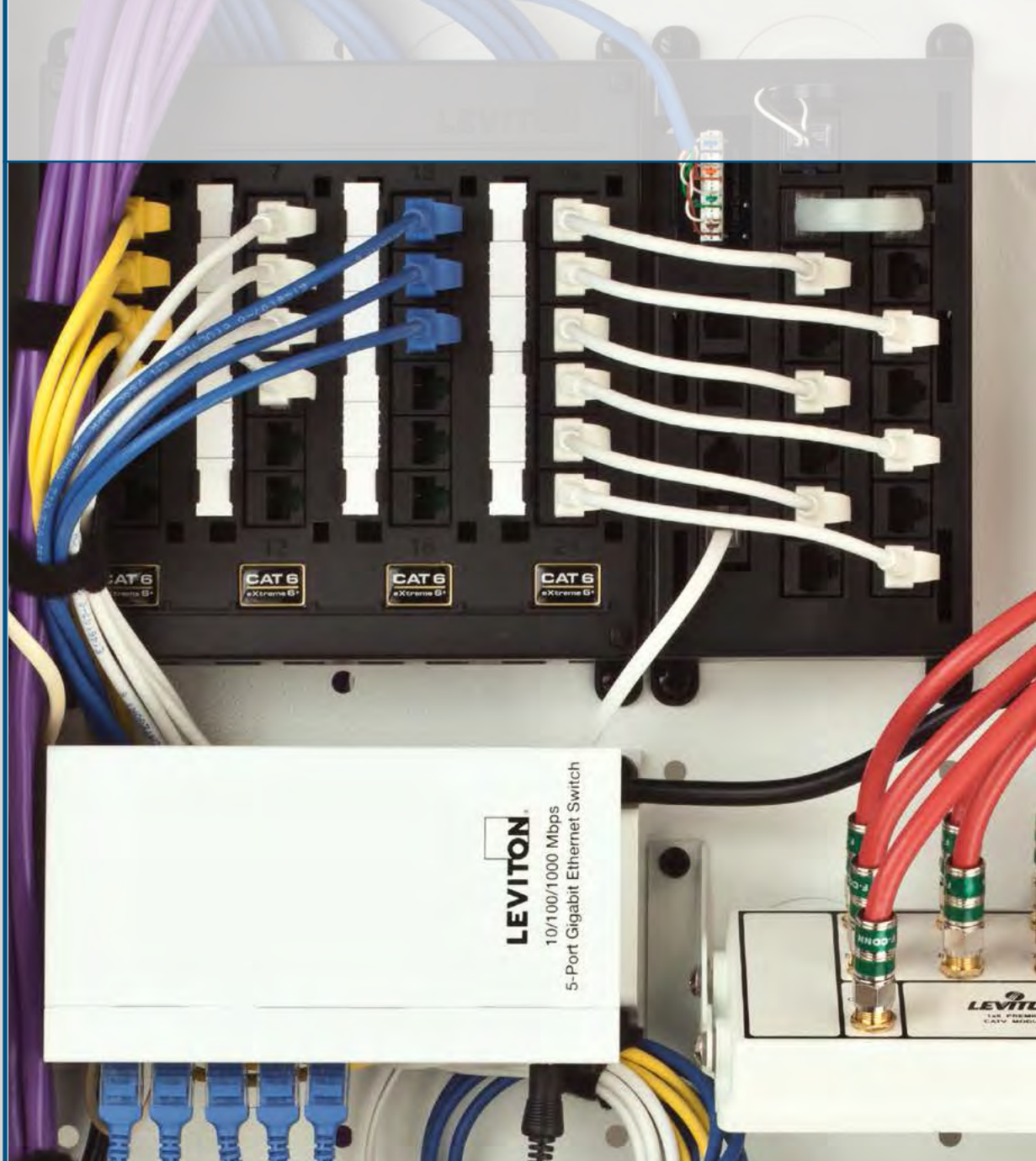

MDU SOLUTIONS





---

## SECTION F CONTENTS

MULTIPLE DWELLING UNITS (MDU) SYSTEMS	<b>F3</b>	The Connected Home Network
	<b>F5</b>	Populating the Structured Media® Enclosure
STRUCTURED MEDIA	<b>F7</b>	Structured Media Enclosures
	<b>F11</b>	Concrete-Mountable Structured Media & RF Transparent Enclosures
	<b>F12</b>	Fiber-to-the-Home (FTTH) Solutions
	<b>F13</b>	Routers & Switches
	<b>F14</b>	Power Supplies & Surge Protection
	<b>F15</b>	Mounting Brackets & Patch Cords
	<b>F16</b>	Mounting Brackets & Tools
	<b>F17</b>	Twist & Mount Patch Panels
	<b>F17</b>	Telephone Input Distribution Panels (TIDP)
	<b>F17</b>	Compact Series Structured Media Panels
	<b>F18</b>	Standard Series Structured Media Panels
	<b>F19</b>	Modules & Expansion Boards
	<b>F21</b>	Video Distribution & Splitters
	<b>F22</b>	Data & A/V Connectors
	<b>F23</b>	Renu® Wallplates & Inserts
	<b>F24</b>	QuickPort® Wallplates
	<b>F25</b>	Decora® Wallplates & Inserts
	<b>F26</b>	Cheetah Speed System®
AUDIO	<b>F27</b>	In-Wall/Ceiling & Outdoor Speakers
	<b>F29</b>	Home Theater Speakers
	<b>F30</b>	Volume Controls & Audio Distribution Modules
	<b>F31</b>	Home Theater & Recessed Devices

# MDU SYSTEMS | The Connected Home

Want to increase occupancy rates and have the preferred property in the neighborhood? Make it easy for your customers to connect to the world of information, commerce, entertainment, and one another. That's where Leviton comes in, offering data, voice, audio, and video network service solutions to exceed your customers' expectations.

## MDU PROJECTS ARE ONE OF THE FASTEST-GROWING CONSTRUCTION MARKETS TODAY

### Apartments and Condos

Welcome to renter nation. Two-thirds of all new households formed in the next five years will be renters. Surround your tenants with technology; make it easy for them to connect.

### Hotels and Hospitality

Expectations for hotel technology are the same, if not greater, than at home. Create a home-like atmosphere for business travelers and vacationers alike with audio, video, and high-speed Internet connectivity.

### Hospitals and Health Care

Hospital technology is more than medical treatment. It's also the comfort and connectivity provided by familiar things like HDTV and high-speed Internet. Leviton systems are the value add that can differentiate your projects in the market.

### Mixed-Use Buildings

Urban infill is in, putting residential, retail, and commercial in a shared building. A connected building can be the difference that attracts business and residential tenants. Leviton's enterprise-grade connectivity systems are the whole building solution to serve your commercial and residential consumers.



the connected home

MDU

Leviton is providing contractors, developers, and integrators cost-effective solutions to stand out in the MDU market. Our market-leading residential and commercial structured wiring systems deliver the highest performance voice, audio, video, and data networks available.



### Internet Connectivity

Voice, data, audio, and video ports support VoIP, IPTV, HDTV, Blu-ray™, and streaming music and movies

### High-Speed Gaming

Online games and multi-player experience with less lag time

### System Security

Structured wiring offers better network security than wireless

### Integrated Home Theater

State-of-the-art distribution, speakers, and control modules bring the movie theater experience home

### Multiroom Audio

A single playlist can be enjoyed in any connected room

### Empowered Wi-Fi®

A wireless network within a structured wiring system provides high-speed connectivity and convenience



## OPTIMIZING A HOME NETWORK

### Wire Up for Speed, Security, and Reliability

Only a wired connection can deliver gigabit performance. Wire up gaming consoles, IPTVs, set-top boxes, and any other stationary appliances for the best possible performance, data security, and signal reliability.

### Go Wireless for Convenience and Mobility

Wireless provides convenient broadband access for mobile devices. Leviton has developed an innovative and comprehensive suite of structured wiring products that include gigabit networking, integrated Wi-Fi, and RF-transparent solutions.

## POPULATING THE STRUCTURED MEDIA ENCLOSURE - THE NERVE CENTER OF THE CONNECTED HOME

Get enterprise-grade, best-in-class broadband network performance capability with Leviton Connected Home components. All Structured Media solutions are engineered to work together, providing a clean and organized base and simplifying integration from rough-in through line activation.

1

### Structured Media Enclosures

These versatile enclosures allow you to manage and distribute a full range of voice, data, audio, and video wiring from one central location. We have enclosure solutions for wood frame, concrete, and cinder block construction.



2

### Data Patching and Distribution

Leviton offers durable CAT 6 and 5e panels and modules for data cable distribution. The high-end Twist & Mount Panel makes installation easy and provides easy access for moves, additions, or changes in the home network.

3

### Telephone Patching and Distribution

Choose from a wide selection of telephone distribution boards, modules, or panels for the secure feel and sound of a telephone landline. Our Telephone Input Distribution Panel (TIDP) supports inputs for use with “triple play” modems and complements the look and simplicity of our Twist & Mount Patch Panels.





4

## Internet Routers and Switches

Leviton has high-speed routers to share Internet access over a Wide Area Network (WAN) in the home or office, and Ethernet switches to network additional PCs, printers, and other peripherals beyond router capacity.

6

## Ultra High-Flex Patch Cords

The structured cabling system you install today will likely change tomorrow. Ultra High-Flex Patch Cords help make changes easy. They allow for tighter radius connections and a cleaner finished appearance inside a dressed Structured Media Enclosure.



8

## Integrated Power Supply

Structured cabling systems rely on active gear that requires low-voltage power and surge protection. Leviton offers power supplies with extra plugs that eliminate the need for bulky power adapters within enclosures.



5

## Premium and Passive CATV Splitters

Distribute the incoming RF signal to locations throughout a home via coaxial cable using Leviton's passive CATV splitters, or use Premium splitters to optimize the performance of digital cable signals to handle HDTV. The Premium splitter's forward-path internal amplifier provides equal input and output levels on all ports.



7

## Multi-Room Audio

The Hi-Fi 2 Four Source, Four Zone (4x4) is a quality distributed audio system that integrates easily inside a Structured Media enclosure. It is ideal for controlling, sharing, and listening to audio systems throughout the home. More information on the Hi-Fi 4x4 system is available online at [leviton.com/hifi4x4](http://leviton.com/hifi4x4).



9

## ISP Modem (provided by service provider)

The modem converts DSL, cable, or fiber optic signals for Internet access for triple-play service or pure data connections.





Leviton Structured Media Enclosures provide a convenient termination location for wiring home runs from wall outlets, creating a distribution point for voice, data, audio, and video applications. Available in compact, 14", 21", 28", and 42" sizes to address a broad range of capacities for single family homes, MDUs, and light commercial applications, Leviton Structured Media Enclosures support new and retrofit installations.

## STRUCTURED MEDIA ENCLOSURES, COVERS & DOORS

- Enclosures are constructed of white powder-coated 20-gauge steel
- Covers and doors are constructed of white powder-coated 18-gauge steel, and feature 3/4" overlap to hide irregular drywall cuts
- Modules mount vertically or horizontally
- Multiple knock-outs on top and bottom facilitate cable entry and routing
- Knock-out in base of enclosure accommodates single- and double-gang J-boxes and power modules
- Six 3" self-healing foam grommets included to accommodate and protect cable bundles
- Can be surface mounted or recessed
- Mounting tabs on housing sidewalls prevent enclosure from falling through the studs during installation
- Combine two or more enclosures for larger installations or future expansion
- Optional lock and key set available for additional security
- Standards compliance: ACA and cULus Listed
- For enclosure configuration assistance, go to [leviton.com/homeconfig](http://leviton.com/homeconfig)
- ANSI/UL 1863 - Communication Circuit Accessories
- ANSI/UL 985 - Household Fire-Warning System Units
- ANSI/UL 1023 - Household Burglar-Alarm System Units

**14" & 21" ENCLOSURES, COVERS & DOORS**

- Entry-level home network enclosures create a central distribution point for low-voltage cabling
- Ideal for apartments, condos, and smaller homes
- 14" enclosure accommodates basic residential networking systems and accessories
- 21" enclosure provides additional room for larger modules and equipment

**COMPACT STRUCTURED MEDIA MDU ENCLOSURES**

- Economical solution for MDU connectivity
- Flexibility to accommodate a variety of telephone/video distribution configurations
- Available empty with cover or in two pre-configured kits
- Snap-on cover requires no tools or fasteners
- Molded-in brackets provide quick snap-in convenience for expansion boards
- Angled video-splitter shelf for easy installation
- Hosts three expansion boards and one TV splitter
- Constructed of sturdy white ABS molded plastic
- cULus Listed for communications equipment

14" STRUCTURED MEDIA ENCLOSURES, COVERS & DOORS	
DESCRIPTION	PART NO.
14" Enclosure and Flush-Mount Cover, 15.32" (389.1 mm) H x 15.62" (396.7 mm) W x 3.83" (97.3 mm) D	47605-140
<b>[A]</b> 14" Enclosure, 14.0" (355.6 mm) H x 14.38" (365.3 mm) W x 3.63" (92.2 mm) D	47605-14E
14" Multi-Dwelling Unit Configuration A, Enclosure and Flush-Mount Cover, 15.32" (389.1 mm) H x 15.62" (396.7 mm) W x 3.83" (97.3 mm) D (see page F10 for knock-out configurations)	47605-1MG
<b>[B]</b> 14" Flush-Mount Cover, 15.32" (389.1 mm) H x 15.62" (396.7 mm) W x 0.20" (5.1 mm) D	47605-14C
<b>[C]</b> 14" Economy Hinged Door, 15.32" (389.1 mm) H x 15.62" (396.7 mm) W x 0.25" (6.4 mm) D	47605-14D
14" Premium Hinged Door, 15.32" (389.1 mm) H x 15.62" (396.7 mm) W x 0.25" (6.4 mm) D	47605-14P
14" Premium Vented Hinged Door, 15.32" (389.1 mm) H x 15.62" (396.7 mm) W x 0.25" (6.4 mm) D	47605-14S
14" Enclosure, job packed, 6 per pack, 14.0" (355.6 mm) H x 14.38" (365.3 mm) W x 3.63" (92.2 mm) D	47605-14G
14" Flush-Mount Cover, job packed, 6 per pack, 15.32" (389.1 mm) H x 15.62" (396.7 mm) W x 0.20" (5.1 mm) D	47605-14B
Structured Media Enclosure Lock & Key for 14", 21", 28", and 42" hinged doors	5L000-L0K
21" STRUCTURED MEDIA ENCLOSURES, COVERS & DOORS	
<b>[D]</b> 21" Enclosure, 21.0" (533.4 mm) H x 14.38" (365.3 mm) W x 3.63" (92.2 mm) D	47605-21E
<b>[E]</b> 21" Flush-Mount Cover, 22.35" (567.7 mm) H x 15.62" (396.7 mm) W x 0.20" (5.1 mm) D	47605-21C
<b>[F]</b> 21" Premium Vented Hinged Door, 22.35" (567.7 mm) H x 15.62" (396.7 mm) W x 0.25" (6.4 mm) D	47605-21S
Structured Media Enclosure Lock & Key for 14", 21", 28", and 42" hinged doors	5L000-L0K
COMPACT STRUCTURED MEDIA MDU ENCLOSURES	
<b>[G]</b> Compact Structured Media Enclosure and Cover, empty, 8.02" (203.7 mm) H x 14.38" (365.2 mm) W x 3.71" (94.2 mm) D	47605-MDU
Compact Structured Media Enclosure Cover only, 15.375" (390.5 mm) H x 9" (228.6 mm) W x .5" (12.7 mm) D	47605-MDC
<b>[H]</b> MDU Kit (Compact Structured Media Enclosure and Cover plus 1x6 Telephone Expansion Board), 8.02" (203.7 mm) H x 14.38" (365.2 mm) W x 3.71" (94.2 mm) D	47604-0F6
<b>[I]</b> MDU Kit (Compact Structured Media Enclosure and Cover plus 1x6 Telephone Expansion Board and 6-Way 1 GHz Splitter), 8.02" (203.7 mm) H x 14.38" (365.2 mm) W x 3.71" (94.2 mm) D	47604-F6S

structured media enclosures

MDU



**28" & 42" ENCLOSURES, COVERS & DOORS**

- Command central for virtually all technology, including networking, DSL, cable Internet modem, satellite video, security, VoIP, fax, telephone, intercom, and audio
- Available in MDU and mixed-use configurations
- 28" enclosure accommodates up to 8 distribution modules
- 42" enclosure accommodates up to 12 distribution modules

structured media enclosures

**SPOTLIGHT** Choosing Your Structured Media Enclosure Cover or Door

MDU

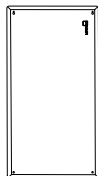

**Flush-Mount Cover**  
Screws directly to enclosure frame.

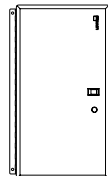

**Economy Hinged Door**  
Hinged flange attaches to left or right side of enclosure.

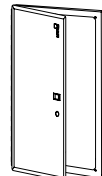

**Premium Hinged Door**  
Full-frame design adds durability and security. Door hinges from left or right.

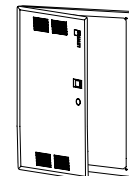

**Premium Vented Hinged Door**  
Full-frame design. Vented door hinges from left or right.



## 28" STRUCTURED MEDIA ENCLOSURES, COVERS & DOORS

DESCRIPTION	PART NO.
28" Enclosure and Flush-Mount Cover, 29.32" (744.7 mm) H x 15.62" (396.7 mm) W x 3.83" (97.3 mm) D	47605-28W
<b>[A]</b> 28" Enclosure, 28.0" (711.2 mm) H x 14.38" (365.3 mm) W x 3.63" (92.2 mm) D	47605-28N
28" Multi-Dwelling Unit Configuration A, Enclosure and Flush-Mount Cover, 29.32" (744.7 mm) H x 15.62" (396.7 mm) W x 3.83" (97.3 mm) D*	47605-2MG
28" Multi-Dwelling Unit Configuration B, Enclosure only, 28.0" (711.2 mm) H x 14.38" (365.3 mm) W x 3.63" (92.2 mm) D*	47605-M28
28" Flush-Mount Cover, 29.32" (744.7 mm) H x 15.62" (396.7 mm) W x 0.20" (5.1 mm) D	47605-F28
28" Economy Hinged Door, 29.32" (744.7 mm) H x 15.62" (396.7 mm) W x 0.25" (6.4 mm) D	47605-28D
<b>[B]</b> 28" Premium Hinged Door, 29.32" (744.7 mm) H x 15.62" (396.7 mm) W x 0.25" (6.4 mm) D	47605-28P
28" Premium Vented Hinged Door, 29.32" (744.7 mm) H x 15.62" (396.7 mm) W x 0.25" (6.4 mm) D	47605-28S
28" Enclosure, job packed, 3 per pack, 28.0" (711.2 mm) H x 14.38" (365.3 mm) W x 3.63" (92.2 mm) D	47605-28G
28" Flush-Mount Cover only, job packed, 3 per pack, 29.32" (744.7 mm) H x 15.62" (396.7 mm) W x 0.20" (5.1 mm) D	47605-28B
<b>[C]</b> 28" Pre-Fab Back Plate, 25" (635.0 mm) H x 13.5" (342.9 mm) W x 0.38" (9.65 mm) D	47605-2BP
<b>[G]</b> Extender Bracket, 2" depth extension package for 28" Structured Media Enclosures**	47612-28B
Structured Media Enclosure Lock & Key for 14", 21", 28", and 42" hinged doors	5L000-L0K

## 42" STRUCTURED MEDIA ENCLOSURES, COVERS & DOORS

42" Enclosure and Flush-Mount Cover, 43.32" (1,100.3 mm) H x 15.62" (396.7 mm) W x 3.83" (97.3 mm) D	47605-42W
<b>[D]</b> 42" Enclosure, 42.16" (1,070.8 mm) H x 14.38" (365.3 mm) W x 3.63" (92.2 mm) D	47605-42N
42" Multi-Dwelling Unit Configuration A, Enclosure and Flush-Mount Cover, 43.32" (1,100.3 mm) H x 15.62" (396.7 mm) W x 3.83" (97.3 mm) D*	47605-4MG
42" Multi-Dwelling Unit Configuration B, Enclosure only, 42.16" (1,070.8 mm) H x 14.38" (365.3 mm) W x 3.63" (92.2 mm) D*	47605-M42
42" Flush-Mount Cover, 43.32" (1,100.3 mm) H x 15.62" (396.7 mm) W x 0.20" (5.1 mm) D	47605-F42
42" Economy Hinged Door, 43.32" (1,100.3 mm) H x 15.62" (396.7 mm) W x 0.25" (6.4 mm) D	47605-42D
<b>[E]</b> 42" Premium Hinged Door, 43.32" (1,100.3 mm) H x 15.62" (396.7 mm) W x 0.25" (6.4 mm) D	47605-42P
42" Premium Vented Hinged Door, 43.32" (1,100.3 mm) H x 15.62" (396.7 mm) W x 0.25" (6.4 mm) D	47605-42S
<b>[F]</b> 42" Pre-Fab Back Plate, 40.0" (1,016.0 mm) H x 13.5" (342.9 mm) W x 0.38" (9.65 mm) D	47605-4BP
<b>[G]</b> Extender Bracket, 2" depth extension package for 42" Structured Media Enclosures**	47612-42B
Structured Media Enclosure Lock & Key for 14", 21", 28", and 42" hinged doors	5L000-L0K

### \*STRUCTURED MEDIA ENCLOSURE END CAPS

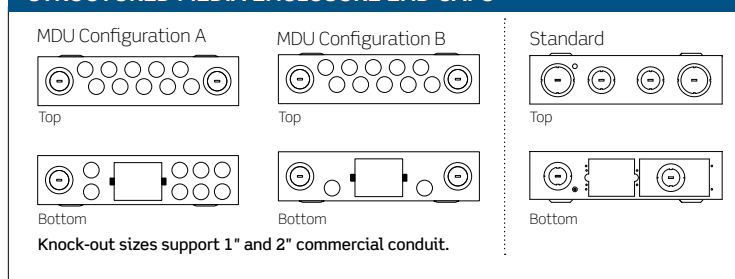

Leviton Extender Brackets provide an additional 2" of depth and enhanced ventilation for active gear within Leviton 28" and 48" Structured Media Enclosures. The brackets attach between the enclosure and the cover to form a 2" deep, vented frame. The increased depth also allows space for better cable management and for larger modules, such as audio amplifiers, to be mounted within the Structured Media Enclosure.

\*\*Extender Bracket (enclosure sold separately)



G



## CONCRETE-MOUNTABLE STRUCTURED MEDIA ENCLOSURES

Concrete-Mountable Structured Media Enclosures are specially designed for concrete pour and cinder-block construction methods. Built with stronger metal to withstand the weight associated with concrete pouring, and protected with two levels of corrosion resistance, these enclosures meet the differing demands of global building styles. They feature the Structured Media equipment-mounting hole pattern, and are compatible with all current covers, doors, and locks.

### Specifications & Features

- Designed to withstand added weight during concrete pouring
- Moisture-resistant powder coating binds with treated steel to provide multiple levels of corrosion protection and durability
- Knock-outs on the top and bottom support conduit up to 1.5" in diameter and facilitate cable routing and entry
- Power knock-out located on side panel for increased vertical cable routing capacity
- Optional duplex receptacle power box constructed using same steel as enclosures for protection of electrical wiring components
- Flush-mount covers and doors overlap 3/4" to hide uneven concrete/mortar finishing (sold separately)
- Durable powder coating withstands 1/8" dent test for cured flexibility (per ASTM D 522-93A standard) for minimized scratching, cracking, or peeling during shipping or installation

CONCRETE-MOUNTABLE STRUCTURED MEDIA ENCLOSURES	
DESCRIPTION	PART NO.
Concrete-Mountable Structured Media Enclosure, 21"	48605-21E
<b>[A]</b> Concrete-Mountable Structured Media Enclosure, 28"	48605-28E
Concrete-Mountable Structured Media Enclosure, 42"	48605-42E
Concrete-Mountable Structured Media Duplex Receptacle Power Box	48605-2GP



## RF TRANSPARENT ENCLOSURE

- Expands the reach of wireless signals by diminishing the effect of interference with the ABS polymer construction
- Reduces installation and repair downtimes, and improves system access with a 180° hinged cover, allowing for quick and easy access to network equipment
- Makes servicing and expansion easy with twelve 1" entry/exit ports and additional 3/4" knock-outs and conduit adapters
- Compatible with most Leviton Connected Home patch panels, voice, data, video, and audio quick-connect distribution modules
- Ensures safety with UL Compliant ABS flame-retardant polymer
- Vented for cooling

RF TRANSPARENT STRUCTURED MEDIA ENCLOSURE	
DESCRIPTION	PART NO.
<b>[B]</b> RF Transparent Structured Media Enclosure with Door, 30"	49605-30W

This integrated network system delivers a seamless experience that combines the wired performance of Gigabit Ethernet with the mobile-ready convenience of Wi-Fi® networking inside an innovative RF Transparent Structure Media enclosure.





### FTTH POINT OF ENTRY BOX

The Fiber-to-the Home (FTTH) Point of Entry Box provides a location to terminate fiber coming from a service provider to pigtails at the subscriber's premises. It's a convenient staging demarcation point with quick and easy access for activation as residents request FTTH service.

- Provides convenient staging prior to terminating incoming fiber from service provider
- Can mount inside the Structured Media® enclosure or as a stand-alone unit on a wall
- Includes magnet for easy installation and place adjustments
- Includes an SC/APC adapter with two dust caps and two splice sleeves
- Made of ABS plastic

### MULTI-BAY FTTH ENCLOSURES

Multi-Bay Enclosures provide excellent termination and mounting locations for both in-home structured wiring and fiber-to-the-home (FTTH) components. Structured wiring components typically mount in the upper section of the dual enclosure and optical network termination (ONT) mounts in the lower section. The dual enclosure can be surface-mounted or mounted between metal or wood wall studs using provided screws.

### Specifications & Features

- Allow separate lockable sections for FTTH integration
- In a separate bay, a full Leviton structured wiring system can be easily connected and optimized up to gigabit speeds to maximize incoming fiber optic connection
- Ideal for new installations or retrofits
- Use multiple covers or doors to provide access and security
- Flush-mount cover, economy, premium, and premium vented doors available

FIBER-TO-THE-HOME SOLUTION	
DESCRIPTION	PART NO.
<b>[A]</b> FTTH Point of Entry Box, 3.94" (100 mm) H x 3.15" (80 mm) W x .84" (21 mm) D Δ	FTH00-00W
MULTI-BAY ENCLOSURES	
14" + 14" Dual Multi-Bay Enclosure, 29.64" (752.8 mm) H x 14.30" (363.2 mm) W x 3.63" (92.2 mm) D	47FTH-440
<b>[B]</b> 28" + 14" Dual Multi-Bay Enclosure, 46.64" (1,184.6 mm) H x 14.30" (363.2 mm) W x 3.63" (92.2 mm) D Δ	47FTH-840
28" + 14" + 14" Triple Multi-Bay Enclosure, 59.22" (1,504.1 mm) H x 14.30" (363.2 mm) W x 3.63" (92.2 mm) D	47FTH-844
42" + 14" Dual Multi-Bay Enclosure, 57.64" (1,464.1 mm) H x 14.30" (363.2 mm) W x 3.63" (92.2 mm) D	47FTH-420
14" + 14" + 14" Triple Multi-Bay Enclosure, 45.22" (1,148 mm) H x 14.30" (363.2 mm) W x 3.63" (92.2 mm) D Δ	47FTH-240
<b>[C]</b> 28" + 28" Dual Multi-Bay Enclosure, 57.64" (1,464.1 mm) H x 14.30" (363.2 mm) W x 3.63" (92.2 mm) D	47FTH-880

Note: See pages F7-F10 for covers and doors. Δ = Minimum order quantity and lead times may apply.



## 100 MBPS ROUTER

- 10/100 Mbps data transfer rate
- Enables multiple users to share a single, secure high-speed Internet connection
- Includes four ports for in-home LAN connections
- LEDs indicate power, status, LINK/Activity, 100 Mbps, and WAN
- Built-in NAT firewall provides secure communication for network users
- Customizes Web access and filters unwanted sites with URL blocking feature
- UPnP (universal plug-n-play) allows automatic discovery and configuration of the Gateway; UPnP supported by Windows XP® or later

## GIGABIT ROUTER

- Compliant with IEEE 802.11a/b/g/n dual band (2.4G & 5G simultaneously) wireless technology capable up to 300+300 Mbps data rate
- Advanced security: 64/128-bit WEP, WPA/WPA2 and WPA-PSK/WPA2-PSK (TKIP/AES encryption)
- Supports Wi-Fi® Protected setup (WPS), NAT firewall, IP/port/URL-based access control, and MAC address filtering
- Includes Gigabit RJ-45 ports (10/100/1000 Mbps) of 1 WAN and 4 LAN ports
- Supports dual-SSID to access different networks through a single AP
- Supports NTP, Virtual Server, UPnP, and DMZ for various networking applications
- Includes USB port for sharing printers and USB mass storages
- Includes bracket for mounting in Structured Media® enclosures



## GIGABIT ETHERNET SWITCHES

- 10/100/1000 Mbps data transfer rate
- Power button arrows for easy power down
- LEDs indicate power; LINK/Activity; and 10, 100, or 1000 Mbps
- Plug-n-play installation
- Auto detect uplink to easily cascade additional hubs, switches, and routers from any port
- Features high-performance, store-and-forward switching architecture with CRC

## 100 MBPS ETHERNET SWITCHES

- 10/100 Mbps data transfer rate
- Network additional PCs, printers, and other peripherals beyond router capacity
- Connects to many home office Ethernet devices
- Available in 5- and 8-port versions

DATA NETWORKING ROUTERS & SWITCHES		
DESCRIPTION	PART NO.	
<b>[A]</b> 100 Mbps 4-Port Internet Router, 2.52" (64 mm) H x 6.50" (165.1 mm) W x 3.54" (89.9 mm) D	47611-GT4	
<b>[B]</b> Gigabit 4-Port Router and 300 Mbps Dual-Band Wi-Fi, 6.76" (171.61 mm) H x 4.38" (111.16 mm) W x 1.01" (25.47 mm) D	47611-WG4	
<b>[C]</b> 100 Mbps 5-Port Ethernet Switch, 2.52" (64 mm) H x 6.50" (165.1 mm) W x 3.54" (89.9 mm) D	47611-5PT	
<b>[D]</b> 100 Mbps 8-Port Ethernet Switch, 2.52" (64 mm) H x 6.50" (165.1 mm) W x 3.54" (89.9 mm) D	47611-8PT	
<b>[E]</b> Gigabit 5-Port Ethernet Switch, 2.52" (64 mm) H x 6.50" (165.1 mm) W x 3.54" (89.9 mm) D	47611-5GB	
Gigabit 8-Port Ethernet Switch, 2.52" (64 mm) H x 6.50" (165.1 mm) W x 3.54" (89.9 mm) D	47611-8GB	

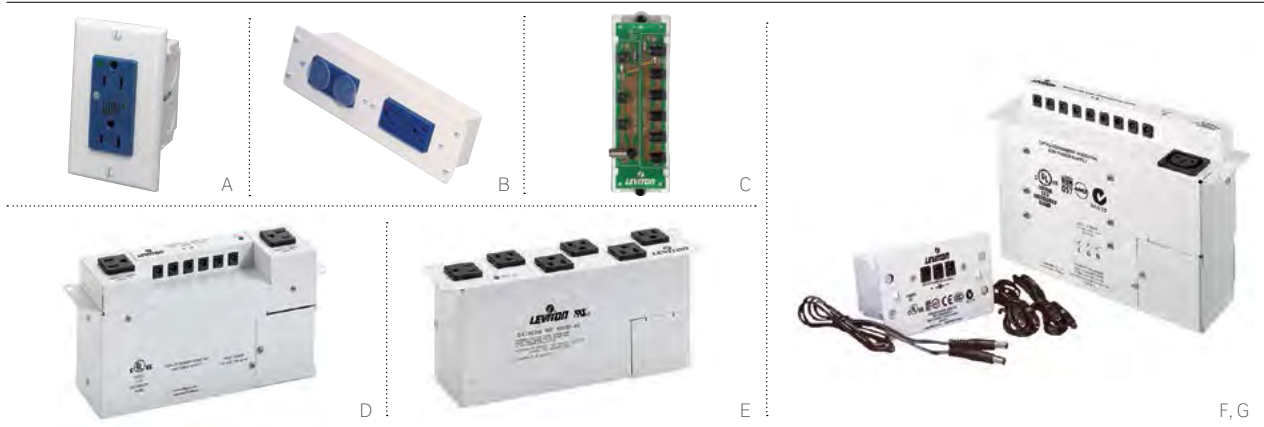

## SURGE-PROTECTION, STANDARD AC POWER MODULES & J-BOX KITS

- Fit in standard 14", 21", 28", and 42" Structured Media® Enclosures
- Surge-protected versions provide enhanced protection and EMI/RFI filtering per UL 1449 standards

## DC BUS MODULE

- Eliminates need for more than two bulky AC/DC power adapters
- Contains six 12 VDC power outputs at up to 1500 mA total
- Contains three 24 VDC power outputs at up to 1000 mA total including one F-connector
- Output power cables included for all except 24 VDC F-connector connection

## VERSATILE DC POWER SUPPLIES

- 120 VAC - 60 Hz input
- Provides 12 VDC outputs with surge protection at 3.34A total
- Includes NEMA 5-15 AC receptacles at 15A total
- Eliminates the need for multiple bulky AC/DC power adapters

## AC SURGE MODULES

- Includes six surge-protected NEMA 5-15P receptacles
- Allows six AC/DC power adapters to fit easily into Structured Media Enclosures
- Powers routers, switches, modems, volume controls, camera hubs, and other Structured Media mounted devices

## UNIVERSAL MINI DC POWER SUPPLIES

- 90 - 264 VAC - 50/60 Hz input
- Provides three 12 VDC outputs with surge protection at 833 mA total
- Eliminates the need for multiple bulky AC/DC power adapters

## UNIVERSAL DC POWER SUPPLIES

- 100 - 240 VAC - 50/60 Hz input
- Provides nine 12 VDC outputs with surge protection at 3.34A total
- Includes one IEC AC power receptacle
- Eliminates the need for multiple bulky AC/DC power adapters

POWER SUPPLIES	
DESCRIPTION	PART NO.
<b>[A]</b> Surge J-Box Kit, one duplex receptacle, wallplate	47605-ACS
Non-Surge J-Box Kit, one duplex receptacle, wallplate	47605-ACN
<b>[B]</b> Surge AC Power Module, two duplex receptacles	47605-ODP
Non-Surge AC Power Module, two duplex receptacles	47605-NDP
<b>[C]</b> DC Bus Module, 12 VDC and 24 VDC	48212-124
<b>[D]</b> Versatile Power Supply, six 12 VDC connectors and two NEMA 15A receptacles	47605-PSC
<b>[E]</b> AC Surge Module, six receptacles	48212-06S
<b>[F]</b> Universal Mini DC Power Supply, three 12 VDC connectors	47605-PSB
<b>[G]</b> Universal DC Power Supply, nine 12 VDC connectors and one IEC AC receptacle	47605-PSA
IEC TO NEMA 15A Adapter Power Cord, 12" (accessory for 47605-PSA)	48212-IEC

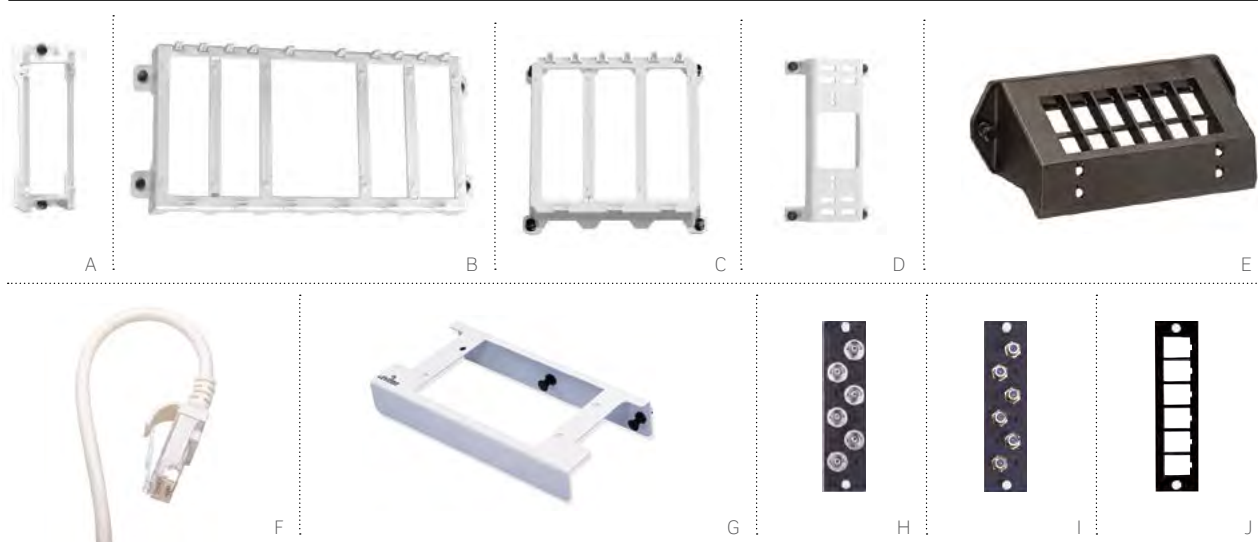

MOUNTING BRACKETS	
DESCRIPTION	PART NO.
[A] Single Plastic Bracket, for single expansion board, white	47612-SBK
[B] Standard (12" width) Expansion Plastic Bracket, for up to five expansion boards, white	47612-EBK
Shelf Plastic Bracket, for up to three expansion boards and CATV splitter, white (compact width)	47612-VSB
[C] Compact (6" width) Expansion Plastic Bracket, for up to three expansion boards, white	47612-HBK
[D] Data Plastic Bracket, for mounting routers and switches	47612-DBK
[E] 12-Port QuickPort Mounting Bracket	47600-QPB

## MOUNTING BRACKETS

- Made of sturdy white ABS plastic
- Include push-lock pins
- Snap-in installation in any Leviton 14", 21", 28", or 42" Structured Media® Enclosure
- Allow for cable management via routing under bracket
- 12-port bracket made of black polycarbonate
- 12-port bracket accepts all QuickPort® connectors

HOME 5E® PATCH CORDS	
DESCRIPTION	PART NO.
[F] High-Flex Home 5e Patch Cord	5HHOM-xx*
8-Conductor Flat Telephone Patch Cord, 8" long	42400-8FG

xx = Length: 6" (6), 1' (01), 2' (02), 3' (03), or 4' (04)  
 \* = Colors: Choose from either of the colors below.

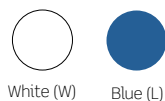

## HOME 5E PATCH CORDS

- Low-profile High-Flex Patch Cords allow tighter radius connections
- Available in five lengths and two colors

MULTIMEDIA ADAPTER BRACKET & MOUNTING PLATES	
DESCRIPTION	PART NO.
[G] Multimedia Adapter Bracket	47612-MMA
[H] BNC Mounting Plate, 6-pack, loaded	5F100-BNC
[I] F-Connector Mounting Plate, 6-pack, loaded	5F100-6VF
[J] QuickPort Mounting Plate, 6-pack, unloaded	5F100-6QP

## MULTIMEDIA ADAPTER BRACKET & MOUNTING PLATES

- Bracket is constructed of white powder-coated steel
- Plates are constructed of black powder-coated steel
- Bracket includes push-lock pins for mounting in Structured Media Enclosures

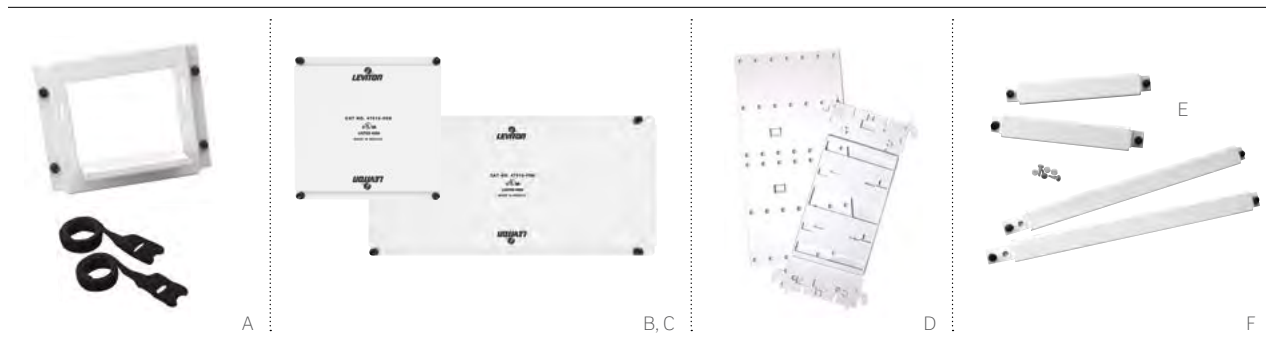

## UNIVERSAL SECURITY & SHELF BRACKETS

- **Universal Shelf Bracket** allows security batteries and other active products to be mounted inside any Structured Media® Enclosure
- **Shelf Bracket** includes four 8" long VELCRO® Brand strips, ensuring vertical and horizontal stability
- **Universal Security Board Mounting Plate** includes four adhesive clips for mounting within any Leviton Structured Media Enclosure
- **Combo Bracket** allows Leviton products to be installed in most non-Leviton structured wiring enclosures
- **Universal Mounting Brackets** allow an unlimited number of upgrades (limited only by enclosure size) to be added to an existing security system terminated within any Leviton Structured Media Enclosure
- **Universal Brackets** are sold in pairs with self-tapping screws and spacers to easily connect the largest number of security alarm manufacturers' panels

## UNIVERSAL SECURITY & SHELF BRACKETS

DESCRIPTION	PART NO.
<b>[A]</b> Universal Shelf Bracket	47612-UBK
<b>[B]</b> Compact (6" width) Universal Security Board Mounting Plate	47612-HSB
<b>[C]</b> Standard (12" width) Universal Security Board Mounting Plate	47612-FSB
<b>[D]</b> Combo Bracket	47612-CBK
<b>[E]</b> Compact (6" width) Universal Mounting Bracket	47612-6SB
<b>[F]</b> Standard (12" width) Universal Mounting Bracket	47612-1SB

## RESIDENTIAL TOOLS

DESCRIPTION	PART NO.
<b>[G]</b> Residential Tool Kit includes Punchdown Tool w/ 110 blade, EZ-RJ45® Crimp Tool, two Level Coaxial Cable Strippers, UTP Stripping Tool, Coax and Round Wire Cable Cutter, EZ-RJ45 Connectors, and screwdriver	40812-RTK
Wire Punchdown / Termination Tool, blades sold separately	49553-814
110 IDC Blade	49553-110
66-Clip Blade	49553-066
BIX® Blade	49553-BIX
Krone® Blade	49553-KRN
Awl (woodscrew starter punch)	49553-AWL
Master Compression Tool	40989-CPT
UTP Stripping Tool	49660-00P
Coaxial Stripping Tool	C5914-000
EZ-RJ45 Crimp Tool	40989-ACT



## RESIDENTIAL ACCESSORIES

DESCRIPTION	PART NO.
EZ-RJ45 Connector, 50/pack	47613-EZC
EZ-RJ45 Connector Display Pack, 10/pack	47613-EZR
Push-Lock Pins for Structured Media Enclosures, 20/pack	47615-NYL
Reclosable Tie-Wrap, 5" Length, 25/pack	43105-005



## TWIST & MOUNT PATCH PANELS

- Low-profile, high-density, component-rated patching for both voice and gigabit ethernet connections
- Feature simple twist and mount installation
- Universal T568A and T568B wiring labels ensure compatibility in residential and commercial installations
- Available in 12- and 24-port versions

## TELEPHONE INPUT DISTRIBUTION PANELS (TIDP)

- Supports four-line telephone distribution
- Offers choice of inputs and outputs: one 4-pair 110-style IDC input, four industry-standard RJ-11 jack inputs, or 12 modular industry-standard RJ-45 jack outputs
- Security jack for interface with security systems
- Test and auxiliary disconnect outlet (ADO) ports for isolation and testing of telephone line connections

TWIST & MOUNT PANELS & TELEPHONE DISTRIBUTION PANELS	
DESCRIPTION	PART NO.
Twist & Mount Patch Panel - 12 ports each of CAT 6 and CAT 5e (24 ports total)	476TM-654
<b>[A]</b> Twist & Mount Patch Panel - 24 ports of CAT 6	476TM-624
Twist & Mount Patch Panel - 24 ports of CAT 5e	476TM-524
Twist & Mount Patch Panel - 6 ports each of CAT 6 and CAT 5e (12 ports total)	476TM-652
Twist & Mount Patch Panel - 12 ports of CAT 6	476TM-612
<b>[B]</b> Twist & Mount Patch Panel - 12 ports of CAT 5e	476TM-512
<b>[C]</b> Telephone Input Distribution Panel (TIDP)	476TL-T12

## PRE-CONFIGURED COMPACT STRUCTURED MEDIA PANELS

- Compact series (6" width) pre-configured panels are an ideal solution for basic telephone, data, security interface, and TV distribution in MDUs where space and budget are of primary concern
- Space-saving profile provides four to nine bridged telephone connections, up to four CAT 5e data connections, and up to eight video connections

PRE-CONFIGURED COMPACT STRUCTURED MEDIA PANELS - COMPACT WIDTH (6")	
DESCRIPTION	PART NO.
1x9 Bridged Telephone and 4-way 1 GHz TV Splitter	47603-1G4
<b>[D]</b> 1x9 Bridged Telephone and 6-way 1 GHz TV Splitter	47603-1G6
1x9 Bridged Telephone and 8-way 1 GHz TV Splitter	47603-1G8
<b>[E]</b> 1x4 Bridged Telephone, 4 Data, and 6-way 1 GHz TV Splitter	47603-DP6
1x7 Bridged Telephone, Security Interface, and 6-way 1 GHz TV Splitter	47603-TSV

### SPOTLIGHT

### Compact vs. Standard Structured Media Panels

**Compact Structured Media Panels'** space-saving profile is half the size of standard panels, and is ideal when space and budget is a primary concern.

**Standard Structured Media Panels** combine multiple modules into a simple distribution point, and provide greater versatility when it comes time for customization or expanding.



Compact



Standard



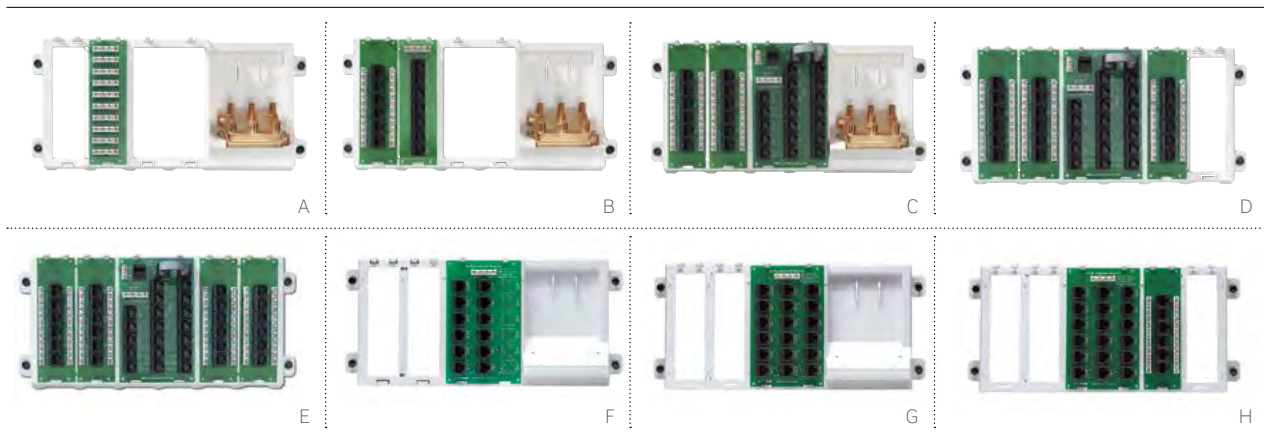

## PRE-CONFIGURED STANDARD STRUCTURED MEDIA PANELS

- Standard series (12" width) pre-configured panels combine voice, data, and TV modules into a single, simple distribution point
- Several pre-configured options are available with room for customization with additional expansion boards

PRE-CONFIGURED STANDARD STRUCTURED MEDIA PANELS		
DESCRIPTION	FEATURES	PART NO.
<b>[A]</b> Basic Telephone & Video Panel	- One 1x9 Bridged Telephone Board - One 6-way 2 GHz TV Splitter	47606-BTV
<b>[B]</b> Basic Home Networking Plus Panel	- One Telephone Patching Board - One CAT 5e Voice & Data Board - Six 4-line telephone connections - One 6-way 2 GHz TV Splitter	47606-BNP
Advanced Home Telephone & Video Panel	- One Telephone Line Distribution Board - 19 multi-line telephone connections (in various combinations of two or four lines) - One CAT 5e Voice & Data Board - One 6-way 2 GHz TV Splitter	47606-AHT
<b>[C]</b> Advanced Home Office Panel	- One Telephone Line Distribution Board - 19 multi-line telephone connections (in various combinations of two or four lines) - Two CAT 5e Voice & Data Boards - One 6-way 2 GHz TV Splitter	47606-ASO
12-Port Structured Media Panel	- One Telephone Line Distribution Board - 19 multi-line telephone connections (in various combinations of two or four lines) - Two CAT 5e Voice & Data Boards	47603-12P
<b>[D]</b> 18-Port Structured Media Panel	- One Telephone Line Distribution Board - 19 multi-line telephone connections (in various combinations of two or four lines) - Three CAT 5e Voice & Data Boards	47603-18P
<b>[E]</b> 24-Port Structured Media Panel	- One Telephone Line Distribution Board - 19 multi-line telephone connections (in various combinations of two or four lines) - Four CAT 5e Voice & Data Boards	47603-24P
<b>[F]</b> 4x12 Telephone Distribution Panel	- One 4x12 Telephone Distribution Board	47603-12M
4x12 Telephone Distribution Panel w/ Splitter	- One 4x12 Telephone Distribution Board - One 8-way 2 GHz TV Splitter	47603-412
<b>[G]</b> 4x18 Telephone Distribution Panel	- One 4x18 Telephone Distribution Board	47603-18M
<b>[H]</b> 4x18 Telephone Distribution Panel w/ CAT 5e Board	- One 4x18 Telephone Distribution Board - One CAT 5e Voice & Data Board	47603-8C1

# MDU | Modules & Expansion Boards

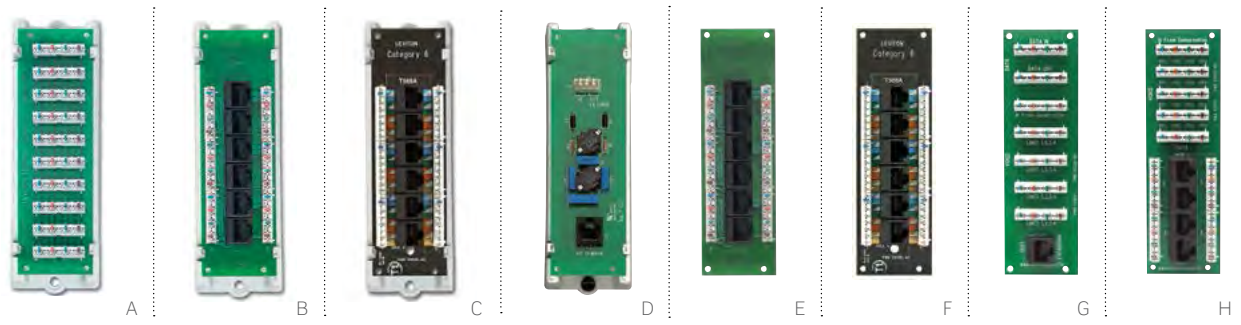

MODULES		
DESCRIPTION		PART NO.
[A]	1x9 Bridged Telephone Module	47689-00B
[B]	CAT 5e Voice & Data Module	47605-C5B
[C]	CAT 6 Voice & Data Module	47611-C6B
[D]	DSL Filter Module	47616-DSF
	Telephone Security Module	47609-TSV

EXPANSION BOARDS				
DESCRIPTION	APPLICATION	FEATURES	PART NO.	
[E]	CAT 5e Voice and Data Board	Data, Telephone, Fax, Modem	<ul style="list-style-type: none"> <li>- Patch phone or data connections to six locations</li> <li>- Combine with a TLDM, key system, or network switches</li> <li>- 4-pair 110-type IDC punchdowns</li> <li>- Six CAT 5e RJ-45 ports</li> <li>- Printed circuit board</li> </ul>	47603-0C5
[F]	CAT 6 Voice and Data Board	Data, Telephone, Fax, Modem	<ul style="list-style-type: none"> <li>- TIA-568-C channel-rated for gigabit Ethernet</li> <li>- Combine with gigabit Internet router or Ethernet switch</li> <li>- 4-pair 110-type IDC punchdowns and six CAT 6 connectors</li> </ul>	47611-0C6
[G]	VDSL Board w/ 1x5 Bridged Phone w/ Data Passthrough IDCs	Data, Telephone, Modem	<ul style="list-style-type: none"> <li>- Bridge up to four telephone lines to five locations</li> <li>- Connect up to five separate telephones per line</li> <li>- IDC connectors for CAT 5 or CAT 5e wire</li> <li>- Termination point and pass-through for a data connection via IDCs up to 150 MHz</li> </ul>	47609-D5P
[H]	Combo Phone & Data Board w/ 1x4 Bridged Phone and 4-Port CAT 5e	Data, Telephone	<ul style="list-style-type: none"> <li>- Provides data and phone connections on a single board</li> <li>- 1x4 phone portion provides four telephone lines to up to four locations via IDC punchdowns</li> <li>- Four ports of CAT 5e 150 MHz data connections via modular RJ-45 connectors and 4-pair 110-type IDC punchdowns</li> </ul>	47609-4DP

modules & expansion boards

MDU

## SPOTLIGHT Panels, Modules, Boards: What's the difference?

**Pre-configured Structured Media® Panels** include multiple expansion boards combining voice, data, and TV boards into a single distribution point.

**Modules** include an expansion board on a single ABS mounting bracket.

**Expansion Boards** mount in Structured Media Panels or Mounting Brackets (see page F15).



Pre-configured Structured Media Panels

Module

Expansion Board

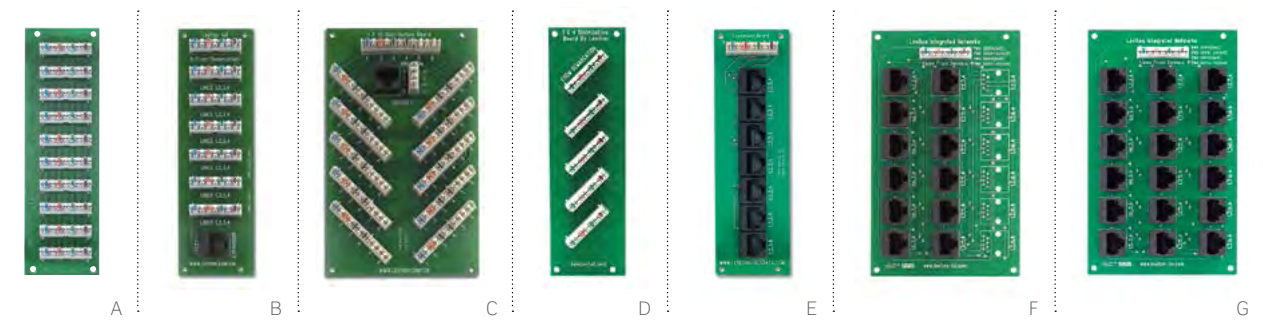

EXPANSION BOARDS (CONTINUED)			
DESCRIPTION	APPLICATION	FEATURES	PART NO.
<b>[A]</b> 1x9 Bridged Telephone Board	Telephone, Fax, Modem	<ul style="list-style-type: none"> <li>- Bridge up to four telephone lines to nine locations</li> <li>- Connect up to nine separate telephones per line</li> <li>- Printed circuit board</li> <li>- 4-pair 110-type IDC punchdowns</li> </ul>	47603-110
<b>[B]</b> 1x6 Bridged Telephone Board	Telephone, Fax, Modem	<ul style="list-style-type: none"> <li>- Bridge up to four telephone lines to six locations</li> <li>- Connect up to six separate telephones per line</li> <li>- Printed circuit board</li> <li>- IDC connectors for CAT 5 or CAT 5e wire</li> <li>- RJ-45 expansion port</li> </ul>	47609-0F6
<b>[C]</b> 1x10 Bridged Telephone Board	Telephone, Fax, Modem	<ul style="list-style-type: none"> <li>- Bridge up to six telephone lines to 10 locations</li> <li>- Connect up to 10 separate telephones per line</li> <li>- Printed circuit board</li> <li>- IDC connectors for CAT 5 or CAT 5e wire</li> <li>- Security port</li> <li>- Punchdown security interface to accommodate alarm systems</li> </ul>	47609-S10
<b>[D]</b> 1x4 Bridged Telephone Board	Telephone, Fax, Modem	<ul style="list-style-type: none"> <li>- Bridge up to four lines to four locations via IDC punchdowns</li> </ul>	47609-004
<b>[E]</b> Telephone Patching Board/ Expanded 4-line Telephone Distribution	Telephone, Fax, Modem	<ul style="list-style-type: none"> <li>- Bridge up to four telephone lines to seven locations</li> <li>- Printed circuit board module</li> <li>- One incoming 4-pair 110-type IDC punchdown</li> <li>- Seven outgoing RJ-45 connector connections</li> <li>- Combine with a CAT 5e board to route telephone to remote locations</li> </ul>	47609-EMP
DSL Filter Board	Telephone, Modem	<ul style="list-style-type: none"> <li>- Filters DSL signal from phone line before distribution throughout home or office</li> <li>- Eliminates need for individual filters at wallplate</li> <li>- Use with any phone distribution module</li> <li>- Printed circuit board module w/ RJ-45 connector and 110-type punchdown</li> </ul>	47616-DSF
Telephone Line Distribution Board	Telephone, Fax, Modem	<ul style="list-style-type: none"> <li>- 19 multi-line telephone connections in combinations of two or four lines</li> <li>- Bridge "line 1" service to 12 locations and four-line service to eight locations</li> <li>- Connect to CAT 5e Voice &amp; Data Board(s) or additional panels for more connections and easier moves/adds/changes</li> <li>- Independent RJ-45 connector and punchdown security interface to accommodate alarm systems</li> </ul>	47603-TDM
<b>[F]</b> 4x12 Telephone Distribution Board	Telephone, Fax	<ul style="list-style-type: none"> <li>- Bridge up to four telephone lines to 12 locations</li> </ul>	47603-12B
<b>[G]</b> 4x18 Telephone Distribution Board	Telephone, Fax	<ul style="list-style-type: none"> <li>- Bridge up to four telephone lines to 18 locations</li> </ul>	47603-18B

MDU expansion boards



## PREMIUM AMPLIFIED CATV/HDTV MODULE

- Split and/or amplify signal to 1, 8, or 16 TVs throughout the home
- Bi-directional circuitry supports advanced interactive applications, as well as standard TV and video inputs
- Forward path internal amplifier provides equal input and output level on all ports; reverse path is not affected
- Unity gain eliminates the need to manually adjust attenuation
- HDTV and digital cable ready, SCTE- and DOCSIS-compliant

## 3X1 PASSIVE COMBINER MODULE

- Digital CATV compatible
- Provides bi-directional signal path to support cable modem or digital cable communications
- F-ports provide up to 15 psi weather sealing

## PASSIVE CATV/HDTV SPLITTERS

- Split signal to 4, 6, or 8 TVs throughout the home
- Provide digital cable, cable TV, and other TV services via coaxial cable
- Lightweight, strong die-cast housing
- HDTV and digital cable ready SCTE-compliant
- Available with and without Structured Media® Enclosure mounting bracket

PREMIUM MODULES			
DESCRIPTION	1 GHZ		
[A] 1x1 Premium Video Module	47693-01P		
[B] 1x8 Premium Video Module	47693-08P		
[C] 1x16 Premium Video Module	47693-16P		
[D] 3x1 Passive Combiner	47693-31P		
PASSIVE SPLITTERS W/ MOUNTING BRACKET			
DESCRIPTION	1 GHZ	2 GHZ	
[E] 1x4 Passive Video Splitter w/ bracket for 14", 21", 28", and 42" Structured Media Enclosures	47690-04C	47690-4C2	
[F] 1x6 Passive Video Splitter w/ bracket for 14", 21", 28", and 42" Structured Media Enclosures	47690-06C	47690-6C2	
[G] 1x8 Passive Video Splitter w/ bracket for 14", 21", 28", and 42" Structured Media Enclosures	47690-08C	47690-8C2	
PASSIVE SPLITTERS			
DESCRIPTION	1 GHZ	2 GHZ	
[H] 1x4 Passive Video Splitter	47690-004	47690-0G4	
[I] 1x6 Passive Video Splitter	47690-006	47690-0G6	
[J] 1x8 Passive Video Splitter	47690-008	47690-0G8	

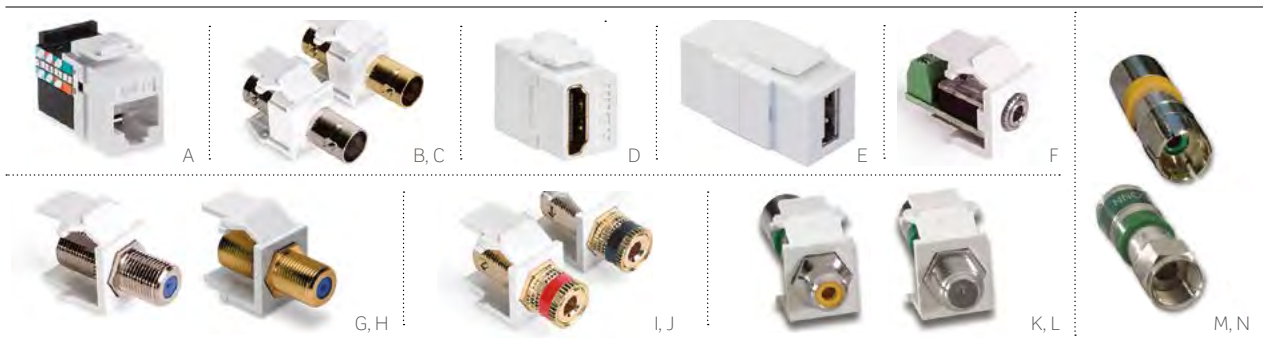

**DATA & A/V CONNECTORS**

DESCRIPTION	APPLICATIONS	PART NO.
QuickPort® CAT 5 Connector	Voice and low-speed data	41108-R#5
QuickPort CAT 3 Connector	Voice and low-speed data	41108-R#3
<b>[A]</b> QuickPort GigaMax® CAT 5e Connector	High-speed data	5G108-R#5
QuickPort Voice-Grade 6-Conductor Connector	Voice	41106-R#6
QuickPort Voice-Grade 8-Conductor Connector	Voice	41108-R#8
<b>[B]</b> QuickPort BNC Bulkhead Module, standard	CCTV and video	41084-B*F
<b>[C]</b> QuickPort BNC Bulkhead Module, gold plated	CCTV and video	40832-0B*
<b>[D]</b> QuickPort HDMI Passthrough	TV, DVD, satellite, and home theater	40834-00#
QuickPort S-Video Feedthrough	Enhanced video streams	40734-CV~
<b>[E]</b> QuickPort USB A-A Connector, feedthrough	Computers and peripherals	40835-00~
<b>[F]</b> QuickPort 3.5 mm Stereo, screw terminal	Computer audio	40839-S~S
<b>[G]</b> QuickPort F-Connector, standard, 3.0 GHz	TV, DVD, satellite, and home theater	41084-F*F
<b>[H]</b> QuickPort F-Connector, gold plated, 3.0 GHz	TV, DVD, satellite, and home theater	40831-0B*
QuickPort RCA to 110	Advanced audio and video	40735-Rx†
QuickPort RCA w/ black stripe	Advanced audio and video	40830-B*E
QuickPort RCA w/ red stripe	Advanced audio and video	40830-B*R
QuickPort RCA w/ yellow stripe^	Advanced audio and video	40830-B*Y
QuickPort RCA w/ green stripe	Advanced audio and video	40830-B~V
QuickPort RCA w/ blue stripe	Advanced audio and video	40830-B~L
QuickPort Banana Jack Adapter, gold plated w/ black stripe	Advanced audio	40837-B*E
QuickPort Banana Jack Adapter, gold plated w/ red stripe	Advanced audio	40837-B*R
<b>[I]</b> QuickPort Binding Post Adapter, gold plated w/ black stripe	Advanced audio	40833-B*E
<b>[J]</b> QuickPort Binding Post Adapter, gold plated w/ red stripe	Advanced audio	40833-B*R
QuickPort Snap-in Blank Module	Secures unused ports	41084-B*B
<b>[K]</b> QuickPort Compression RCA Connector	Advanced audio and video	40782-R*W
<b>[L]</b> QuickPort Compression F-Connector (white only)	TV, DVD, satellite, and home theater	40782-CPF
<b>[M]</b> RCA Compression Connector (colored rings included)	CCTV and video	40985-CRU
<b>[N]</b> Compression F-Connector	CCTV and video	40985-CPF

^ = Minimum order quantity and lead times may apply.  
 ~ = Color: White (W), Ivory (I)  
 x = Inner Barrel Color: Orange (O), Red (R), White (W), Yellow (Y)  
 † = Color: White (W), Light Almond (T), Ivory (I), Grey (G), Black (E)  
 • = Inner Barrel Color: Black (E), Yellow (Y), Red (R), Blue (L), Green (V)  
 ‡ = Color: Choose from any of the 13 colors shown at right.  
 \* = Color: White (W), Light Almond (T), Ivory (I), Grey (G), Black (E), Brown (B)  
 ° = Color: White (W), Light Almond (T), Ivory (I)  
 # = Color: White (W), Light Almond (T), Ivory (I), Black (E)



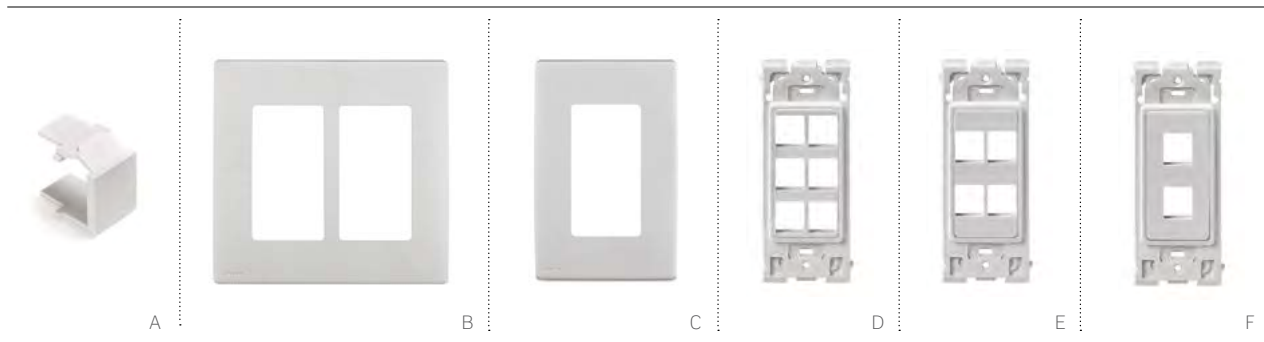

Renu is Leviton’s smart electrical and data connectivity screwless wallplate system. These QuickPort® compatible wallplates snap on and off quickly and easily with no tools, simplifying installation and ongoing maintenance. Choose from wallplates and inserts in White On White, Navajo Sand, and Onyx Black.

### RENU WALLPLATES AND INSERTS

- Screwless wallplates easily snap on to any Renu insert or device
- Inserts accept all QuickPort connectors
- Slightly larger size covers wall imperfections
- Tongue and groove design simplifies alignment in multi-gang installations
- Adapter ring allows use of Decora® device with Renu wallplates
- Available in three standard colors to coordinate with the commercial-grade QuickPort line (white, light almond, black)
- Additional wallplate colors for switches, dimmers, and outlets available; visit [leviton.com/renu](http://leviton.com/renu)
- cULus Listed

RENU WALLPLATES & INSERTS				
DESCRIPTION	WHITE ON WHITE	NAVAJO SAND	ONYX BLACK	
<b>[A]</b> Snap-In Blank Module	RE640-BWW	RE640-BNS	RE640-BOB	
Four-Gang Wallplate	REWP4-0WW	REWP4-ONS	REWP4-OOB	
Three-Gang Wallplate	REWP3-0WW	REWP3-ONS	REWP3-OOB	
<b>[B]</b> Dual-Gang Wallplate	REWP2-0WW	REWP2-ONS	REWP2-OOB	
<b>[C]</b> Single-Gang Wallplate	REWP1-0WW	REWP1-ONS	REWP1-OOB	
<b>[D]</b> 6-Port Insert	RE640-WW6	RE640-NS6	RE640-OB6	
<b>[E]</b> 4-Port Insert	RE640-WW4	RE640-NS4	RE640-OB4	
3-Port Insert	RE640-WW3	RE640-NS3	RE640-OB3	
<b>[F]</b> 2-Port Insert	RE640-WW2	RE640-NS2	RE640-OB2	
1-Port Insert	RE640-WW1	RE640-NS1	RE640-OB1	



Renu Wallplate and 2-Port Insert with QuickPort Connectors

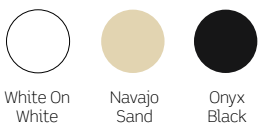

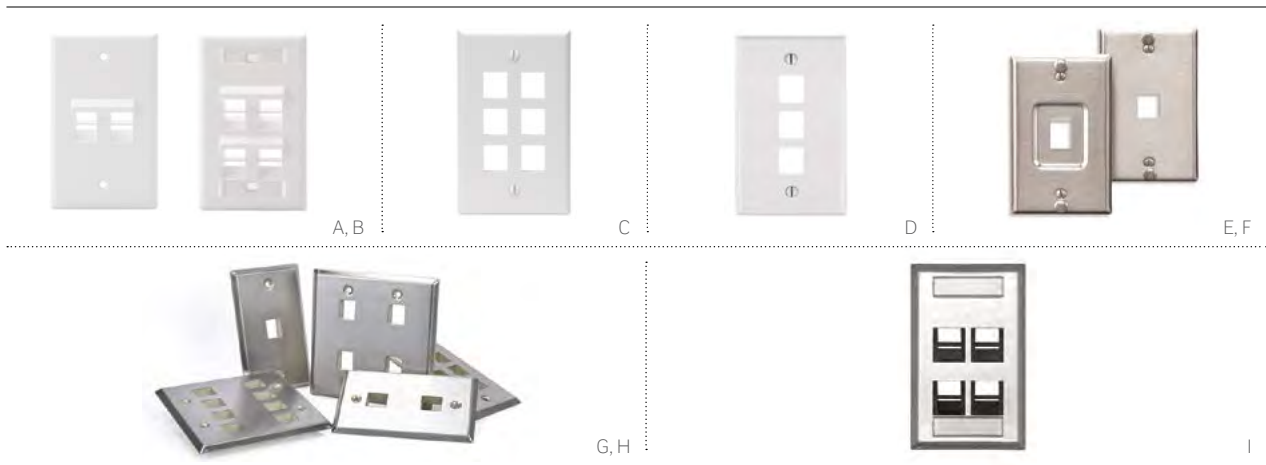

**QUICKPORT FLUSH-MOUNT & ANGLED WALLPLATES**

- Angled ports relieve stress on equipment cords
- Manufactured from ABS plastic for superior durability

**QUICKPORT STAINLESS-STEEL WALLPLATES**

- Manufactured from 304 stainless steel in a brushed finish to provide corrosion resistance in a non-magnetic material
- Angled wallplate ports facilitate proper front and rear cable bend radius

QUICKPORT ANGLED WALLPLATES					
DESCRIPTION	WHITE	LIGHT ALMOND	IVORY		
4-Port Wallplate	41081-4WP	41081-4TP	41081-4IP		
<b>[A]</b> 2-Port Wallplate	41081-2WP	41081-2TP	41081-2IP		
<b>[B]</b> 4-Port Wallplate w/ ID window	42081-4WS	42081-4TS	42081-4IS		
2-Port Wallplate w/ ID window	42081-2WS	42081-2TS	42081-2IS		
QUICKPORT FLUSH-MOUNT WALLPLATES					
<b>[C]</b> 6-Port Flush Mount, polybag, standard carton	41080-6WP	41080-6TP	41080-6IP		
4-Port Flush Mount, polybag, standard carton	41080-4WP	41080-4TP	41080-4IP		
<b>[D]</b> 3-Port Flush Mount, polybag, standard carton	41080-3WP	41080-3TP	41080-3IP		
2-Port Flush Mount, polybag, standard carton	41080-2WP	41080-2TP	41080-2IP		
1-Port Flush Mount, polybag, standard carton	41080-1WP	41080-1TP	41080-1IP		
QUICKPORT STAINLESS-STEEL WALLPHONE PLATE		RECESSED	FLUSH		
<b>[E,F]</b> 1-Port Wallplate		4108W-1SP	4108W-0SP		
QUICKPORT SINGLE-GANG STAINLESS-STEEL WALLPLATES					
DESCRIPTION	1-PORT	2-PORT	3-PORT	4-PORT	6-PORT
<b>[G]</b> Single-Gang Wallplate	43080-1S1	43080-1S2	43080-1S3	43080-1S4	43080-1S6
QUICKPORT DUAL-GANG STAINLESS-STEEL WALLPLATES					
DESCRIPTION	2-PORT	4-PORT	6-PORT	8-PORT	12-PORT
<b>[H]</b> Dual-Gang Wallplate	43080-2S2	43080-2S4	43080-2S6	43080-2S8	43080-S12
QUICKPORT ANGLED STAINLESS-STEEL WALLPLATES WITH ID WINDOWS					
DESCRIPTION					PART NO.
<b>[I]</b> 4-Port Angled Wallplate, single-gang					43081-1L4

Midsized plates in plastic and high-impact nylon also available. See page A50 or call inside sales at 800-722-2082.

quickport wallplates

MDU

# MDU | Decora® Wallplates & Multimedia Inserts

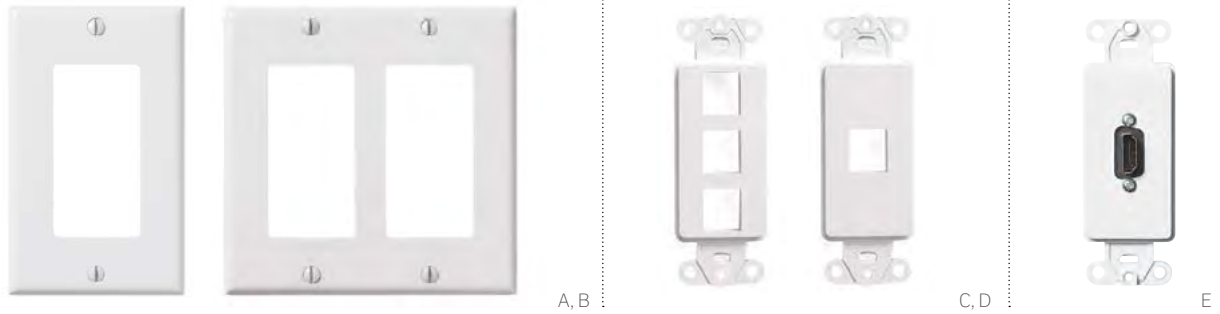

DECORA SINGLE- & DUAL-GANG WALLPLATES			
DESCRIPTION	SINGLE GANG	DUAL GANG	
<b>[A, B]</b> Decora, standard size, urea	80401-00*	80409-00*	
Decora, standard size, nylon	80401-0N*	80409-0N*	
Decora, standard size, stainless	84401-040	84409-040	
Decora Plus, standard size, polycarbonate	80301-0S*	80309-0S*	
Decora, midway, urea	80601-0S*	80609-0S*	
Decora, midway, nylon	PJ26-00*	PJ262-00*	

QUICKPORT® MULTIMEDIA WALLPLATE INSERTS			
DESCRIPTION	WHITE	LT. ALMOND	IVORY
6-Port Insert, polybag, standard carton	41646-00W	41646-00T	41646-00I
4-Port Insert, polybag, standard carton	41644-00W	41644-00T	41644-00I
<b>[C]</b> 3-Port Insert, polybag, standard carton	41643-00W	41643-00T	41643-00I
2-Port Insert, polybag, standard carton	41642-00W	41642-00T	41642-00I
<b>[D]</b> 1-Port Insert, polybag, standard carton	41641-00W	41641-00T	41641-00I
<b>[E]</b> HDMI Decora Insert, feedthrough	41647-00W	—	41647-00I
DVI Decora Insert, feedthrough	41648-00W	—	41648-00I

\* = Colors: Choose from any of the colors below.

WALLPLATE ACCESSORIES		
DESCRIPTION	PART NO.	
<b>[F]</b> QuickPort Shutter Kit (50 shutters)	51084-ICN	
White Label Kit	51084-XLB	
<b>[G]</b> Color Label Kit†	51084-CLB	
<b>[H]</b> Wallplate Mounting Brackets, single-gang, bulk polybag pack, 2 brackets per unit, rack pack carton	C0224-000	
<b>[I]</b> Wallplate Mounting Bracket, dual-gang, individual polybag pack, rack pack carton	C0225-0CP	

† = Color Label Kit includes grey, orange, red, yellow, green, blue, purple, and brown (2 sheets of each color). Also shown on page A68.



Note: 80301 and 80309 are not available in black or brown.



F, G



H, I



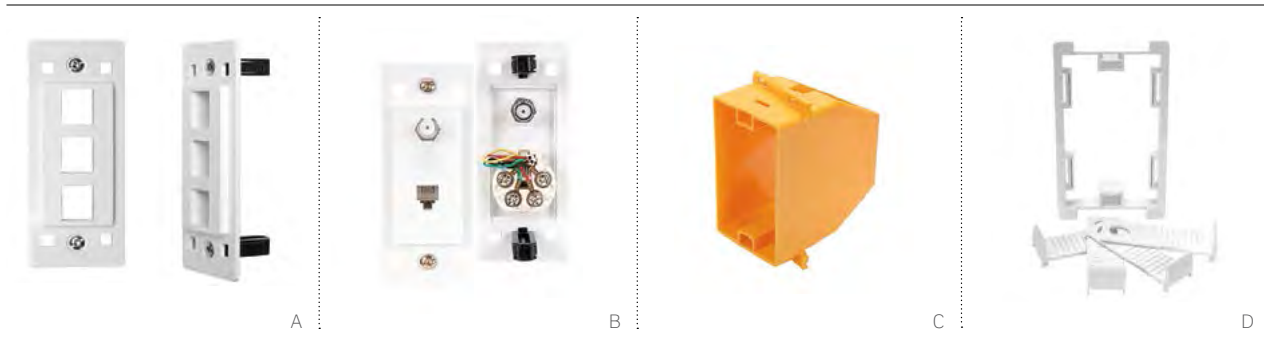

### CHEETAH SPEED SYSTEM

Install attractive phone, data, and video wallplates quickly and easily with the patented Cheetah Speed System. Using a revolutionary speed anchor with a snap and lock system, the Cheetah Speed System reduces installation time by up to 50%, while at the same time offering the elegance and style of screwless wallplates. Decora® inserts in 1-6 ports and wallplates for phone and coax are available in white, light almond, ivory, and black.

- Patented speed anchor enables devices and wallplates to be installed without screws
- Self-aligning inserts increase installation speed by up to 50%

#### CHEETAH SPEED SYSTEM INSERTS<sup>Δ</sup>

DESCRIPTION	WHITE	LT. ALMOND	IVORY	BLACK
<b>[A]</b> 3-Port Insert, includes blank insert	5020C-00W	5020C-00T	5020C-00I	5020C-00E
Decora Insert Coax	CH181-00W	CH181-00T	CH181-00I	CH181-00E
Decora Insert Telephone	CH149-00W	CH149-00T	CH149-00I	CH149-00E
<b>[B]</b> Decora Insert Telephone/ Coax Combo	CH159-00W	CH159-00T	CH159-00I	CH159-00E

#### CHEETAH SPEED SYSTEM BOXES & BRACKETS

DESCRIPTION	PART NO.
<b>[C]</b> Single-Gang Non-Metallic Datacom Box, multiples of 50	3005C-C00
<b>[D]</b> Single-Gang Low-Voltage Datacom Cut-in Bracket, multiples of 50	4007C-C00

Δ = Minimum order quantity and lead times may apply.



### SPOTLIGHT Cheetah Speed System



Leviton offers a complete line of Cheetah Speed System products including data and audio inserts, dimmers and fan controls, switches, receptacles, and a broad selection of screwless wallplates. The entire system uses the innovative, electrician-developed speed anchor system that enables devices to be installed without screws in a minimum of time.

To learn more, go to [leviton.com/cheetah](http://leviton.com/cheetah).

# MDU | In-Wall/Ceiling & Outdoor JBL® Speakers

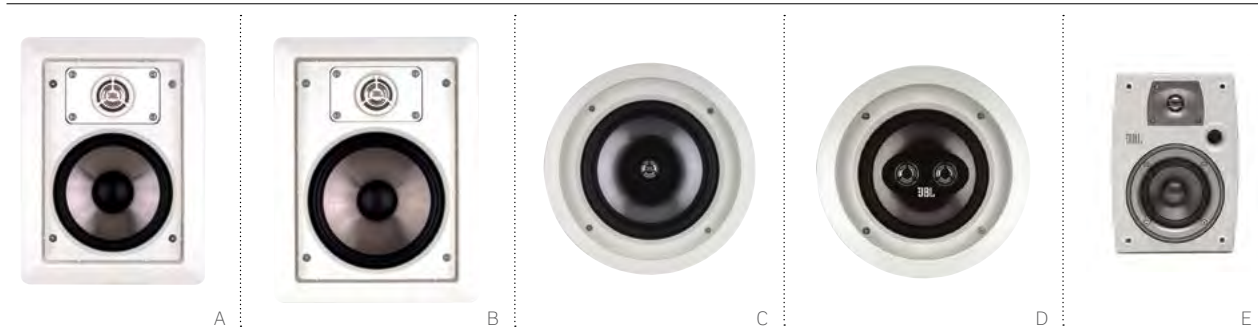

## LEVITON ARCHITECTURAL EDITION® POWERED BY JBL WALL & CEILING SPEAKERS



- JBL titanium-laminate drivers maintain accuracy and clarity even at frequency extremes
- Straight-Line Signal Path™ (SSP) crossover network for minimal signal distortion
- Long-excursion woofers with butyl-rubber half-round surrounds and extended pole-piece magnetic structures for maximum bass impact and dynamic range
- Low-diffraction, swivel-tweeter mounting system for optimum stereo imaging
- Heavy-duty push-type input terminals for long-term connection integrity
- Integrated dog-ear mounting brackets (optional rough-in kits available for installation in new homes)
- Acoustically transparent, paintable grills

## LEVITON ARCHITECTURAL EDITION POWERED BY JBL OUTDOOR SPEAKERS (mounting brackets included)

- Elliptical Oblate Spheroidal™ (EOS) Waveguide technology for high-frequency dispersion
- Straight-Line Signal Path (SSP) crossover networks for minimal signal distortion
- 5-way binding post input terminals for long-term connection integrity

## PRE-CONSTRUCTION KITS

- Pre-construction kits ensure that speaker locations and wiring are preserved and protected during construction, allowing for a cleaner, faster, and more precise installation during the trim-out stage
- Fire-Rated Back-Box enclosure meets fire code for MDU and residential installations

LEVITON ARCHITECTURAL EDITION POWERED BY JBL IN-WALL AND IN-CEILING SPEAKERS	
DESCRIPTION	PART NO.
<b>[A]</b> Pair of 6.5" Two-Way In-Wall Loudspeakers, 80 watts, 8 ohms	AEI65-000
<b>[B]</b> Pair of 8" Two-Way In-Wall Loudspeakers, 100 watts, 8 ohms	AEI80-000
<b>[C]</b> Pair of 6.5" Two-Way In-Ceiling Loudspeakers, 80 watts, 8 ohms	AEC65-000
Pair of 8" Two-Way In-Ceiling Loudspeakers, 100 watts, 8 ohms	AEC80-000
<b>[D]</b> 6.5" Two-Channel / Single Location Two-Way In-Ceiling Loudspeakers, two titanium tweeters, dual voice-coil titanium-laminate woofer 50 watts/channel, 8 ohms	AEM65-000
LEVITON ARCHITECTURAL EDITION POWERED BY JBL OUTDOOR SPEAKERS	
<b>[E]</b> Pair of Outdoor/All-Weather Two-Way Loudspeakers in Enclosure, 0.75" tweeter, 4" woofer, 150 watts, 8 ohms	AEN24-000
PRE-CONSTRUCTION KITS	
6.5" Pre-Construction Speaker Kit for in-wall installations	AEPI6-KIT
8" Pre-Construction Speaker Kit for in-wall installations	AEPI8-KIT
Fire-Rated Back-Box Enclosure (Required for 6.5" in-ceiling speakers AEC65, AEM65), (see page F28 for photo)	AEBC6-000



## SPEC-GRADE SOUND SPEAKERS

- AeroNylon tweeter diaphragm provides crystal-clear treble response and exceptionally accurate tracking of even the most challenging musical transients
- Built-in AutoSurge® circuit protection helps prevent speaker damage
- Advanced phase/time alignment guide properly aligns sound without misaligning the tweeters
- Precision dividing network ensures total audio signal electronic integrity up to the last microsecond before the signal is converted into sound
- Inert mounting frame with "dogleg" installation points eliminates any transmitted vibrations that could alter in-wall or in-ceiling sound quality
- Acoustically transparent, paintable grills



## LEVITON SPEC-GRADE SOUND OUTDOOR UTILITY TWO-WAY LOUDSPEAKERS

- 5.25" silicate-fiber cone low-frequency transducer with butyl rubber surround
- 5" poly-dome high-frequency transducer
- Element-resistant polypropylene enclosure, gold-plated binding terminals, and aluminum mounting bracket with stainless-steel hardware

## PRE-CONSTRUCTION KITS

- Pre-construction kits ensure that speaker locations and wiring are preserved and protected during construction, allowing for a cleaner, faster, and more precise installation during the trim-out stage
- Fire-Rated Back-Box enclosure meets fire code for MDU and residential installations

SPEC-GRADE SOUND IN-WALL/IN-CEILING INDOOR SPEAKERS	
DESCRIPTION	PART NO.
<b>[A]</b> Pair of 6.5" Spec-Grade Two-Way In-Ceiling Loudspeakers, 120 W peak/ 60 W RMS, 8 ohms	SGC65-00W
<b>[B]</b> Pair of 6.5" Spec-Grade Two-Way In-Wall Loudspeakers, 120 W peak/ 60 W RMS, 8 ohms	SGI65-00W
Replacement Grill for SGC65	SGC65-GRL
Replacement Grill for SGI65	SGI65-GRL
LEVITON SPEC-GRADE SOUND OUTDOOR/UTILITY LOUDSPEAKERS	
<b>[C]</b> Pair of Outdoor/Utility Two-Way Loudspeakers in Enclosure, 0.5" tweeter, 5.25" woofer, 120 watts, 8 ohms	SGO99-00W
Replacement Grill for SGO99-00W	SGO99-GRL
PRE-CONSTRUCTION KITS	
Rough-in Bracket for 6.5" In-Wall Loudspeakers	PCI65-KIT
<b>[D]</b> Fire-Rated Back-Box Enclosure (Required for 6.5" in-ceiling speakers SGC65)	AEBC6-000



## IN-WALL SPEAKERS

- Straight-Line Signal Path™ (SSP) crossover network for minimal signal distortion
- JBL® titanium-laminate drivers, pure titanium tweeter, and polymer-coated aluminum woofers maintain musical accuracy and clarity, even at frequency extremes
- Low-diffraction, swivel-tweeter mounting system of optimum stereo imaging

## SHELF-MOUNT CENTER CHANNEL SPEAKER

- Straight-Line Signal Path (SSP) crossover network for minimal signal distortion
- Dual 5" JBL PolyPlas cone woofers
- FreeFlow flared port for increased bass response without added port noise

## SUBWOOFER

- JBL PolyPlas™ woofer for low frequencies
- High-efficiency, high-current switching amplifier
- FreeFlow flared port for increased bass response without added port noise
- Built-in technologies allow simple adjustment for room acoustics and personal preference
- LFE and line level inputs for maximum connection flexibility

## SURROUND-SOUND HOME CINEMA SYSTEM

- Includes five two-way magnetically shielded satellite speakers with 2.5" (63.5 mm) woofer and 0.5" (12.7 mm) tweeter; one 8" (200 mm) 100-watt powered subwoofer with LFE and a built-in crossover network, plus five adjustable mounting brackets and subwoofer input RCA cable
- Five-channel system can be expanded to 6.1 or 7.1 surround sound with optional satellite speakers

### LEVITON ARCHITECTURAL EDITION® POWERED BY JBL HOME THEATER SPEAKERS

DESCRIPTION	PART NO.
<b>[A]</b> Dual 5" Two-Way In-Wall Center Channel Home Theater Loudspeakers, 120 watts, 8 ohms	AEI55-000
<b>[B]</b> Dual-Channel Two-Way Shelf-Mounted Center Channel Loudspeaker w/ silver grill, 75 watts / 300 watts, 8 ohms	AECCS-VCE
<b>[C]</b> Powered 12" Subwoofer w/ amplifier w/ silver grill, 400 watts RMS, 700 watts peak, 8 ohms	AESUB-012
<b>[D]</b> Five-Channel Surround-Sound Home Cinema Speaker System w/ 100-watt powered subwoofer and 5 satellite speakers	AEH50-0**
System-Matched Satellite Speaker for 6.1 and 7.1 surround-sound expansion	AESS5-0**
Single-Gang Decorative Satellite Speaker Adapter Wallplate/Bracket	AEPHK-0**
Pre-Construction Kit, in-wall center channel shelf for use with AEI55-000	AEPIS-KIT

\*\* = Color: Available in White (WH) or Black (BL).

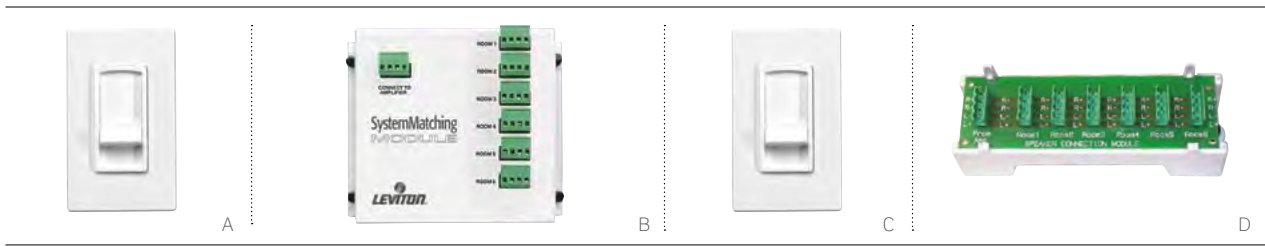

## DECORA® STRAUSS TRANSFORMER-FREE VOLUME CONTROLS

- Contemporary slider design brings precision and elegance to any installed audio system
- Available in standard and impedance-matched versions
- Volume control uses standard Decora wallplate in a standard J-Box or low-voltage mounting ring
- Color-change kits ensure the right finishing touch for every application

## 1X6 AUDIO DISTRIBUTION MODULE

- Combines with impedance-matching Volume Controls to control up to six speaker pairs from an amplifier or receiver
- Designed to mount in Leviton Structured Media enclosures and connect to six rooms/zones

## SYSTEM MATCHING MODULE

- Combine with non-impedance-matching Volume Controls to control up to six speaker pairs (cannot be used with impedance-matching volume controls)
- AutoSurge™ circuit technology protects speakers from potentially damaging transients
- Designed to mount in Leviton Structured Media® Enclosures

### AUDIO SYSTEM VOLUME CONTROLS

DESCRIPTION	PART NO.
<b>[A]</b> Decora Strauss Transformer-Free Slider Volume Control, analog, 200 watts peak, 100 watts RMS, 4-16 ohms, 8 ohm nominal (for use with SGAMP-000) (Decora wallplate sold separately, see page F25)	SGVST-00W
<b>[C]</b> Decora Strauss Transformer-Free Impedance-Matching Slider Volume Control, analog, 200 watts peak, 100 watts RMS, 4-16 ohms, 8 ohm nominal (for use with 48211-06A)	SGVSM-00W
Decora Strauss Color-Change Kit, converts to light almond	SGVCK-0LA
Decora Strauss Color-Change Kit, converts to ivory	SGVCK-00I
Decora Strauss Color-Change Kit, converts to black	SGVCK-00E

### SYSTEM MATCHING MODULE

<b>[B]</b> System Matching Module for impedance-matching passive two-channel multi-room audio systems (for use with SGVST-00W)	SGAMP-000
--	-----------

### 1X6 AUDIO DISTRIBUTION MODULE

<b>[D]</b> 1x6 Passive Audio Module (for use with SGVSM-00W)	48211-06A
--	-----------



## SPOTLIGHT | Impedance Matching Difference

When installing an audio system, it is important to have an impedance-matching component paired with a standard component. Failure to do so may have a negative effect on the audio system.

Do NOT use an impedance-matching volume control with an impedance-matching module, and do NOT use a standard volume control with a passive audio module. Doing so, in either instance, could damage the amplifier.





Mobile Device Station  
& USB Charger/Tamper-Resistant Receptacle

## HOME THEATER, MULTI-ROOM & SPEAKER WALLPLATES

- Designed for easy installation of cables using low-voltage rings and standard low-voltage junction boxes
- Home Theater Interface wallplate (AEHTK) accommodates 5.1 to 7.1 channel surround-sound systems, and features RCA connectors for subwoofer connection and two extra QuickPort® openings
- Multi-room Audio wallplate (AEMRK) accommodates left and right audio speakers (± connections), and two extra openings for additional QuickPort connectors (e.g., adding a subwoofer or 3.5 mm stereo phone jack)
- Speaker wallplate allows for simple, solderless connections to any home entertainment speaker system

## RECESSED ENTERTAINMENT BOX (REB)

- Affordable solution manages home theater electronics in a single location
- Ideal for new construction (stud-mounted) and retrofit (wall-mounted) applications
- Low-profile frame provides neat, recessed installation
- Optional high-profile cover includes sliding plastic front panels, and channels all wires through the bottom of the unit

## RECESSED RECEPTACLES

### Recessed Single-Gang Receptacle

- Fits most standard electrical boxes
- Supplies AC power for one or two components (flat panel TVs and video receiver)
- cULus Approved, code-compliant solution

### Recessed Dual-Gang Duplex Receptacle with Six QuickPort Openings

- Centralizes connection points for AC power, audio, video, data, and phone
- Includes plastic electrical box for use in new and retrofit construction
- UL Approved, code-compliant solution

## MOBILE DEVICE STATION

- Turns a receptacle outlet into a convenient storage location for smartphones and MP3 players
- Installs without creating any new holes in the wall
- Available in both Decora® and Renu® styles
- Integrated cable management keeps charging cables organized and protected
- Requires a Leviton wallplate, sold separately
- Ideal with Leviton USB charger/tamper-resistant receptacle

## USB CHARGER/TAMPER-RESISTANT RECEPTACLE

- USB ports with a combined power of 2.1A, ideal for charging tablets and other high-draw devices
- Compact design fits in a standard wallbox, is compatible with standard wallplates, and can be multi-ganged with other standard Leviton devices
- Back and side wired for easy installation
- Smart chip designed for recognizing and optimizing the charging requirements of your device
- Tamper-Resistant NEC® Compliant shutter mechanism blocks access to contacts from most foreign objects

## HOME THEATER AND MULTI-ROOM WALLPLATES

DESCRIPTION	PART NO.
<b>[A]</b> Home Theater Interface Wallplate, 14 gold-plated spring clips, two RCA connectors, two QuickPort® openings	AEHTK-000
<b>[B]</b> Multi-Room Install Wallplate, two gold-plated spring clips, two QuickPort openings	AEMRK-000
<b>[C]</b> Single-Gang Single Spring-Clip Device Audio/Video Wallplate, standard size, polymer break resistant, box mount	40951-1P*
<b>[D]</b> Single-Gang Double Spring-Clip Device Audio/Video Wallplate, standard size, polymer break resistant, box mount	40952-2P*

## RECESSED DEVICES & ENTERTAINMENT BOX

Single-Gang Recessed Single Receptacle 15A-125VAC, 2-Pole, 3-Wire — NEMA 5-15R, includes clock hanger hook	00688-00*
Single-Gang Recessed Single Receptacle, Non-Magnetic Stainless Steel 15A-125VAC, 2-Pole, 3-Wire — NEMA 5-15R, includes clock hanger hook	05261-0CH
<b>[E]</b> Single-Gang Recessed Duplex Receptacle 15A-125VAC, 2-Pole, 3-Wire — NEMA 5-15R	00689-00+
Single-Gang Recessed Single Receptacle, Non-Magnetic Stainless Steel 20A-125VAC, 2-Pole, 3-Wire — NEMA 5-20R, includes clock hanger hook	05361-0CH
<b>[F]</b> Dual-Gang Recessed Duplex Receptacle and Openings for six QuickPort Modules 15A-125VAC, 2-Pole, 3-Wire — NEMA 5-15R (four blank inserts included)	00690-00*
<b>[G]</b> Recessed Entertainment Box w/ Low-Profile Frame	47617-REB
Recessed Entertainment Box w/ High-Profile Cover	47617-RBH
High-Profile Cover	47617-HPC
Low-Profile Frame	47617-LPF
Replacement Snap-in Plates, 2 per bag	47617-PLT

## MOBILE DEVICE STATION & USB CHARGER / RECEPTACLE

<b>[H]</b> Decora® Mobile Device Station, White	47112-00W
Decora Mobile Device Station, Light Almond	47112-00T
Decora Mobile Device Station, Black	47112-00E
<b>[I]</b> Renu® Mobile Device Station, White on White	47112-RWW
Renu Mobile Device Station, Navajo Sand	47112-RNS
Renu Mobile Device Station, Onyx Black	47112-ROB
<b>[J]</b> USB Charger/Tamper-Resistant Receptacle	T5630-00W

\* = Color: White (W), Ivory (I)

† = Color: White (W), Lt. Almond (T), Ivory (I), Black (E)



Mobile Device Station Colors:



## A Culture of Ingenuity & Innovation

### RON SHACKELFORD

Applications Engineer

Ron provides applications engineering support for Leviton's MDU solutions, PDUs, and A/V products. He helped develop some of Leviton's latest products, including the Mobile Device Station, Enhanced MOS Modules, and e2XHD system. Ron also assists Leviton's team of technical service reps with customer support. When he's not working, he's spending time in his vineyard making wine or enjoying a movie on his home cinema, custom-built with Leviton connectivity.





SECTION

X

TECHNICAL INFORMATION



---

## SECTION X CONTENTS

GENERAL INFORMATION	<b>X3</b>	Web-Based Resources
	<b>X4</b>	Wiring Standards
	<b>X5</b>	Wire Color Codes & Pin Designations
	<b>X6</b>	USOC Codes
TERMINATION INSTRUCTIONS	<b>X7</b>	Copper Connector Termination
	<b>X10</b>	Fiber Connector Termination
	<b>X12</b>	Fan-Out Kit Assembly
SPLICE TRAYS	<b>X13</b>	Dimension & Selection Guide
UPDATE	<b>X14</b>	Adapter Plate Discontinuation
STANDARDS	<b>X15</b>	NEMA and IEC Classifications
	<b>X15</b>	Wallplate Materials
	<b>X16</b>	Applications
INDEX	<b>X17</b>	Term Index
	<b>X23</b>	Part Number Index

## TECHNICAL RESOURCES YOU'LL FIND AT **LEVITON.COM**

To find product information, simply type the product name or part number into the search tool at [leviton.com](http://leviton.com). You can also find extra technical assistance using the links below, including guides, drawings, videos, and more.



### 1. KNOWLEDGBASE & FORUMS

[communities.leviton.com](http://communities.leviton.com)

At Leviton's Knowledgebase, you can get answers to your technical questions or post your own inquiries. You'll find a unique community hub for Network Solutions as well as Leviton's other business units.

### 2. TRAINING VIDEOS

[leviton.com/ns/techlibrary](http://leviton.com/ns/techlibrary) & [youtube.com/LevitonMfg](http://youtube.com/LevitonMfg)

Leviton training videos and animations offer simple step-by-step instructions for installations and terminations. Videos include a Secure Keyed LC Fiber System overview, fiber and copper connector termination instructions, and techniques for using fiber optic fan-out kits.

### 3. BIM OBJECTS

[leviton.com/bim](http://leviton.com/bim)

Building Information Modeling (BIM) is an important program for design and project coordination in construction projects. Incorporate Leviton images and added intelligence into infrastructure design drawings with our library of free BIM objects.

### 4. VISIO® STENCILS

[leviton.com/visio](http://leviton.com/visio)

Download Microsoft® Visio stencils of Leviton products, including connectors and wallplates, copper and fiber components, residential/MDU products, and cable management solutions.

### 5. MANUALS & GUIDES

[leviton.com/ns/techlibrary](http://leviton.com/ns/techlibrary)

Here you'll find helpful material, such as the Patch Panel Selection Guide and popular CAT 6A Reference Guide, as well as installation manuals for Connected Home products.

### 6. NETWORK PLANNING TOOLS

[leviton.com/homeconfig](http://leviton.com/homeconfig) & [leviton.com/smallbiztool](http://leviton.com/smallbiztool)

Fill out a simple online questionnaire and our technical experts will quickly identify the products that meet the needs of your home or small business network.

### 7. MDU INSTALLATION DIAGRAMS

[leviton.com/connectedhome](http://leviton.com/connectedhome)

Find helpful wiring diagrams for multi-room audio and home theater MDU projects.

### 8. APPLICATION/TECH NOTES

[leviton.com/ns/techlibrary](http://leviton.com/ns/techlibrary)

Application notes provide extra instruction for using and installing products such as copper trunk cables, Fiber Raceway System, and 66 connecting blocks. Tech notes offer a deeper look into the unique technology behind many of our products.

### 9. INDEPENDENT TESTING INFORMATION

[leviton.com/ns/testresults](http://leviton.com/ns/testresults)

Find independent test results for Leviton products, including CAT 6A component performance, pre-terminated OM3 MTP® System performance, and channel performance of Leviton connectivity paired with qualified cables.

### 10. LITERATURE LIBRARY

[leviton.com/ns/litlibrary](http://leviton.com/ns/litlibrary)

Refer to our Lit Library for additional systems and product information, including brochures, case studies, line cards, spec sheets, and an electronic version of this catalog.

### 11. SPEC TOOLS

[leviton.com/specteam](http://leviton.com/specteam)

Download spec tools for use in bids, design plans, and specification documents at the Spec Team web page, including sample bid spec forms and RFP documents.

### 12. CUSTOMIZED PRODUCT SOLUTIONS

[leviton.com/configurator](http://leviton.com/configurator)

Configure enclosures, MTP cassettes, and fiber and copper cable assemblies through Leviton's Make-to-Order program.

### 13. LIVE CHAT

[leviton.com/support](http://leviton.com/support)

Get fast, easy help when you need it. Connect with Leviton's technical experts for a quick response and knowledgeable answers to your product and application questions.

### 14. EZ-LEARN™

[leviton.com/ezlearn](http://leviton.com/ezlearn)

Acquire the skills and abilities you need to compete in today's dynamic and ever-evolving electrical industry.

















## T568A OR T568B - WHICH ONE SHOULD YOU CHOOSE?

- If the installation is residential, choose T568A unless other conditions apply (see below).
- If there is pre-existing voice/data wiring (remodel, moves, adds, changes), duplicate the existing wiring scheme on any new connection.
- If project specifications are available, use the specified wiring configuration.
- If components used within the project are internally wired either T568A or T568B, duplicate this wiring scheme. Leviton residential applications use T568A in all of their circuit boards.

## STANDARDS

- TIA-568-C “Commercial Building Telecommunications Cabling Standard” lists both wiring configurations. T568B is the most prevalent for commercial installations.
- TIA-570-B “Residential Telecommunications Cabling Standards” recommends T568A.

## T568A & T568B WIRING STANDARDS IDC COLOR ASSIGNMENTS

JACK PIN #	T568A WIRE COLORS	JACK PIN #	T568B WIRE COLORS
1	White/Green 	1	White/Orange 
2	Green 	2	Orange 
3	White/Orange 	3	White/Green 
4	Blue 	4	Blue 
5	White/Blue 	5	White/Blue 
6	Orange 	6	Green 
7	White/Brown 	7	White/Brown 
8	Brown 	8	Brown 

For some cables, wires for jack pin numbers 2, 4, 6, and 8 may have a white stripe. This is equivalent to cables with solid wires for the same pin numbers.

## WIRING POTS (PLAIN OLD TELEPHONE SERVICE) WIRE TO CATEGORY-RATED WIRE

STANDARD 4-PAIR WIRING	
Pair 1	Tip - White/Blue Ring - Blue
Pair 2	Tip - White/Orange Ring - Orange
Pair 3	Tip - White/Green Ring - Green
Pair 4	Tip - White/Brown Ring - Brown

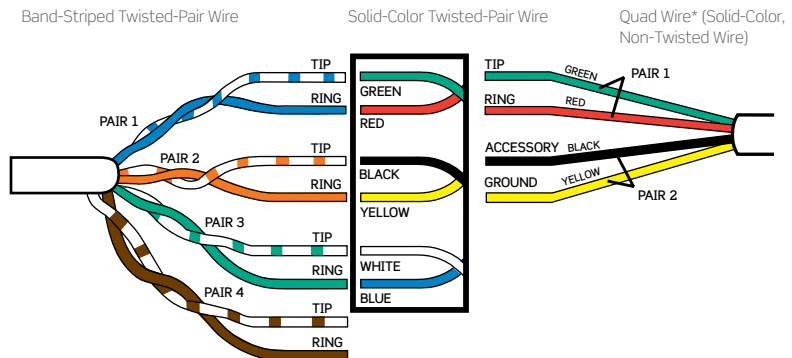

For 6-wire jacks use pair 1, 2, & 3 color codes. For 4-wire jacks use pair 1 & 2 color codes. For some cables, wire for even jack pin numbers may have a white stripe. This is equivalent to cables with solid wires for the same pin numbers.

**\*Caution:** Quad wire is no longer acceptable for installation in multi-line environments. If encountered during a retrofit, quad wire should be replaced with 100 ohm UTP. Connecting new quad to installed quad will only amplify existing problems and limitations associated with quad wire; leaving existing quad in place and connecting 100 ohm UTP to it may also be ineffective, as the quad wire may negate the desired effect of the UTP.

Visit [leviton.com/ns/support](http://leviton.com/ns/support) for more wiring diagrams and technical information.

# TECHNICAL INFORMATION | Wire Color Codes & Connector Pin Designations

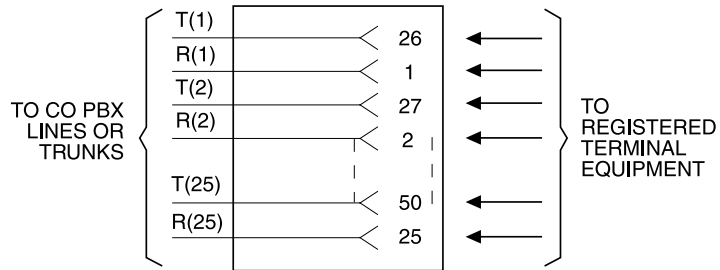
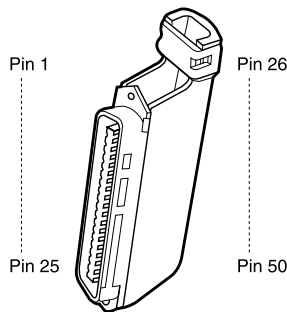

## WIRE COLOR CODES & PIN DESIGNATIONS

### Electrical Network Connection

From 1 to 25 single or multiple-pair circuits bridged to the network or other connected equipment.

### Mechanical Arrangement

Circuits are provided on numbered tip and ring positions on a miniature 50-pin ribbon telco connector (Amphenol™-type). Pins 1 (ring) and 26 (tip) are considered position 1. Pins 2 (ring) and 27 (tip) of the ribbon connector are position 2. This pairing continues through 25 pairs.

### Typical Usage

Many key and PBX systems specify the RJ-21X, or "Amphenol-type" as the network interface device. Many of these systems also use the RJ-21X as a connector for stations or telephone sets, wired from the KSU or PBX main distribution frame.

Many Leviton connectors can be used for the RJ-21X configuration where "intermixing" is permitted. Substitution of these special connectors is often both economical and practical. Contact Network Solutions tech support for information about versions to meet your requirements.

Sometimes an RJ-11 or RJ-14C can be installed in place of an RJ-21X. While many smaller systems that require only a few lines may show the RJ-21X as the "official" connector required under registration, less complex connectors such as the RJ-11 or RJ-14C can often be specified (perhaps in multiples). If the system requires only a few lines but the RJ-21X is specified on the registration label, under FCC Part 68 you may specify the RJ-11C, RJ-14C, RJ-25C, or RJ-61X instead.

Wire Color	1 R	T 26	Wire Color
Blue/White	1 R	T 26	White/Blue
Orange/White	2 R	T 27	White/Orange
Green/White	3 R	T 28	White/Green
Brown/White	4 R	T 29	White/Brown
Slate/White	5 R	T 30	White/Slate
Blue/Red	6 R	T 31	Red/Blue
Orange/Red	7 R	T 32	Red/Orange
Green/Red	8 R	T 33	Red/Green
Brown/Red	9 R	T 34	Red/Brown
Slate/Red	10 R	T 35	Red/Slate
Blue/Black	11 R	T 36	Black/Blue
Orange/Black	12 R	T 37	Black/Orange
Green/Black	13 R	T 38	Black/Green
Brown/Black	14 R	T 39	Black/Brown
Slate/Black	15 R	T 40	Black/Slate
Blue/Yellow	16 R	T 41	Yellow/Blue
Orange/Yellow	17 R	T 42	Yellow/Orange
Green/Yellow	18 R	T 43	Yellow/Green
Brown/Yellow	19 R	T 44	Yellow/Brown
Slate/Yellow	20 R	T 45	Yellow/Slate
Blue/Violet	21 R	T 46	Violet/Blue
Orange/Violet	22 R	T 47	Violet/Orange
Green/Violet	23 R	T 48	Violet/Green
Brown/Violet	24 R	T 49	Violet/Brown
Slate/Violet	25 R	T 50	Violet/Slate
Not Used			

25-Pair Color Coding/ISDN Contact Assignment RJ-21X

## CONTACT ASSIGNMENTS FOR PLUGS AND JACKS

(ISDN Assignment of Contact Numbers as Specified by ISO Document 8877: 1987 (E))

CONTACT NUMBER	TE	NT	POLARITY
1	Power source 3	Power sink 3	+
2	Power source 3	Power sink 3	-
3	Transmit	Receive	+
4	Receive	Transmit	-
5	Receive	Transmit	+
6	Transmit	Receive	-
7	Power sink 2	Power source 2	+
8	Power sink 2	Power source 2	-

For use in TE to TE interconnections, power source/sink 3 shall conform to the requirements specified in CCITT recommendation 1.430, section 9.2 for power source/sink 2.

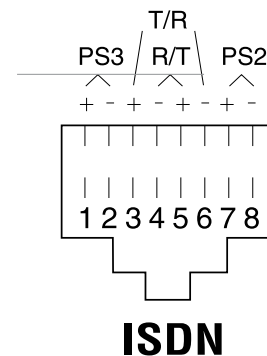

**ISDN**

Visit [leviton.com/ns/support](http://leviton.com/ns/support) for a detailed port-pin configuration chart.

## RJ-11C/RJ-11W - 6P2C

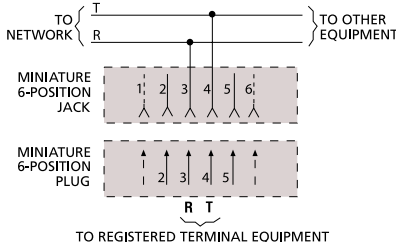

## RJ-14C/RJ-14W - 6P4C

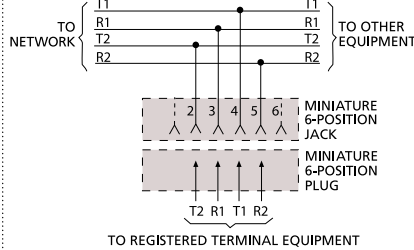

## RJ-25C - 6P6C

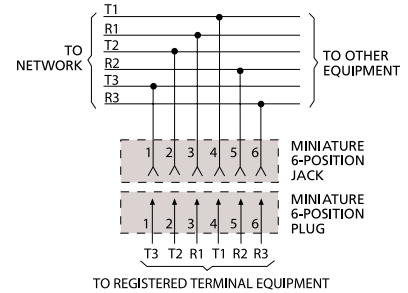

## RJ-31X

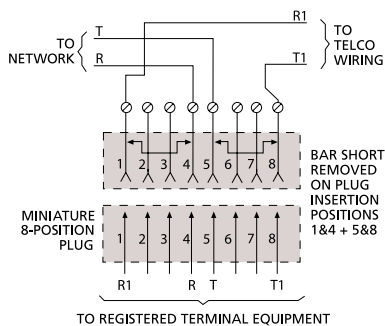

## RJ-38X

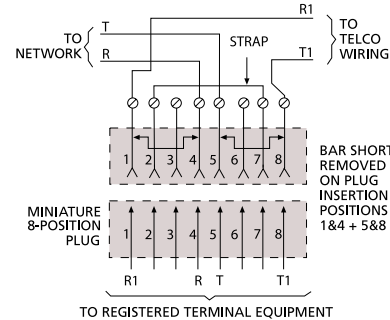

## RJ-45S

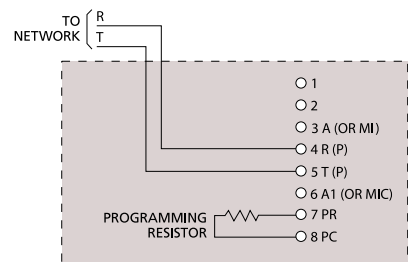

## RJ-48C

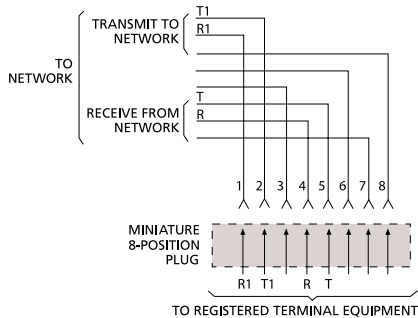

## RJ-48S

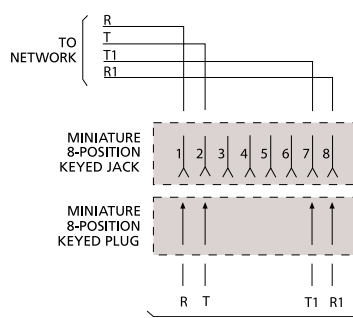

## RJ-48X

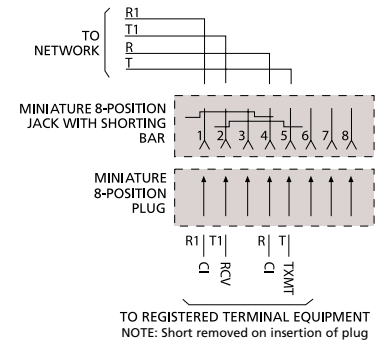

## RJ-61X

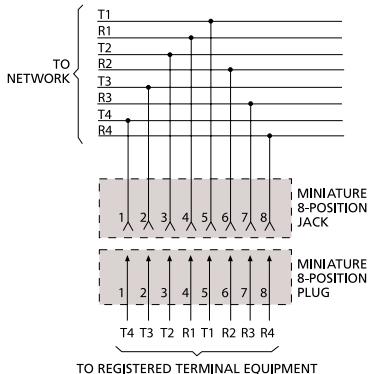

## USOC CODES

These Universal Service Order Codes (USOC) for connecting telephone instruments and related equipment to telephone lines are based on Part 68, Subpart F, Section 68.502 of FCC regulations, and as described by the T1E1.3 Working Group on Connectors and Wiring Arrangements.

USOC codes were developed years ago by the Bell operating companies to identify service or equipment under tariff. Information on USOC codes is provided here should you run across these in your work.

Registered RJ Jack numbers end with a letter that indicates the wiring or mounting method. "C" identifies a surface or flush-mounted jack, "W" identifies a wall-mounted jack, "X" identifies a complex multi-line or series-type jack, and "S" identifies a single-line jack.

# TERMINATION INSTRUCTIONS | CAT 6A/6 UTP Connectors

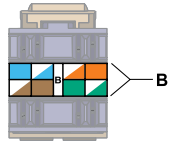

Figure A

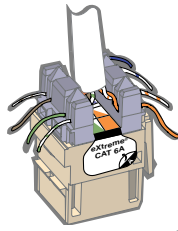

Figure B

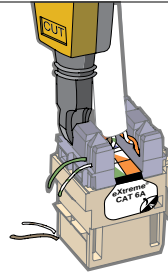

Figure C

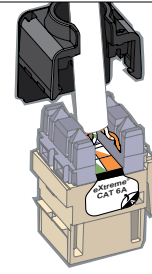

Figure D

## EXTREME® CAT 6A CONNECTOR TERMINATION INSTRUCTIONS

1. Remove about 3" of cable jacket and center spline (stiff plastic separator inside CAT 6A cable).
2. Determine whether to use wiring scheme T568A or T568B. Note the associated color codes and connector pin number on the label located between the IDC connector slots (Figure A). Peel back label for T568A wiring.
3. Leave the cable jacket within 1/8" of the connector side, then route the wires for termination using the selected wiring scheme (Figure B). Route cable perpendicular to the IDC field. Ensure there is enough slack in the twisted pairs, and do not place the cable jacket into the termination field. Use your fingers to carefully seat wires into the IDC slots. **Maintain wire-pair twisting to within 1/2" of the IDC.** Set a 110-style impact tool to low and position it perpendicular to the connector. Seat and trim the cable one pair at a time to prevent crushing the inside pairs (Figure C).
4. Place the Cone of Silence® over the terminated wires for secure connection and guaranteed CAT 6A performance (Figure D).

### T568A & T568B WIRING STANDARDS IDC COLOR ASSIGNMENTS

JACK PIN #	T568A WIRE COLORS	T568B WIRE COLORS
1	White/Green	White/Orange
2	Green	Orange
3	White/Orange	White/Green
4	Blue	Blue
5	White/Blue	White/Blue
6	Orange	Green
7	White/Brown	White/Brown
8	Brown	Brown

To help determine whether to use T568A or T568B, see page X4.

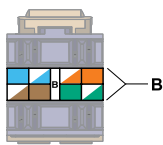

Figure A

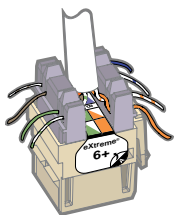

Figure B

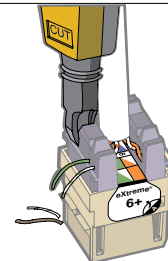

Figure C



Figure D

## EXTREME 6+ (CAT 6) & GIGAMAX® 5E+ (CAT 5E) CONNECTOR TERMINATION INSTRUCTIONS

1. Remove about 3" of cable jacket and center spline (stiff "t" shaped plastic separator inside cable).
2. Determine which wiring scheme to use, T568A or T568B. (See chart on page X4.) Note the associated color codes and connector pin numbers on the label located between the IDC connector slots (Figure A). Peel back label for T568A wiring.
3. Leave the cable jacket within 1/8" of the connector side, then route the wires for termination using the selected wiring scheme (Figure B). **Route cable perpendicular to the IDC field. Ensure there is enough slack in the twisted pairs, and do not place the cable jacket into the termination field.**
4. Use your fingers to carefully seat the wires into the IDC slots. Set a 110-style impact tool to low impact and position it perpendicular to the connector. **Maintain wire-pair twisting to within less than 1/2" of the IDC contact;** then, seat and trim the cable one pair at a time to prevent crushing the inside pairs (Figure C).
5. Place the dust cap over the terminated wires for secure connection (Figure D).

# TERMINATION INSTRUCTIONS | CAT 5e UTP & CAT 6A/6/5e Shielded Connectors

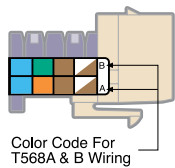

Figure A

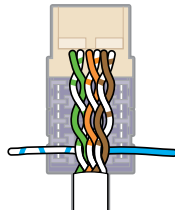

Figure B

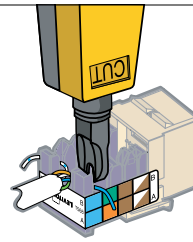

Figure C

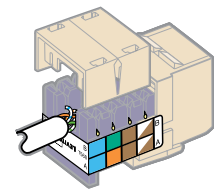

Figure D

## GIGAMAX® 5E (CAT 5E) & CATEGORY 5 CONNECTOR TERMINATION INSTRUCTIONS

1. Remove about 3" of jacket from the cable to expose the wires.
2. Determine which wiring scheme to use, T568A or T568B (see chart on page X4). Note the associated color codes and connector pin numbers as labeled on the sides of the connector (Figure A).
3. Route the wires for termination according to the chosen color code. Place the cutting side of the tool on the outside to trim the excess wire flush with the connector body as you punch the wires down (Figure B). Terminate and trim one pair at a time, starting from the rear of the connector (Figure C). Terminating each pair after placement will prevent crushing the inside pairs with the punchdown tool. **Maintain cable jacket as close to termination as possible.**
4. Place the dust cap over the terminated wires to ensure a secure connection and added strain relief (Figure D).
5. Noting the "UP" orientation of the connector, insert the terminated connector into the desired QuickPort® housing.

### T568A & T568B WIRING STANDARDS IDC COLOR ASSIGNMENTS

JACK PIN #	T568A WIRE COLORS	T568B WIRE COLORS
1	White/Green	White/Orange
2	Green	Orange
3	White/Orange	White/Green
4	Blue	Blue
5	White/Blue	White/Blue
6	Orange	Green
7	White/Brown	White/Brown
8	Brown	Brown

To help determine whether to use T568A or T568B, see page X4.

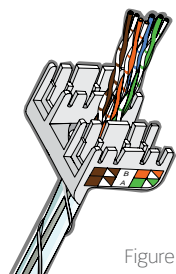

Figure A

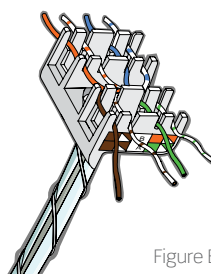

Figure B

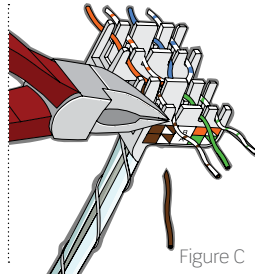

Figure C

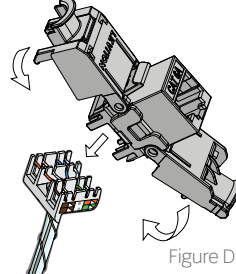

Figure D

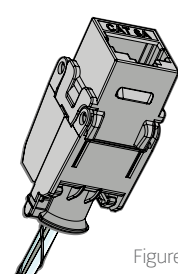

Figure E

## CAT 6A, 6 & 5E SHIELDED CONNECTOR TERMINATION INSTRUCTIONS

1. Strip a minimum of 1 inch of jacket from the end of the F/UTP cable. Pull the foil or braided shield back over the jacket as shown and wrap the drain wire around the shield. For U/FTP cable, fold the foil from each twisted pair over the jacket and wrap the drain wire around the shield.
2. Insert the wires from the stripped cable into the stuffer cap through the holes as shown (Figure A).
3. Insert the wires into their correct positions per the desired wiring scheme (Figure B).
4. Cut the excess wire off as close to the edge of the cap as possible using a flush cut tool (Figure C); tips of the wires should not protrude more than  $\frac{1}{32}$  of an inch.
5. Make sure the arrows on both connector and cap point in the same direction (Figure D).
6. Align the cap with the IDC towers and press into position (Figure D).
7. Rotate the wings toward each other until they snap closed (Figure D).
8. Ensure that the drain wire is wrapped around the connector strain relief. Cut off excess foil as close to the connector as possible (Figure E).
9. Tie-wrap the drain wire to the connector. Make the tie-wrap tight to ensure the drain wire does not come loose.

Note: This shielded connector is also compatible with other shielded cable constructions. (U/FTP, F/FTP, etc.)

# TERMINATION INSTRUCTIONS | Multimedia Outlet System VGA Modules

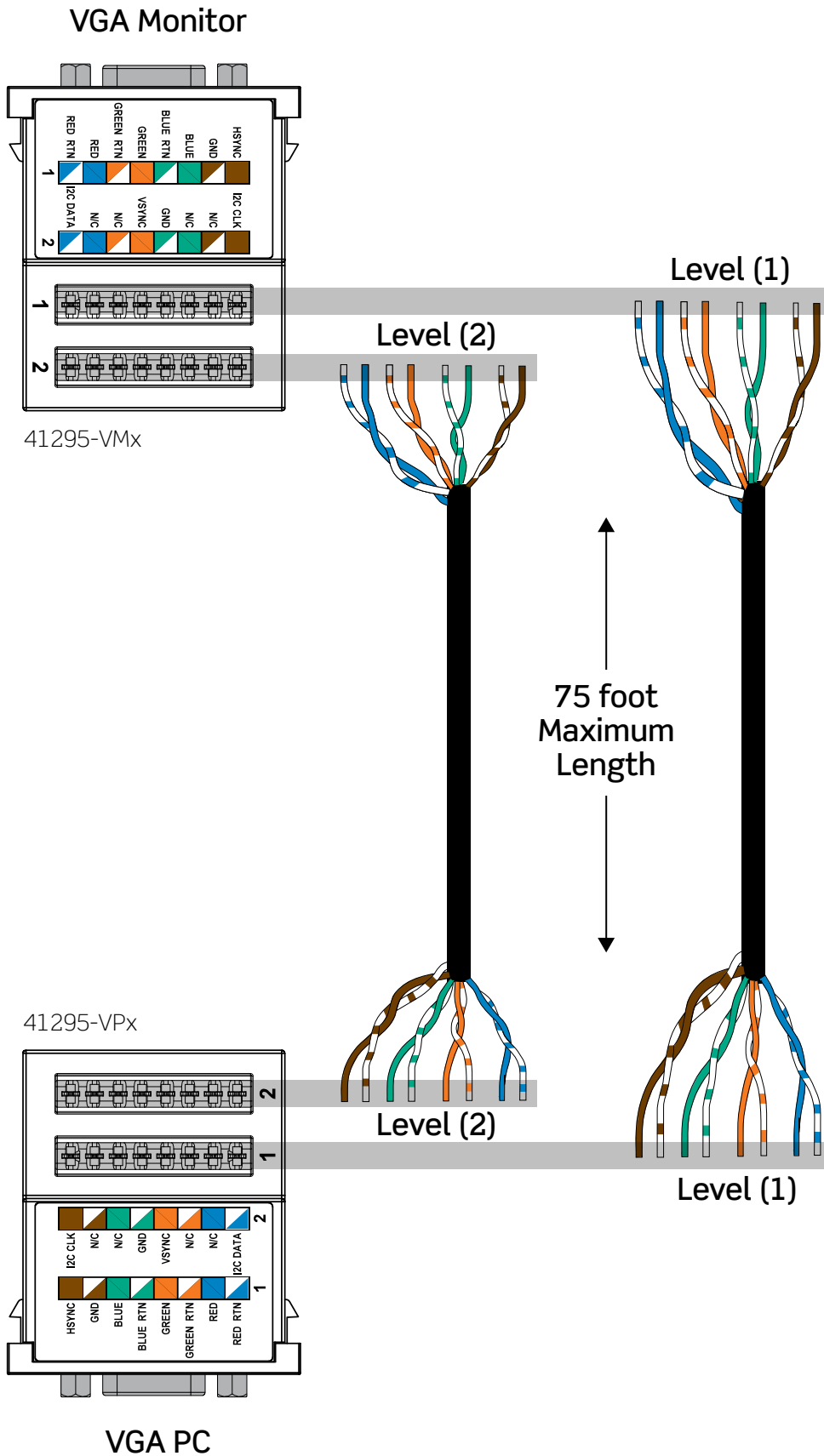

TECH INFO

termination instructions



# TERMINATION INSTRUCTIONS | FastCAM® Fiber Connector Termination

## FASTCAM SC, ST, & LC TERMINATION INSTRUCTIONS

These instructions should not be used with previous versions of the FastCAM SC, ST, and LC connectors, which are only used to terminate 250 µm and 900 µm fiber. (The SAN number on packaging will start with "0XX.")

Before beginning termination, identify the components of your connector tool kit. (See page B69 and B70 for options.) To ensure the FastCAM connector is prepared for termination, remove and reinstall the wedge clip and then press down on the clip at the ferrule side (first click) and then press down on the fiber insertion side (second click). See our install video at [leviton.com/videos](http://leviton.com/videos).

### FIBER TERMINATION – 250 µm

Tools required: LYNX or CT30A Cleaver\* and a fiber stripper. (See pg. B71)

1. Slide the protective tubing, 900 µm boot, and 250 µm protective tube (in order) onto the fiber.
2. Strip the fiber to a length of 40 mm by removing 10 mm at a time.
3. Clean the stripped fiber with an alcohol wipe to remove any debris. Check the fiber integrity by bending the stripped end slightly to 60°.
4. Set fiber onto cleaver such that 250 µm coating edge is at 10.5 mm position and cleave.
5. Wedge clips are engaged at shipment. If they have become dislodged, squeeze the top and bottom of the wedge clip, ensuring it is inserted in the connector body. A click will be heard for each wedge.
6. Slide the 250 µm protective tubing towards the end 250 µm coating.
7. Insert the cleaved fiber into the rear of the connector until the connection is made. Make a slight bend in the fiber to maintain connection.
8. OPTIONAL: Use the Visual Fault Locator (VFL) as an aid to determine that the cleaved fiber and stubbed fiber are connected properly.
- 8A. Remove the FastCAM connector dust cap and insert the connector into the VFL. Turn the VFL power on and there will be a red glow in Position 1 of the wedge clip.
- 8B. Insert the cleaved fiber into the rear of the connector until the red glow dims in Position 1 of the wedge clip. Make a bend in the fiber to maintain connection.
9. Maintaining a slight force on the fiber, release the wedge clip by squeezing both sides until the wedge clip dislocates itself from the connector body. Remove the wedge clip. If using a VFL, remove it from the connector and place the dust cap back onto the connector's ferrule.
10. Slide the boot up and over the rear of the connector body. Slide the clear 900 µm protective tubing - over the black 250 µm protective tubing - to the back of the connector's boot.
11. For ST connectors, push ST housing over body of connector to complete assembly.

### FIBER TERMINATION – 900 µm

When using a 900 µm Fan-out/Break-out kit to unjacketed 250 µm fiber, follow the manufacturer's instructions. After the kit is installed, use the following procedures for FastCAM termination.

Tools required: LYNX or CT30A Cleaver\* and a fiber stripper. (See pg. B71.)

1. Slide the 900 µm boot onto the fiber.
2. Strip the fiber to a length of 40 mm by removing 10 mm at a time.
3. From the end of the 900 µm buffered fiber, place a mark at 15.5 mm for SC/ST or at 11.5 mm for LC.
4. Clean the stripped fiber with an alcohol wipe to remove any debris. Check the fiber integrity by bending the stripped end slightly to 60°.
5. Set the stripped fiber onto the cleaver such that the 900 µm buffered fiber's edge is at the 10.5 mm position and cleave.
6. Wedge clips are engaged at shipment. If they have become dislodged, squeeze the top and bottom of the wedge clip, ensuring it is inserted in the connector body. A click will be heard for each wedge.
7. Insert the cleaved fiber into the rear of the connector until the connection is made and the mark is inside the connector. Make a slight bend in the fiber to maintain connection.

8. OPTIONAL: Use the Visual Fault Locator (VFL) as an aid to determine that the cleaved fiber and stubbed fiber are connected properly.
  - 8A. Remove the FastCAM connector dust cap and insert the connector into the VFL. Turn the VFL power on and there will be a red glow in Position 1 of the wedge clip.
  - 8B. Insert the cleaved fiber into the rear of the connector until the red glow dims in Position 1 of the wedge clip. Make a slight bend in the fiber to maintain connection.
  9. Maintaining a slight force on the fiber, release the wedge clip by squeezing both sides until the wedge clip dislocates itself from the connector body. Remove the wedge clip. If using a VFL, remove it from the connector and place the dust cap back onto the connector's ferrule.
- NOTE: The ferrule's dust cap should remain in place until you are ready to insert the connector.
10. Slide the boot up and over the rear of the connector body.
  11. For ST connectors, push ST housing over body of connector to complete assembly.

### FIBER TERMINATION – 2 mm and 3 mm

Tools required: LYNX or CT30A Cleaver\* and a fiber stripper. (See pg. B71.)

1. Slide 2 mm or 3 mm boot onto cable.
2. Remove 70 mm of cable jacket.
3. Strip the fiber to a length of 40 mm by removing 10 mm at a time.
4. From the end of the 900 µm buffered fiber, place a mark at 15.5 mm for SC/ST or a mark at 11.5 mm for LC.
5. Clean the stripped fiber with an alcohol wipe to remove any debris. Check the fiber integrity by bending the stripped end slightly at 60°. Set the stripped fiber onto the cleaver such that the 900 µm buffered fiber's edge is at the 10.5 mm position and cleave.
7. Wedge clips are engaged at shipment. If they have become dislodged, squeeze the top and bottom, ensuring the wedge clip is inserted into the connector body. A click will be heard for each wedge.
8. Insert fiber slowly into the connector until connection is made and marking is hidden. Form a slight bend in the fiber to maintain connection.
9. OPTIONAL: Use the Visual Fault Locator (VFL) as an aid to determine that the cleaved fiber and stubbed fiber are connected properly.
- 9A. Remove the FastCAM connector dust cap and insert the connector into the VFL. Turn the VFL power on and there will be a red glow in Position 1 of the wedge clip.
- 9B. Insert the cleaved fiber into the rear of the connector until the red glow dims in Position 1 of the wedge clip. Make a bend in the fiber to maintain connection.
10. Maintaining a slight force on the fiber, release the wedge clip by squeezing both sides until the wedge clip dislocates itself from the connector body. Remove wedge clip unit from connector. If using a VFL, remove it from the connector and place the dust cap back onto the connector's ferrule.
11. Fan Kevlar® around connector.
12. Grip Kevlar on both sides of the connector to maintain tension. Screw boot onto back of connector to fix Kevlar firmly.
13. Cut Kevlar from around the connector.
14. For ST connectors, push ST housing over body of connector to complete assembly.

\*Other cleavers with a guaranteed maximum 1° cleave angle for single-mode fibers and a maximum 2° cleave angle for multimode fibers provide acceptable results.

For additional tech tips on this product, visit [communities.leviton.com](http://communities.leviton.com).

# TERMINATION INSTRUCTIONS | Fast-Cure® Fiber Connector Termination

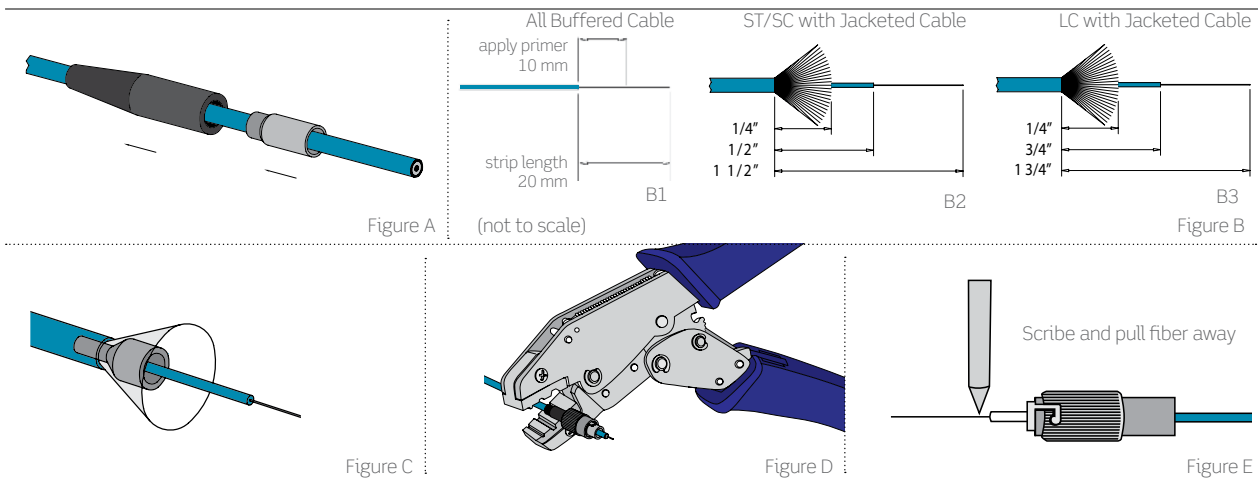

## FAST-CURE ASSEMBLY INSTRUCTIONS

### PREPARE - All Connector Types:

If using 900  $\mu$ m buffered fiber, do not use crimp tube in step 1.

- Slide boot and crimp tube onto fiber, small end inserted first. **(Fig. A)**  
**For 3 mm Jacketed Fiber:** Use ribbed boot, provided.  
**For 900  $\mu$ m Buffered Fiber:** Use smooth boot, provided. If using an SC connector on 900  $\mu$ m buffered fiber, you must install SC body into housing before continuing to step 2. Align body with connector housing, then insert body into housing until it snaps into place. Use dust cap to push body into housing.
- Strip jacket and/or buffer using the measurements provided in the figure above, stripping in increments of 1/4". If using jacketed cable, trim aramid strands as indicated above. **(Fig. B1-3)**
- Clean exposed fiber with a 99% isopropyl alcohol wipe, followed by a lint-free wipe, both before and after stripping.
- SC & FC Connector on 3 mm Jacketed Fiber ONLY:** Insert spacer over buffer and push until it contacts jacket. **(Fig. C)**

### ASSEMBLE - All Connector and Fiber Types:

- Remove the dust cap from the connector.
  - Dry fit the fiber by inserting it into the connector. This will ensure that all coating has been removed and the fiber can be inserted into the connector ferrule.
  - Shake the adhesive bottle before using. Remove the cap from the adhesive bottle, and attach the needle by pressing it gently onto the top of the bottle until you feel it set into place.
- NOTE: Syringes are also available for inserting adhesive.
- Insert the needle and firmly hold it against the back of the connector while filling it. Being careful not to overfill the connector, squeeze the bottle gently, injecting the adhesive into the connector. Continue until a dot of adhesive is visible at the other end, then remove the needle. Wipe away excess adhesive from the end of the ferrule.
  - Using the brush attached to the lid on the bottle of primer, apply the primer to the first 10 mm of the exposed fiber. **(Fig. B1)**
  - Insert the fiber into the back of the connector. To prevent premature bonding, use continuous motion until the fiber is fully seated in the connector. The primer will activate adhesive and begin the bonding process.

NOTE: The fiber should be inserted within 45 seconds of priming.

- Hold the fiber in place for 10-20 seconds, and allow up to 3 minutes for the adhesive to bond.
- If using any cable type but jacketed fiber, slide the boot back up over the back of the connector now. If using jacketed fiber, follow the steps below.

### Additional Steps For 3 mm Jacketed Cable ONLY:

- Arrange the aramid strands evenly around the end of the connector, then slide the crimp tube over the aramid strands and connector. Using a crimp tool, crimp the tube at both the large end (step 1) and the small end (step 2). **(Fig. D)**

**ST/SC - large end:** Use the .178" hex die.

**ST/SC - small end:** Use the .151" hex die.

**LC:** Use the .128" hex die.

### CLEAVE AND POLISH - All Connector and Fiber Types:

- When adhesive is cured (no longer wet), scribe fiber where it meets bead of adhesive at end of ferrule. **(Fig. E)**
- Pull fiber away from connector, then properly dispose of fiber debris.
- 12  $\mu$ m "AIR POLISH" FOR SM AND MM FIBER - Begin by "Air Polishing" connector with 12  $\mu$ m polishing film. Hold edge of film with thumb and forefinger. Gently touch connector to film and rotate using approximately 18-20 one-inch circles to remove fiber stub. Scraping sound of fiber on film will cease when polishing process is complete. 12  $\mu$ m film is dark pink in color.
- Holding a lint-free wipe across fingertips, gently press connector's endface against wipe. Twist connector in place to remove any debris. Do not drag connector across the lint-free wipe.
- 3  $\mu$ m POLISH FOR SM AND MM FIBER - Wipe the bottom surface of polishing puck and surface of polishing pad with a 99% isopropyl alcohol wipe.
- Place 3  $\mu$ m film on polishing pad, dull side up, then carefully set polishing puck on film. Gently insert connector into puck, and using light pressure, trace 15-20 "figure 8s" on film. Test to ensure fiber is completely polished.
- Also check to ensure that fiber is polished flush by dragging gently across lint-free wipe. Fiber should not snag. If fiber snags, continue polishing. Remove any debris using a lint-free wipe.
- Repeat steps 5 and 6 with the .3  $\mu$ m film. Leviton's 3  $\mu$ m film is yellow and .3  $\mu$ m film is light blue in color.

For additional tech tips on this product, visit [communities.leviton.com](http://communities.leviton.com).

# TERMINATION INSTRUCTIONS | Fiber Optic Fan-Out Kit

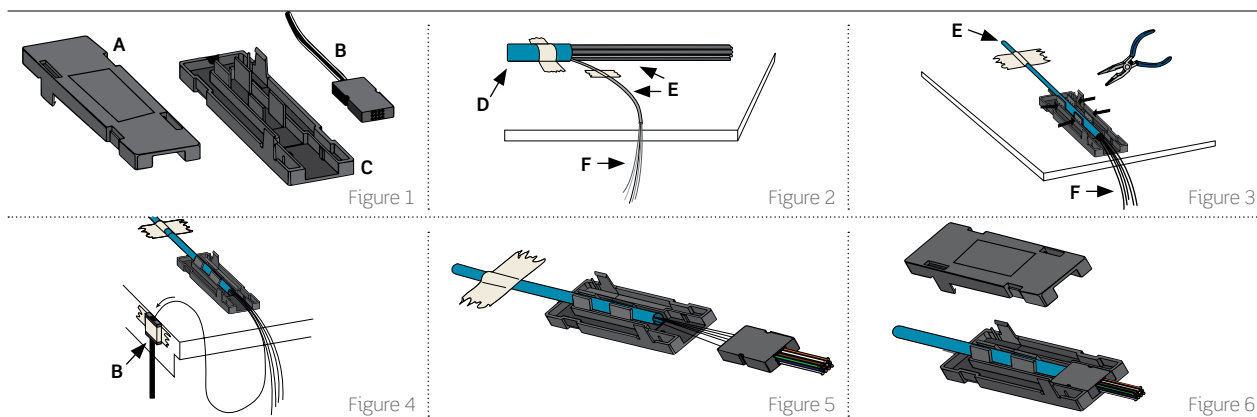

## FIBER OPTIC FAN-OUT KIT ASSEMBLY INSTRUCTIONS

Each kit breaks out 6 or 12 individual 250  $\mu\text{m}$  fibers from a loose buffered multifiber tube into individual 900  $\mu\text{m}$  buffer tubes. The fibers can then be terminated using the Thread-Lock® or Fast-Cure® Connector termination procedure for 250  $\mu\text{m}$  fiber.

One fan-out kit is required for each loose buffered multi-fiber tube being terminated. Leviton recommends you read these instructions thoroughly prior to installation of the fan-out kit.

### Contents (Figure 1):

- A. Top Cover
- B. 6- or 12-Fiber Terminal Assembly Unit (24" or 36")
- C. Base

### Recommended Tools (not included with Fan-Out Kit)

Electrical or Masking Tape  
Needle Nose Pliers  
Indelible Marker  
Buffer Tube  
Stripper

### Also Recommended Consumables (available in Leviton's Consumables Kit PN# 49800-FAN)

Silicone RTV Sealant  
Gel Cleaner  
Alcohol Pad  
Lint-Free Wipes  
Talc Powder

### Determining Strip Length

Locate your work surface as close to the enclosure location as possible, to minimize strip length. Route the cable sheath through the enclosure to the work surface.

On the cable sheath (D), measure the length of the fan-out tube (B) plus 6-12". Mark this length with a piece of tape - this is the strip point for the fiber cable sheath. (Figure 2)

### Cable End Preparation

Following your cable manufacturer's recommended stripping procedures, strip the cable sheath back to the tape mark. Secure the cable to the enclosure, then, using lint-free wipes or a gel cleaner, clean any dirt or gel surrounding the loose buffered multifiber tubes (E). (Figure 2)

NOTE: Quantities of loose buffered multifiber tubes may vary among cable manufacturers.

### Loose Buffered Fiber Tube Preparation

Measure the tube back 3" longer than your fan-out tube (B). Mark with an indelible marker, score, and strip, exposing the 250  $\mu\text{m}$  fibers (F) inside the buffer tube. Tape the buffered fiber tube to the work surface roughly 2" from the stripped end. (Figure 2) Wipe all gel from the exposed 250  $\mu\text{m}$  fibers using a gel cleaner.

Place buffered fiber in the base of the fan-out kit. Using needle nose pliers, press both pairs of the crimping fixture to hold the tube. Crimp only enough to start to deform the tube. Twist and pull the fan-out body to check if the crimp is secure. The tube should not slip or move in the crimp fixture. (Figure 3)

NOTE: For added retention, secure with a few drops of silicone RTV sealant on the crimp points of the fixture.

### Fiber Threading Procedure

Tape the terminal assembly unit (B) in the vertical position, 75 mm (3") to the side of the loose buffered fiber tube. (Figure 4)

Untangle the fibers and make sure they are completely free of gel filling compound. Leviton recommends using alcohol pads or gel cleaner to remove the gel.

NOTE: To more easily thread the fiber, cup talc powder in your hand and apply to the length of the fibers.

Starting with the blue fiber, thread 150 mm (6") of the fiber into the corresponding color tube of the terminal assembly unit (Figure 4). Repeat this procedure for the remaining fibers, making sure the color-coded fibers match the color-coded 900  $\mu\text{m}$  tubing.

When all the fibers have been threaded, push the fibers as a group until they start to protrude from the end of the 900  $\mu\text{m}$  fan-out tubes. Gently pull the fibers through the tubing, leaving sufficient slack so the fibers are not stressed. DO NOT PULL TAUT.

NOTE: While threading fibers through the 900  $\mu\text{m}$  tubing, gently pull the tubing straight with one hand to remove any coil.

Untape the terminal assembly unit and slide the assembly toward the loose buffered fiber tube while pulling the fibers from the end of the 900  $\mu\text{m}$  tubing. If the fibers twist, rotate the terminal assembly in the opposite direction of the twist. (Figure 5)

Place the terminal assembly unit into the mating feature in the base. For added protection, add a small bead of silicone RTV where the 250  $\mu\text{m}$  fibers enter the terminal assembly, securing the assembly and sealing the water-resistant gel (icky-pick) inside the fiber cable.

Align the top cover and snap into place (Figure 6). Remove the tape from the loose buffered fiber tube and repeat this procedure for any remaining loose buffered multifiber tubes. Once complete, snap the cover in place.

### Fiber Enclosure Installation

Hold the fan-out kit and buffered fiber together at the point where the tube enters the fan-out kit. Install terminated connector into respective adapter port. Route 900  $\mu\text{m}$  buffered fiber around cable managers (for slack and storage). Peel tape off adhesive (on bottom of base) and place between the cable managers (or where appropriate). Route loose tube subunit around cable managers (for slack and storage), and secure loose tube cable as required.

For additional tech tips on this product, visit [communities.leviton.com](http://communities.leviton.com).

# SPLICE TRAYS | Dimension & Selection Guide

## CHOOSING YOUR SPLICE TRAYS

Leviton offers several styles of metal and injection-molded splice trays. Use this chart to help determine which style will fit your specific needs. See pages B25, B37, and B38 for complete descriptions of splice trays, splice holders, and sleeves.

	Heat Shrink (Plastic Holders)	Heat Shrink (Foam Holders)	Bare Fusion	Opt-X® Ultra/1000i/500i (Rack Mount)	LightSpace® DPC/DPS (Rack Mount)	Opt-X® 1000 (Wall Mount)	LightSpace CPC/CPS (Wall Mount)	NIDS (Wall Mount)
<b>METAL SPLICE TRAY (0.35" HEIGHT)</b>								
12-fiber Mini, 4" W x 7" L	T47HS-P06		T47BF-P06	•	•	•	•	
12-fiber Mini, w/ standoff, 4" W x 7" L (0.57" Height)	5T000-00T			•	•	•	•	
12-fiber Standard, 4" W x 11.75" L	T4LHS-P06	T4LHS-F06	T4LBF-P06		•	•	•	
24-fiber High Density, 4" W x 11.75" L	T4LHS-P12	T4LHS-F12	T4LBF-P12		•	•	•	
12-fiber Standard, 5" W x 11.75" L	T5LHS-P06	T5LHS-F06	T5LBF-P06		•	•	•	
24-fiber High Density, 5" W x 11.75" L	T5LHS-B12	T5LHS-F12	T5LBF-P12		•	•	•	
<b>INJECTION-MOLDED SPLICE TRAY (MINI - 0.39" HEIGHT, HIGH DENSITY - 0.56" HEIGHT)</b>								
12-fiber Mini, 3.74" W x 5.59" L	T5PLS-12F			•		•	•	•
24-fiber High Density, 4.5" W x 7.63" L	T5PLS-24F			•		•	•	

See fiber enclosure section for splice tray capacity information.

# UPDATE | Precision-Molded Opt-X® Adapter Plates Replace Opt-X Metal Plates



Leviton has phased out many metal Opt-X Fiber Adapter Plates and replaced them with new polycarbonate Precision-Molded Opt-X Fiber Adapter Plates. The precision-molded design is eight times stronger than metal and provides a tight fit with integrated couplers. Precision-molded adapter plates are available as stand-alone units. Pre-loaded make-to-order enclosures are loaded with precision molded adapter plates.

Opt-X Metal Plate Description (Discontinued)	Discontinued Part Number	Opt-X Precision-Molded Plate Description (Replacement)	Replacement Part Number
3-pack Duplex SC MM (12-fiber), BEIGE, phos. bronze sleeve	5F100-3BC	Plate (beige), 62.5 µm MM (OM1), Duplex SC, 6-fiber, zirconia ceramic sleeve	5F100-6IC
NEW	-	Plate (black), 50 µm MM (OM2), Duplex SC, 6-fiber, zirconia ceramic sleeve	5F100-6EC
3-pack Duplex SC LOMM (12-fiber), AQUA, zirc. ceramic sleeve	5F100-3AC	Plate (aqua), 50 µm LOMM (OM3 & 4), Duplex SC, 6-fiber, zirconia ceramic sleeve	5F100-6QC
3-pack Duplex SC SM (12-fiber), BLUE, zirc. ceramic sleeve	5F100-3ZC	Plate (blue), SM (OS1 & 2), Duplex SC, 6-fiber, zirconia ceramic sleeve	5F100-6LC
3-pack Duplex SC SM (12-fiber), GREEN, zirc. ceramic sleeve	5F100-3CA	Plate (green), SM/APC (OS1 & OS2), Duplex SC, 6-fiber, zirconia ceramic sleeve	5F100-6VC
6-pack Duplex SC MM (12-fiber), BEIGE, phos. bronze sleeve	5F100-6BC	Plate (beige), 62.5 µm MM (OM1), Duplex SC, 12-fiber, zirconia ceramic sleeve	5F100-2IC
NEW	-	Plate (black), 50 µm MM (OM2), Duplex SC, 12-fiber, zirconia ceramic sleeve	5F100-2EC
6-pack Duplex SC LOMM (12-fiber), AQUA, zirc. ceramic sleeve	5F100-6AC	Plate (aqua), 50 µm LOMM (OM3 & 4), Duplex SC, 12-fiber, zirconia ceramic sleeve	5F100-2QC
6-pack Duplex SC SM (12-fiber), BLUE, zirc. ceramic sleeve	5F100-6ZC	Plate (blue), SM (OS1 & 2), Duplex SC, 12-fiber, zirconia ceramic sleeve	5F100-2LC
6-pack Duplex SC SM (12-fiber), GREEN, zirc. ceramic sleeve	5F100-6CA	Plate (green), SM/APC (OS1 & OS2), Duplex SC, 12-fiber, zirconia ceramic sleeve	5F100-2VC
6-pack Duplex LC MM (12-fiber), BEIGE, phos. bronze sleeve	5F100-12P	Plate (beige), 62.5 µm MM (OM1), Duplex LC, 12-fiber, zirconia ceramic sleeve	5F100-2IL
NEW	-	Plate (black), 50 µm MM (OM2), Duplex LC, 12-fiber, zirconia ceramic sleeve	5F100-2EL
6-pack Duplex LC LOMM (12-fiber), AQUA, zirc. ceramic sleeve	5F100-12A	Plate (aqua), 50 µm LOMM (OM3 & 4) Duplex LC, 12-fiber, zirconia ceramic sleeve	5F100-2QL
6-pack Duplex LC SM (12-fiber), BLUE, zirc. ceramic sleeve	5F100-12Z	Plate (blue), SM (OS1 & 2), Duplex LC, 12-fiber, zirconia ceramic sleeve	5F100-2LL
6-pack Duplex LC SM (12-fiber), GREEN, zirc. ceramic sleeve	5F100-12V	Plate (green), SM/APC (OS1 & OS2), Duplex LC, 12-fiber, zirconia ceramic sleeve	5F100-2VL
6-pack QUAD LC MM (24-fiber), BEIGE, phos. bronze sleeve	5F100-24P	Plate (beige), 62.5 µm MM (OM1), Quad LC, 24-fiber, zirconia ceramic sleeve	5F100-4IL
NEW	-	Plate (black), 50 µm MM (OM2), Quad LC, 24-fiber, zirconia ceramic sleeve	5F100-4EL
6-pack QUAD LC LOMM (24-fiber), AQUA, zirc. ceramic sleeve	5F100-24A	Plate (aqua), 50 µm LOMM (OM3 & 4) Quad LC, 24-fiber, zirconia ceramic sleeve	5F100-4QL
6-pack QUAD LC SM (24-fiber), BLUE, zirc. ceramic sleeve	5F100-24Z	Plate (blue), SM (OS1 & OS2), Quad LC, 24-fiber, zirconia ceramic sleeve	5F100-4LL
6-pack ST MM (6-fiber), phos. bronze sleeve	5F100-1ST	Plate (black), ST MM/SM, 6-fiber, zirconia ceramic sleeve	5F100-6MT
6-pack ST SM (6-fiber), zirc. ceramic sleeve	5F100-6ZT	Plate (black), ST MM/SM, 6-fiber, zirconia ceramic sleeve	5F100-6MT
8-pack ST MM (8-fiber), phos. bronze sleeve	5F100-8ST	Plate (black), ST MM/SM, 8-fiber, zirconia ceramic sleeve	5F100-8MT
8-pack ST SM (8-fiber), zirc. ceramic sleeve	5F100-8ZT	Plate (black), ST MM/SM, 8-fiber, zirconia ceramic sleeve	5F100-8MT
Blank Plate, plastic	5F100-BPP	Plate (BLACK), Blank	5F100-PLT
Blank Plate, metal	5F100-BLK	Plate (BLACK), Blank	5F100-PLT

## NEMA AND IEC ENCLOSURE CLASSIFICATIONS

### NEMA and IEC Enclosure Classifications Comparing NEMA Enclosure Type Numbers and IEC Enclosure Classification Designations (IP Suitability Rating)

#### NEMA

NEMA Standards Publication 250 defines the NEMA Enclosure Type Numbers. Unlike the IEC Enclosure Classification Designations, NEMA Standards Publication 250 tests for environmental conditions such as corrosion, rust, icing, oil, and coolants. For this reason, and because the tests and evaluations for other characteristics are not identical, the IEC Enclosure Classification Designations cannot be exactly equated with NEMA Enclosure Type Numbers. The table below provides an equivalent conversion from NEMA Enclosure Type Numbers to IEC Enclosure Classification Designations. Note that the NEMA Types meet or exceed the test requirements for the associated IEC Classifications. Therefore, this table cannot be used to convert from IEC Classifications to NEMA Types.

#### IEC

IEC Publication 529, "Classification of Degrees of Protection Provided by Enclosures," defines the IP (Ingress Protection) Suitability Rating. The IP Suitability Rating is a system for classifying the degree of protection provided by enclosures of electrical equipment. The higher the number in the rating, the greater the degree of protection provided by the enclosure. The first numeral of the code indicates the degree of protection for persons against access to hazardous parts inside the enclosure and/or against the ingress of solid foreign objects. The second numeral indicates the degree of protection of equipment inside enclosures against damage from the ingress of water. The IP Suitability Rating defined by IEC 529 does not specify any degree of protection against mechanical damage of equipment, risk of explosions, or conditions such as moisture (i.e., condensation), corrosive vapors, fungus, or vermin.

#### CONVERTING NEMA TO IEC

NEMA Enclosure Type Number	Equivalent IEC Enclosure Classification Designation
1	IP10
2	IP11
3	IP54
3R	IP14
3S	IP54
4 and 4X	IP56
5	IP52
6 and 6P	IP67
12 and 12K	IP52
13	IP54

#### IEC INGRESS PROTECTION RATING

Protection against solid objects	
0	None
1	Solid objects larger than 50 mm
2	Solid objects larger than 12.5 mm
3	Solid objects larger than 2.5 mm
4	Solid objects larger than 1.0 mm
5	Dust
6	Dust tight

Protection against water	
0	None
1	Vertically falling water drops
2	Vertically falling water drops (up to 15° angle)
3	Spraying water
4	Splashing water
5	Water jets
6	Powerful water jets
7	Temporary immersion in water
8	Continuous immersion in water

#### WALLPLATE MATERIALS

The material used to manufacture a wallplate will have a significant impact on the product's durability and suitability for certain applications.

##### THERMOSET

Thermoset products are manufactured by applying pressure to powdered material. These types of products do not provide a high degree of resistance to impacts, chemicals, and solvents; therefore they are not suitable for heavy-duty applications. Urea is a thermoset material, and is commonly used to manufacture wallplates for use in residential or light-duty commercial applications.

##### THERMOPLASTIC

Thermoplastic products are manufactured by heating pellets of material into a liquid for injection into a mold. These materials are the preferred choice for heavy-duty applications because they provide superior resistance to impact, chemicals, and solvents. ABS, nylon, and polycarbonate are thermoplastic materials, which are used to manufacture wallplates for use in commercial applications.

##### STAINLESS STEEL

Leviton manufactures wallplates from type 304 and type 430 stainless-steel materials. Type 430 stainless steel is resistant to the corrosion effects of moisture, and as such is suitable for exterior or wet applications. Type 430 stainless steel has magnetic properties that may interfere with certain equipment, such as hospital MRI and marine navigation equipment. Type 304 stainless steel is non-magnetic and is also more corrosion resistant than type 430 stainless steel, and as such is the preferred choice for commercial applications. All QuickPort® and telephone wallplate products are manufactured from type 304 stainless-steel material. Standard wallplates are also available in type 304 stainless-steel material by using the suffix "040" in the part number.

**Leviton products and guidelines are developed consistent with all known applicable practices as defined by the following:**

- TIA-568-C.0: Generic Telecommunications Cabling for Customer Premises
- TIA-568-C.1: Commercial Building Telecommunications Cabling Standard
- TIA-568-C.2: Telecommunications Cabling, Copper Component, and Cabling Specifications
- TIA-568-C.3: Telecommunications Cabling, Fiber Component, and Cabling Specifications
- TIA-569-B: Commercial Building Standard for Telecommunications Pathways and Spaces
- TIA-606-B: Administration Standard for Telecommunications Infrastructure of Commercial Buildings, published June 2012
- TIA-942-2: Telecommunications Infrastructure Standard for Data Centers
- ANSI-J-STD-607-A: Commercial Building Grounding and Bonding Requirements for Telecommunications
- IEEE 802.3: Ethernet-based LANs (Fast Ethernet, Gigabit Ethernet, 10 Gigabit Ethernet)
- IEEE 1100: Recommended Practice for Powering and Grounding Electronic Equipment
- ISO 11801: Generic Cabling for Customer Premises (multiple standards)
- ISO/IEC 15018 Edition 1.0: Generic Cabling for Homes
- ISO/IEC 24764 Edition 1.0: Generic Cabling Systems For Data Centres
- ISO/IEC 14763-2 Edition 1.0: Implementation and Operation of Cust. Premises Cabling - Planning and Installation
- ISO/IEC 14763-3 Edition 1.1: Implementation and Operation of Cust. Premises Cabling - Testing of Optical Fibre Cabling
- National Electrical Safety Code (NESC): Published by IEEE
- National Electric Code (NEC, NFPA 70): Published by NFPA
- BS EN 50173: Information Technology, Generic Cabling Systems, General Requirements (British Adopted European Standard)
- Telecommunications Distribution Methods Manual (TDMM): Published by BICSI
- Underwriters Laboratories (UL): Applicable listings and ratings
- NECA/BICSI 607-2011, Standard for Telecommunications Bonding and Grounding Planning and Installation Methods for Commercial Buildings
- ANSI/BICSI 002-2011, Data Center Design and Implementation Best Practices
- ANSI/BICSI 001-2009, Information Transport Systems Design Standard for K-12 Educational Institutions
- ANSI/BICSI 004-2012, Information Technology Systems Design and Implementation Best Practices for Healthcare Institutions and Facilities - Printed
- ANSI/NECA/BICSI 568-2006, Standard for Installing Commercial Building Telecommunications Cabling
- ANSI/BICSI 005-2013, Electronic Safety and Security (ESS) System Design and Implementation Best Practices
- Building Automation Systems cabling standard, ANSI/TIA-862-A-2011
- Residential Cabling standard, ANSI/TIA-570-C-2012
- A/V Design Reference Manual (AVDRM)
- BICSI ITS Dictionary
- Electronic Safety and Security Design Reference Manual (ESSDRM)
- Information Transport Systems Installation Methods Manual (ITSIMM)
- Outside Plant Design Reference Manual (OSPDRM)
- Telecommunications Distribution Methods Manual (TDMM)

TERM	PAGE
<b>110-Style Wiring Products</b>	A20-A24
<b>110-Style/Universal Patch Panels</b>	A13-14, A16-167, A20
<b>3.5 mm QuickPort® Stereo Adapter</b>	A42
<b>4500 Series PDUs</b>	D14
<b>5500, 5505 Series PDUs</b>	D13
<b>66 Blocks &amp; Accessories</b>	A26
<b>Adapter Plates, Fiber</b>	
LightSpace®	B35-B36
Opt-X®	B21-B22
HDX	B9-B10, B14
<b>Adapters</b>	
A/V	A42, A46
Fiber	B64, B66
<b>Array Cords</b>	B54
<b>Audio, Home</b>	
Home Theater Wallplates	F31-F32
JBL®	F27, F29
Leviton Architectural Edition®	F27, F29
Speakers	F27-F29
Volume Controls	F30
<b>A/V (Audio/Video)</b>	
Adapters	A42, A46
Connectors	See Connectors, A/V
Mounting Plates, Structured Media®	F15-F16
Multimedia MDU Wallplates	F23-F25
<b>Back Boxes</b>	A53-A54, F27-F28
<b>Banana Jack Connectors</b>	A42, F22
<b>Bezels</b>	A39
<b>Binding Post Connectors</b>	A42, F22
<b>Blank Adapter Plates</b>	B14, B22, B36
<b>Blank Inserts, QuickPort</b>	A42
<b>Blank Panels, Rack-Mount</b>	A14, C15, C17
<b>BNC Connector</b>	A42, F22
<b>Brackets</b>	
Fiber (MTP®)	B44
Furniture	A53-A54
Hinged (cable management)	C18

TERM	PAGE
Structured Media Enclosure	F5-F12
Wallplate Mounting	F25
<b>C1 Ultra Composite Patch Panels</b>	A14
<b>Cable Assemblies, Copper</b>	
Copper Trunk Terminated to e2XHD Cassette	A18, A32
Low Smoke Zero Halogen	A28-A29, A31-A32
Patch Cords	A28-A29
Patch Cords, Intact™ Intelligent	E6
Patch Cords, MDU	F15
Secure RJ	A33-A34, E5
Shielded	A28-A29, A31
Trunks	A31-A32
<b>Cable Assemblies, Fiber</b>	
Array Cords (Opt-X® Unity 40/100G)	B54
Harnesses	B44, B51-B53
Patch Cords	B54-B58
Pigtails	B55, B57-B58
Secure Keyed LC	B50, B53, B58, E6
Trunks	B5-B6, B46-B50
<b>Cable Management</b>	
110-Style (Cross Connect)	A25
Brackets	C18
Fiber Raceway System (duct)	C5-C12
Horizontal 19" Rack-Mount	C15
Overhead Infrastructure Platform	C3-C4
Rear Managers	C16
Rings	C18
VELCRO® Brand Fasteners	C19-C20
Vertical (Versi-Duct®) Rack-Mount	C13-C14
<b>Cassettes, MTP (Modules)</b>	B9-B10, B13-B14, B15-B20, B23-B24, B27-B30, B44
<b>Category 5e</b>	See GigaMax® CAT 5e
<b>Category 6</b>	See eXtreme® CAT 6
<b>Category 6A</b>	See eXtreme CAT 6A
<b>CATV Splitters</b>	F6, F21
<b>Cheetah Speed System®</b>	F26
<b>Cleavers, Fiber</b>	B69-B71



TERM	PAGE
<b>Compression Connectors</b>	A44, F22
<b>Connector Adapter Bezels</b>	A39
<b>Connectors, A/V</b>	A41-A46, F22
<b>Connectors, A/V - MOS (Multimedia Outlet System)</b>	A10, A45-A46, F22
<b>Connectors, Copper (jacks)</b>	
CAT 3	A39, F22
CAT 5	A39, F22
CAT 5e	A6, A38, A40,
CAT 6	A5, A38, A40
CAT 6A	A3-4, A37, A40
Floor	A51
Multimedia Outlet System (MOS)	A10, A45-A46, B65-B66
QuickPack®	A38
Shielded	A7, A40
Termination Instructions	X7-X12
Voice-Grade/USOC	F22
<b>Connectors, Fiber</b>	
FastCAM®	B60
Fast-Cure®	B61
Multimedia Outlet System (MOS)	B65-B66
Secure Keyed LC	B62
<b>Consumables, Fiber</b>	B72
<b>Cross-Connect Products</b>	
110-Style Wiring Products	A22-A25
66 Blocks & Accessories	A26
<b>Custom-Configured Products</b>	See Make-to-Order
<b>Decora®</b>	
A/V Inserts	A42, A46
QuickPort® Inserts & Floor Box Assemblies	A44, A42, A51
Telephone & Video Jacks/Inserts	A60
Volume Controls (MDU)	F30
Wallplates	A63
<b>Duct, Fiber (Fiber Raceway System)</b>	C5-C12
<b>Duplex Devices</b>	
Outlet-style Inserts (QuickPort)	A51
Wallplates	A64
<b>DuraPort® Industrial Connectivity</b>	A55-A56
<b>DVI Decora Insert, feedthrough</b>	A42

TERM	PAGE
<b>e2XHD Patching System</b>	A8, A18, B27-B30
<b>Enclosures, Rack-Mount - Fiber</b>	
High-Density Flush-Mount	B18, B39-B40
LightSpace® DP/DPS/DPC	B32
Opt-X® 1000i/500i	B17-B18
Opt-X HD	B12-B14
Opt-X Ultra®	B16
Replicator®	B43
VertiGO®	B20
<b>Enclosures, Structured Media®</b>	F5-F12
<b>Enclosures, Wall-Mount - Fiber</b>	
LightSpace CPC	B33
LightSpace CPS	B33
LightSpace NIDS	B34
Opt-X 1000	B19
<b>Enclosures, Zero-U - Fiber</b>	
VertiGO	B20
<b>Enclosures, Wireless</b>	C22
<b>Enclosures, Zone</b>	C21
<b>Excella® Wallplates &amp; Inserts</b>	A57
<b>Expansion Boards, Structured Media</b>	F19-F20
<b>eXtreme® CAT 6</b>	
Cable Assemblies	See Cable Assemblies, Copper
Connectors	A5, A38, A40
Cross Connect	A22
Patch Panels	See Patch Panels, Copper
System Overview	A5
<b>eXtreme CAT 6A</b>	
Cable Assemblies	See Cable Assemblies, Copper
Connectors	A3-A4, A37, A40
Cross Connect	A22
Patch Panels	See Patch Panels, Copper
System Overview	A3-A4
<b>F-Connectors</b>	A43-A44, A51, A59-A60
<b>FTTH</b>	B19, F12
<b>Faceplates</b>	See Wallplates

TERM	PAGE
<b>Faceplates, Modular Furniture</b>	A53-A54
<b>Fan-Out Kits</b>	B63, B72, X12
Termination Instructions	X12
<b>FastCAM®</b>	
Connectors	B60
Termination Instructions	X10
<b>Fast-Cure®</b>	
Connectors	B61
Termination Instructions	X11
<b>Fiber</b>	
50/125µm LOMM (OM3/OM4)	See LOMM
50/ & 62.5/125µm MM (OM1/OM2)	See MM
SM (OS1/OS2)	See SM
Adapter Plates	B9-B10, B14, B21-B22, B35-B36
Adapters	B64, B66
Blade Replicators	B42
Brackets	B44
Cable Assemblies	See Cable Assemblies, Fiber
Cleavers	B69-B71
Connectors	See Connectors, Fiber
Consumables	B72
Duct (Fiber Raceway System)	C5-C12
Enclosures	See Enclosures
Fan-Out Kits	B63, B72, X12
Harnesses	B51-53
LightSpace®	See LightSpace
MTP® Brackets	B44
MTP Cassettes	B23-24
Opt-X®	See Opt-X
Opt-X Ultra®	See Opt-X Ultra
Panels	B20, B29, B40, E5
Patch Cords	B54-B58, E6
Pigtails	B55, B57-B58
Secure Keyed LC	B50, B53, B58, B62, E6
Splice Modules	B25
Splice Trays, Sleeves & Holders	B25, B37-B38
Tools	B62-B72

TERM	PAGE
Trunk Cables	B5, B46-B50
<b>Fiber Raceway System (FRS)</b>	C5-C12
<b>Fire-Rated Back Box</b>	F27-F28
<b>Floor Box Assemblies</b>	A51
<b>Floor Connectors</b>	A51
<b>Flush-Mount Enclosures</b>	B18, B39-B40
<b>FLX Series PDUs</b>	D3-D8
<b>Furniture Brackets &amp; Faceplates</b>	A53-A54
<b>GigaMax® CAT 5e</b>	
Cable Assemblies	See Cable Assemblies, Copper
Connectors	A6, A38, A40
Cross Connect	A24
Patch Panels	See Patch Panels, Copper
System Overview	A6
<b>Harnesses</b>	B44, B51-B53
<b>HDF3168 Distribution System</b>	B7-10
<b>HDMI® Connectors &amp; Inserts</b>	A42
<b>High-Density Cassette System (e2XHD)</b>	A8, A18, B30
<b>Home Audio</b>	See Audio, Home
<b>Industrial Connectivity (DuraPort®)</b>	A55-A56
<b>Inserts, Wallplate</b>	
A/V	A42, A46
Decora®	A42, A44, A46, A51
Duplex Outlet-Style	A51
Excella® 86 mm x 86 mm	A57
Other 86 mm x 86 mm	A58
<b>Intact™ Intelligent Port Management System</b>	E2-E6
<b>J-Box Kit</b>	F14
<b>Jacks (Connectors)</b>	
A/V	See Connectors, A/V
Copper	See Connectors, Copper
Floor	A51
<b>JBL® Home Audio</b>	F27, F29
<b>Labeling Solutions</b>	
e2XHD	A18, B29
Patch Panels	A20, A68

TERM	PAGE
Work Area	A68
<b>Leviton Architectural Edition®</b>	F27, F29
<b>LightSpace®</b>	
Accessories	B38
Adapter Plates	B35-B36
Rack-Mount Enclosures	B32
Wall-Mount Enclosures	B33-B34
<b>LOMM Fiber (Laser-Optimized Multimode), 10G</b>	
Adapter Plates	B9-10, B14, B21-B22
Cable Assemblies	See Cable Assemblies, Fiber
Connectors	B60-B62
MTP® Cassettes	B9-B10, B14, B23, B30
Splice Modules	B25
<b>LOMM Fiber (Laser-Optimized Multimode), 40/100G</b>	
Cable Assemblies	See Cable Assemblies, Fiber
MTP Cassettes	B9-B10, B14, B24, B30
Opt-X® Unity	B6, B47-B48
<b>Low Smoke Zero Halogen</b>	A28-A29, A31-A32
<b>Make-to-Order</b>	
Brackets, Fiber	B44
Cable Assemblies, Copper	A28-A32, A34
Cable Assemblies, Fiber	See Cable Assemblies, Fiber
Enclosures, Fiber	See Enclosures
Modules, MTP (Cassettes)	B23-B24
Panels, Fiber	B40
PDUs, FLX Series	D3-D8
Secure Keyed LC System	B46, B50, B53, B58, B62
Secure RJ System	A33-A34, E5-E6
<b>Metered Series PDUs</b>	D9-D10
<b>MM Fiber (Multimode), Laser-Optimized</b>	See LOMM
<b>MM Fiber (Multimode), Standard</b>	
Adapter Plates	B9-B10, B14, B21-B22, B35
Cable Assemblies	See Cable Assemblies, Fiber
Connectors	B60-B62
MTP Cassettes	B9-B14

TERM	PAGE
System Overview	B3-B4
<b>Mobile Device Station</b>	F31-F32
<b>Modules, Voice, &amp; Data</b>	F19
<b>Mounting Plates, Structured Media</b>	F15-F16
<b>MTO</b>	See Make-to-Order
<b>MTP Brackets</b>	B44
<b>MTP Modules (Cassettes)</b>	See Cassettes, MTP (Modules)
<b>Multimedia Outlet System (MOS)</b>	
Copper & A/V	A10, A45-A46
Fiber	B65-B66
<b>NIDS (Network Interface Devices)</b>	B34
<b>Opt-X</b>	
Accessories	B26
Adapter Plates	B21-B22
Enclosures, Rack-Mount	B17-B18
Enclosures, Wall-Mount	B19
<b>Opt-X HD</b>	
Accessories	B13
Adapter Plates	B14
Cassettes	B14
Enclosures	B12-B13
<b>Opt-X Ultra®</b>	
Accessories	B26
Enclosures, Rack Mount	B16
<b>Opt-X Unity</b>	B6, B24, B47-B48, B51, B54
<b>Overhead Infrastructure Platform</b>	C3-C4
<b>P1000 Series PDUs</b>	D11-D12
<b>Palm Tool</b>	A66
<b>Patch Blocks</b>	A15
<b>Patch Cords</b>	See Cable Assemblies
<b>Patch Panel Labeling Solutions</b>	A20, A68
<b>Patch Panels, Copper</b>	
110-Style/Universal	A13-A14, A16-A17, A20
Angled	A16
Blank	A14, C15, C17
C1 Ultra Composite	A14

TERM	PAGE
Category 5e	A13-A17
Category 6	A13-A17
Category 6A	A13-A17
e2XHD Patching System	A8, A18
Flat	A13-A15
High-Density	A18
Intact™ Intelligent	E5
Patch Block	A13, A15
QuickPort®	A14-A17
Recessed Angled	A17
Recessed Flat	A17
Selection Guide	A12
Shielded	A15-A16
Transitional Covers	C17
Twist & Mount (MDU)	F17
VertiGO®	A19
Voice Grade	A20
<b>Patch Panels, Fiber</b>	
e2XHD Patching System	B27-B30
High-Density Flush-Mount	B39-B40
Intact Intelligent	E5
Opt-X 500i	B18
VertiGO	B20
<b>Pigtails</b>	B55, B57-B58
<b>Power Distribution Units (PDUs)</b>	
4500 Series	D14
5500-5505 Series	D13
FLX Series	D3-D8
Metered Series	D9-D10
P1000 Series	D11-D12
Switched Series	D9-D10
<b>Power Supplies, Structured Media®</b>	F6, F14
<b>Pre-terminated Solutions</b>	
Cable Assemblies, Copper	A27, A30-A32
Cable Assemblies, Fiber	B45-B58
Fiber Overview	B5-B6
MTP® Cassettes	B9-B10, B13-B14, B23-B24, B27-B30

TERM	PAGE
<b>QuickPack®</b>	A38
<b>QuickPort</b>	
A/V Connectors & Adapters	See Connectors, A/V
Blank Inserts	A42
Copper Connectors (Jacks)	See Connectors, Copper
Decora® Wallplates & Inserts	A42, A44, A51
Excella® Wallplates & Inserts	A57
Fiber Adapters	B64, B66
Furniture Faceplates	A53, A54
Patch Panels	A14-A17
Surface-Mount Boxes	A54
Wallplates, Plastic	A48, A50, F24
Wallplates, Stainless Steel	A49, F24
<b>Raceway (Fiber Raceway System)</b>	C5-C12
<b>Rack-Mount Enclosures</b>	See Enclosures, Rack-Mount
<b>RCA Connectors</b>	A43-A44
<b>Receptacles, Recessed (MDU)</b>	F31-F32
<b>Recessed Entertainment Box (MDU)</b>	F31-F32
<b>Replicator® Enclosures</b>	B43
<b>Routers &amp; Switches (MDU)</b>	F13
<b>S-Video Connectors &amp; Adapters</b>	A42, F22
<b>Secure Keyed LC System</b>	B50, B53, B58, B62, E6
<b>Secure RJ System</b>	A33-A34, E5-E6
<b>Shielded Connectivity</b>	
Cable Assemblies	A28-A29
Connectors	A7, A40
Patch Panels	A15-16
System Overview	A7
Termination Instructions	X8
<b>SlimLine Patch Cords</b>	A28-A29
<b>SM Fiber (Single-Mode)</b>	
Adapter Plates	B9, B14, B21-B22, B35-B36
Cable Assemblies	See Cable Assemblies, Fiber
Connectors	B60-B62
MTP Cassettes	B9-B10, B14, B23, B30
Splice Modules	B25
System Overview	B3-B4

TERM	PAGE
Speakers (MDU)	F27-F29
Splice Trays, Holders, & Sleeves	B25, B37-B38
Splitters	F6, F21
Stainless-Steel Wallplates	See Wallplates, Stainless Steel
Standards	X15-16
<b>Structured Media®</b>	
Brackets	F10, F15-F16
Cabling Panels	F17-F18
Enclosures	F5-F12
Expansion Boards	F19-F20
Modules	F19
Mounting Plates	F15-F16
Patch Panels	F17-F18
Power Supplies	F6, F14
Video Modules	F21
<b>Surface-Mount Boxes</b>	
Back Boxes	A53-54
QuickPort®	A53-54
Telephone	A61
<b>Switched Series PDUs</b>	D9-D10
<b>Switches &amp; Routers (MDU)</b>	F13
<b>Telephone Input Distribution Panel (TIDP)</b>	F17
<b>Telephone Jacks, Inserts &amp; Wallplates</b>	A59-A62
<b>Termination Instructions</b>	
Copper	X7-X9
Fiber	X10-X12
<b>Tools</b>	
Copper	A65-A68
Fiber	B67-B72
Fiber Raceway System	C12
MDU	F16
<b>Transitional Covers, Rack-Mount</b>	C17
<b>Trunk Cables</b>	See Cable Assemblies
<b>Twist &amp; Mount Patch Panels</b>	F17
<b>Ultra High-Flex Patch Cords</b>	F15
<b>USB Connector</b>	A42
<b>USB Receptacle</b>	F31-F32

TERM	PAGE
<b>VELCRO® Brand Fasteners</b>	C19-C20
<b>Versi-Duct® Cable Management</b>	C13-C14
<b>VertiGO® Patch Panels</b>	
Copper	A19
Fiber	B20
<b>VGA Connectors</b>	A46
<b>Video Connectors</b>	See Connectors, A/V
<b>Video Modules, Structured Media</b>	F21
<b>Video Splitters</b>	F6, F21
<b>Video Wallplates</b>	A59-A60
<b>Visual Fault Locator</b>	B60, B68, B71
<b>Voice-Grade Connectivity</b>	A20, A59-A62, F17-F19, F22
<b>Wall-Mount Enclosures</b>	See Enclosures, Wall-Mount
<b>Wall-Phone Jacks, Inserts, &amp; Wallplates</b>	A49, A59-A62
<b>Wallplate Inserts</b>	See Inserts, Wallplate
<b>Wallplates (Faceplates)</b>	
Angled	A49-A50, A57
A/V (MDU)	E23-E25, F23-F25
Decora®	A63
Duplex	A64
Excella®	A57
Midway	A50, A59, A63-A64
Renu®	A52
Round Opening	A64
Shielded Connectors	A49-A50
Standard	A48-A49, A59
Stainless Steel	A49, A55-A56, A62-A64, F24
Telephone	A49, A59-A60, A62
Video	A59-A60
<b>Wireless</b>	
Access Points	C22
Enclosures	C22
<b>Wiring Standards</b>	X4
<b>Zero-U Patch Panels</b>	
Copper	A19
Fiber	B20
<b>Zone Enclosures</b>	C21

# INDEX | Part Number Index

PART NO.	PAGE	PART NO.	PAGE	PART NO.	PAGE
100-DUTAZ-MLS	AA3	154-UTP5Z-MWB	AA8	300-UTP6Z-MLB	AA5
100-FTP6M-MLS	AA7	155-UTP5Z-SWS	AA8	301-UTP6M-MSB	AA6
100-FTPAR-MLS	AA4	160-FTP6Z-5WS	AA7	301-UTP6Z-MSB	AA5
100-FTP6Z-MLS	AA4	160-FTP6Z-5WS	AA4	900-50LAZ-242	AA10
100-UTP5N-MLB	AA8	160-SFSAZ-5WS	AA4	900-SMDRZ-081	AA9
100-UTP5Z-MLB	AA8	160-SFTAZ-5WS	AA4	900-SMLAZ-482	AA10
100-UTP6M-MLB	AA6	180-FTP5Z-5WS	AA7	900-SMLRZ-041	AA10
100-UTP6N-MLB	AA6	180-FTP6Z-5WS	AA7	901-SMLRZ-081	AA10
100-UTP6Z-MLB	AA5	180-SFTAZ-5WS	AA4	9D5-SMDRZ-021	AA9
100-UTPAR-MLS	AA3	180-UFPAZ-5WS	AA4	00688-***	F32
101-DUTAZ-MSS	AA3	180-UTP6N-MLB	AA6	00689-***	F32
101-FTP6Z-MSS	AA7	180-UTP6Z-5WS	AA5	00690-***	F32
101-FTPAR-MSS	AA4	181-SFTAZ-5SS	AA4	00PJ7-***	A64
101-FTP6Z-MSS	AA4	181-UTP6N-MSB	AA6	00PJ8-***	A64
101-UTP5N-MSB	AA8	181-UTP6Z-MSB	AA5	05261-0CH	F32
101-UTP5Z-MSB	AA8	185-UTC6Z-MWB	AA5	05361-0CH	F32
101-UTP6M-MSB	AA6	186-UTC6Z-5WS	AA5	0PJ82-***	A64
101-UTP6N-MSB	AA6	187-UTC6Z-MSB	AA5	3005C-C00	F26
101-UTP6Z-MSB	AA5	188-UTC6Z-MLB	AA5	40050-***	A26
101-UTPAR-MSS	AA3	1DA-SMLAZ-042	AA10	40054-***	A26
102-DUTAZ-MWS	AA3	1DC-SMLAZ-082	AA10	40066-***	A26
102-FTP6Z-5WS	AA4	203-UTCAZ-MLS	AA3	40067-0BC	A26
102-UTP5M-MLS	AA8	205-UTCAZ-MSS	AA3	40070-MDP	A67
102-UTP5N-MLS	AA8	290-UTP5M-MLB	AA8	40072-***	A26
102-UTP5Z-MLS	AA8	290-UTP5R-MLB	AA8	4007C-C00	F26
102-UTP6N-MLS	AA6	291-UTP5M-MSB	AA8	40089-00D	A15, A26
102-UTP6Z-MLS	AA5	291-UTP5R-MWB	AA8	40144-***	A60
103-UTP5M-MSS	AA8	292-UTP5R-MSB	AA8	40149-***	A60
103-UTP5N-MSS	AA8	296-UTP6M-MLB	AA6	40159-***	A60
103-UTP5Z-MSS	AA8	297-UTP6M-MSB	AA6	40201-00I	A61
103-UTP6N-MSS	AA6	2D1-50DRR-061	AA9	40214-***	A62
103-UTP6Z-MSS	AA5	2D1-50DRZ-041	AA9	40223-00S	A62
104-UTP5M-MWB	AA8	2D1-50LAZ-062	AA10	40226-00S	A62
104-UTP6M-MYB	AA6	2D1-50LRZ-061	AA10	40238-***	A59
104-UTP6R-MLB	AA6	2D1-5LDRR-061	AA9	40244-***	A59
104-UTP6Z-MWB	AA5	2D1-5LDRZ-041	AA9	40249-***	A59
105-UTP5M-MRB	AA8	2D1-5LLAZ-062	AA10	40253-***	A62
105-UTP6M-MWB	AA6	2D1-5LLRZ-061	AA10	40257-***	A62
105-UTP6R-MSB	AA6	2D1-SMDRR-061	AA9	40258-***	A59
106-UTP6M-MRB	AA6	2D1-SMLAZ-062	AA10	40259-***	A59
107-UTP5M-MYB	AA8	2D1-SMLRZ-061	AA10	40278-***	A61
108-UTP6M-MGB	AA6	2D2-50DRR-121	AA9	40539-***	A59
110-EUT5P-MLB	AA8	2D2-50DRZ-061	AA9	40644-***	A60
110-EUT5R-MLB	AA8	2D2-50LAZ-122	AA10	40649-***	A60
110-EUT6P-MLB	AA5	2D2-50LRZ-121	AA10	40659-***	A60
110-EUT6R-MLB	AA6	2D2-5LDRR-121	AA9	40681-***	A60
110-EUTAP-MLS	AA3	2D2-5LDRZ-121	AA9	40682-***	A60
110-EUTAR-MLS	AA3	2D2-5LLAZ-122	AA10	40734-***	A42, F22
111-EUT6P-MSB	AA5	2D2-5LLRZ-121	AA10	40735-***	A43, F22
111-EUT6P-MSS	AA5	2D2-SMDRR-121	AA9	40782-***	F22
111-EUT6R-MSB	AA6	2D2-SMLAZ-122	AA10	40812-RTK	F16
111-UTP5R-MSB	AA8	2D2-SMLRZ-121	AA10	40830-***	A43, F22
111-EUTAP-MSS	AA3	2D3-50DRR-241	AA9	40831-***	A43, F22
111-EUTAR-MSS	AA3	2D3-50DRZ-121	AA9	40832-***	A42, F22
112-EUT5P-MWB	AA8	2D3-5LDRR-241	AA9	40833-***	A42, F22
112-EUT5R-MWB	AA8	2D3-5LDRZ-241	AA9	40834-***	A42, F22
112-EUT6P-MWB	AA5	2D3-SMLAZ-242	AA10	40835-***	A42, F22
112-EUT6R-MWB	AA6	2D4-5LDRZ-061	AA9	40837-***	A42, F22
112-EUTAP-MWS	AA3	2D7-SMDRZ-061	AA9	40839-***	A42, F22
112-EUTAR-MWS	AA3	2D8-SMDRZ-121	AA9	40951-***	F32
114-UTP6R-MSB	AA6	2D9-SMDRZ-241	AA9	40952-***	F32
115-UTP6R-MLB	AA6	300-UTP6M-MLB	AA6	40981-***	A60

PART NO.	PAGE	PART NO.	PAGE	PART NO.	PAGE
40982-***	A60	41NB6-1F4	A22	49257-***	A20, A68
40985-***	A44, F22	42080-***	A48, A50	49258-***	C15
40988-000	A67	42081-***	A50, F24	4925C-***	C15
40989-ACT	F16	42400-8FG	F15	49260-***	C18
40989-CPT	A67, F16	42777-***	A54	49261-BKT	C18
41010-SPW	C20	43080-***	A49, A68, F24	49262-HR1	C18
41020-SPR	C20	43081-***	A49, F24	49265-***	C14
41030-SMJ	A54	43105-***	C19, F16	49280-***	A19, B20
41054-IDD	A61	43108-***	C19	492RU-***	C14
41080-***	A48, A50, A68, F24	43112-***	C19	49300-SM*	C15
41081-***	A50, F24	43115-***	C19	49400-FHB	C18
41084-***	A42-43, B64, F22	44115-***	C19	4940L-***	C14
41085-***	B64	4515-***	D14	49553-***	A66, F16
41087-***	A51	4520-***	D14	49560-TTS	A67
41089-***	A54	45224-RCS	C20	49561-SSP	A67
4108W-***	A49, F24	4625A-***	A61	49562-TSK	A67
41091-***	A50	46700-SLG	C20	49605-30W	F11
410L2-***	A24	47112-***	F32	49660-00P	F16
41100-HLD	A22, A24, A68	47600-QPB	F15	49800-***	B63, B70, B72
41106-***	A39, F22	47603-***	F17-F20	4980L-***	C14
41108-***	A39, F22	47604-***	F8	49886-***	A66, B61, B71-B72
41150-***	C15	47605-***	F8, F10, F14, F19	49886-VFL	B71
41188-SM2	C16	47606-***	F18	49887-***	B63
41225-SAP	C20	47609-***	F19, F20	49910-***	A54
41290-***	A46, B65	47611-***	F13, F19	49990-***	B61
41291-***	A46, B66	47612-***	F10, F15, F16	49991-***	B60
41292-***	A46, B66	47612-28B	F10	4999K-***	B62
41293-***	A46, B66	47612-42B	F10	4MKIT-F24	E5
41294-***	A46, B66	47613-***	F16	4MSYS-BKT	E5
41295-***	A46, B66	47615-NYL	F16	4MSYS-IDH	E5
41296-***	A46, B65	47615-PTT	A66	4MSYS-IDM	E5
41600-00I	A26	47616-DSF	F19, F20	4S089-***	A54
41620-00I	A26	47617-***	F32	4S115-75E	C19
41638-***	A60	47689-00B	F19	4S255-***	A15
41641-***	A51, F25	47689-00P	A15	4S256-***	A16
41642-***	A51, F25	47690-***	F21	4W006-AMB	C16
41643-***	A51, F25	47693-***	F21	4W254-***	C15, C17
41644-***	A51, F25	476TL-T12	F17	4W256-***	A17
41646-***	A51, F25	476TM-***	F17	5020C-***	F26
41647-***	A42, F25	47FTH-***	F12	50DCL-***	B56
41648-***	A42, F25	48211-***	F30	50DLC-***	B56
41649-***	A46, B65	48212-***	F14	50DSC-***	B56
41650-***	A51	48605-***	F11	50DST-***	B56
41652-***	A51	48900-***	C20	50PLC-KIT	B57
41658-***	A60	49005-***	C16	50PLC-M03	B57
41880-***	A25	49006-AMB	C16	50PSC-KIT	B57
41A10-HCM	A24	49012-***	A20	50PSC-M03	B57
41AB2-***	A24	49013-***	A20	50PST-KIT	B57
41AB6-***	A22	49014-***	A20	50PST-M03	B57
41AW1-***	A24	49018-***	A20	51084-***	A68, F25
41AW2-***	A24	49103-IDC	A24	542LL-A03M	B54
41D10-HCM	A24	49104-***	A24	542LL-B03M	B54
41D1R-HCM	A24	49105-IDC	A24	548MM-A03M	B54
41D6A-1F4	A22	491RU-***	C14	548MM-B03M	B54
41DBR-***	A24	49200-00M	A26	54DLC-M**	B56
41DR2-***	A24	49222-***	A54	54DCL-M**	B56
41DR6-***	A22	49251-***	C18	54PLC-KIT	B57
41DW1-***	A24	49252-***	C15	54PLC-M03	B57
41DW2-100	A24	49253-***	C15	5500-***	D13
41LBL-***	A22, A24, A68	49254-***	C15, C17	5505-190	D13
41MB2-***	A25	49255-***	A15, A17, E5	59265-5DC	C14
41NB2-***	A24	49256-***	A16	5C000-RPL	B26

# INDEX | Part Number Index

PART NO.	PAGE	PART NO.	PAGE	PART NO.	PAGE
5CMTL-RPL	B26	5W120-00N	B19	80716-***	A64
5D000-***	B26	5W170-00N	B19	80781-***	A59
5D460-***	A29	5W310-00N	B19	80782-***	A59
5F100-***	B22, F15	5W320-00N	B19	84003-040	A64
5FUHD-***	B10, B14	5W370-00N	B19	84004-040	A64
5G108-***	A38, A66, F22	5W597-U48	A17	84014-040	A64
5G110-***	A38, A66	5W710-00N	B19	84016-040	A64
5G240-***	A24	5W720-00N	B19	84025-040	A64
5G270-***	A15	5W770-00N	B19	84401-040	A63, F25
5G34A-***	A24	5Z460-***	A29	84409-040	A63, F25
5G34B-***	A24	6110G-R*6	A37	85003-000	A64
5G460-***	A29	61110-***	A38, A66	85004-000	A64
5G596-***	A13, A17	6210G-***	A28	85014-000	A64
5G597-***	A16	62240-***	A22	85016-000	A64
5HHOM-***	F15	6234B-***	A22	85025-000	A64
5L000-KAL	B26	62460-***	A29	86003-000	A64
5L000-LOK	B19, F8, F10	62DCL-***	B56	86004-000	A64
5L2LL-A03M	B54	62DCT-***	B56	86014-000	A64
5L2LL-B03M	B54	62DLC-***	B56	86016-000	A64
5L4JJ-B03M	B54	62DSC-***	B56	86025-000	A64
5L8MM-A03M	B54	62DST-***	B56	87003-000	A64
5L8MM-B03M	B54	62PLC-KIT	B57	87014-000	A64
5LDLC-***	B56	62PLC-M03	B57	87016-000	A64
5LDCL-***	B56	62PSC-KIT	B57	87025-000	A64
5LDSC-***	B56	62PSC-M03	B57	88003-000	A64
5LPLC-KIT	B57	62PST-KIT	B57	88004-000	A64
5LPLC-M03	B57	62PST-M03	B57	88014-000	A64
5LPSC-KIT	B57	69104-IDC	A22	88016-000	A64
5LPSC-M03	B57	6910G-***	A15	88025-000	A64
5LPST-M03	B57	69270-***	A15	89265-***	C13
5PCBR-*BT	B26	69585-IDL	A20, A68	8980L-***	C13
5R100-14R	B26	69586-***	A13, A17	8C80L-***	C13
5R1RU-023	B26	69587-***	A16	AB100-00*	A39
5R1UE-OPX	B18	6A10G-R*6	A37	AB200-00*	A39
5R1UH-S03	B16, E5	6A586-U**	A13	AB300-00*	A39
5R1UH-S08	B13	6A587-***	A16	AEBC6-000	F27, F28
5R1UL-CMT	B26, B40	6AS10-***	A28	AEC65-000	F27
5R1UL-F03	B18	6ASHD-S6A	A40	AEC80-000	F27
5R1UM-S08	B13	6AZ10-***	A28	AEC65-VCE	F29
5R1UM-*03	B17	6D460-***	A29	AEH50-***	F29
5R1UR-TRY	B13	6H460-***	A29	AEHTK-000	F32
5R2UH-S06	B16, E5	6S180-SH6	A40	AEI55-000	F29
5R2UH-S16	B13	6S460-***S	A29	AEI65-000	F27
5R2UL-CMT	B26	6W587-U48	A17	AEI80-000	F27
5R2UL-F06	B18	6Z460-***	A29	AEM65-000	F27
5R2UM-S16	B13	78003-000	A64	AEMRK-000	F32
5R2UM-*06	B17	78014-000	A64	AEN24-000	F27
5R2UR-TRY	B13	78016-000	A64	AEPHK-***	F29
5R3UE-OPX	B18	78025-000	A64	AEP16-KIT	F27
5R3UL-F12	B18	78804-000	A64	AEP18-KIT	F27
5R3UM-***	B17	80301-***	A63, F25	AEPIS-KIT	F29
5R4UH-S12	B16	80309-***	A63, F25	AESS5-***	F29
5R4UM-***	B17	80401-***	A63, F25	AESUB-012	F29
5RCMP-KIT	B13, B26, B29	80409-***	A63, F25	APL12-***	B36
5RCMP-KT2	B13, B26, B29	80414-***	A51	APLW6-***	B36
5RCMR-KIT	B13, B26, B29	80503-***	A64	APLW8-***	B36
5RKIT-OM3	E5	80504-***	A64	APPLC-S03	B57
5RKIT-OS2	E5	80516-***	A64	APPSC-S03	B57
5S180-SH5	A40	80601-***	A63, F25	APSSC-***	B57
5S460-***S	A29	80609-***	A63, F25	BL000-00W	A57
5T000-00T	B25, B37, B38	80703-***	A64	BL186-***	A57
5W110-00N	B19	80704-***	A64	BLWP1-***	A57



PART NO.	PAGE	PART NO.	PAGE	PART NO.	PAGE
C022*-***	F25	FB352-10L	D8	FM324-10L	D8
C1253-2CM	A14, C15, C17	FB353-10L	D7	FM330-10L	D7
C1255-H48	A14	FB354-10L	D8	FM331-10L	D8
C1586-U48	A14	FB355-10L	D7	FM337-10L	D8
C1686-U48	A14	FB356-10L	D8	FM346-10L	D8
C5914-000	F16	FB360-10L	D8	FM347-10L	D7
CH149-***	F26	FB361-10L	D8	FM348-10L	D8
CH159-***	F26	FB364-10L	D8	FM352-10L	D8
CH181-***	F26	FB367-10L	D8	FM353-10L	D7
CPC12-STD	B33	FB371-10L	D8	FM354-10L	D8
CPC24-STD	B33	FB373-10L	D7	FM355-10L	D7
CPC48-STD	B33	FB374-10L	D8	FM356-10L	D8
CPCSR-***	B38	FB375-10L	D8	FM360-10L	D8
CPGRD-KIT	B38	FB382-10L	D7	FM361-10L	D8
CPLOK-KIT	B38	FB386-10L	D8	FM364-10L	D8
CPS12-STD	B33	FB387-10L	D8	FM367-10L	D8
CPS24-STD	B33	FB388-10L	D8	FM371-10L	D8
CPS48-STD	B33	FB389-10L	D7	FM373-10L	D7
D6700-00E	A56	FB390-10L	D8	FM374-10L	D8
D6701-00E	A56	FB391-10L	D8	FM375-10L	D8
D6706-00E	A56	FB403-10L	D8	FM376-10L	D7
D670K-***	A56	FB406-10L	D7	FM377-10L	D8
D6710-***	A56	FB407-10L	D8	FM378-10L	D8
D6720-***	A56	FB410-10L	D7	FM379-10L	D7
D6721-***	A56	FB411-10L	D7	FM380-10L	D8
D675E-00E	A56	FB412-10L	D8	FM381-10L	D8
DP03U-STD	B32	FB413-10L	D7	FM382-10L	D7
DP04U-STD	B32	FB424-10L	D8	FM386-10L	D8
DP06U-STD	B32	FB426-10L	D8	FM387-10L	D8
DPC6U-033	B32	FB428-10L	D8	FM388-10L	D8
DPC8U-STD	B32	FB429-10L	D8	FM389-10L	D7
DPC12-066	B32	FB431-10L	D7	FM390-10L	D8
DPCMP-UNV	B38	FB432-10L	D8	FM391-10L	D8
DPGRD-KIT	B26, B38	FB433-10L	D8	FM403-10L	D8
DPLOK-KIT	B38	FB434-10L	D8	FM406-10L	D7
DPS3U-STD	B32	FB445-10L	D8	FM407-10L	D8
DPS4U-STD	B32	FB446-10L	D7	FM410-10L	D7
DPS6U-STD	B32	FB447-10L	D8	FM411-10L	D7
DUSTK-CAP	B62	FB448-10L	D8	FM412-10L	D8
E2X**_***	A18, B29-B30, C16	FB449-10L	D8	FM413-10L	D7
ETRTN-*TL	B62, E6	FB450-10L	D7	FM424-10L	D8
F3168-***	B10	FB451-10L	D8	FM426-10L	D8
FB106-***	B44	FB452-10L	D8	FM428-10L	D8
FB109-***	B44	FB453-10L	D8	FM429-10L	D8
FB110-VST	B44	FM-*012BACO*	B23	FM431-10L	D7
FB112-***	B44	FM-*024CACA*	B23	FM432-10L	D8
FB204-10L	D7	FM -*024CDCOB*	B23, B24	FM433-10L	D8
FB206-10L	D7	FM-*012CACO+	B23	FM434-10L	D8
FB207-10L	D7	FM -*024NCCOB*	B24	FM445-10L	D8
FB210-10L	D7	FM -*024NDCOB*	B24	FM446-10L	D7
FB310-10L	D7	FM -*048NDCOB*	B24	FM447-10L	D8
FB311-10L	D8	FM105-10L	D7	FM448-10L	D8
FB313-10L	D7	FM106-10S	D7	FM449-10L	D8
FB315-10L	D8	FM107-10L	D7	FM450-10L	D7
FB324-10L	D8	FM204-10L	D7	FM451-10L	D8
FB330-10L	D7	FM206-10L	D7	FM452-10L	D8
FB331-10L	D8	FM207-10L	D7	FM453-10L	D8
FB337-10L	D8	FM210-10L	D7	FME2XHD	B44
FB433-10L	D8	FM310-10L	D7	FSHAT-F06	B25, B37
FB346-10L	D8	FM311-10L	D8	FSHBF-P12	B25, B37
FB347-10L	D7	FM313-10L	D7	FSHHS-P06	B25, B37
FB348-10L	D8	FM315-10L	D8	FSHHS-P08	B25, B37

# INDEX | Part Number Index

PART NO.	PAGE	PART NO.	PAGE	PART NO.	PAGE
FSHMI-F06	B25, B37	S1LRU-000	C11	SGVSM-00W	F30
FSHMR-F06	B25, B37	S1RMK-000	C11	SGVST-00W	F30
FSHRB-F06	B25, B37	S25RT-02M	C10	SH081-1D1	D10
FSHSL-F06	B25, B37	S2CUT-TOL	C12	SH082-1C2	D10
FSSMI-025	B38	S2DCT-***	C6	SMH00-SMB	C11
FSSMI-040	B38	S2DMB-000	C11	SMTRE-***	C12
FSSMR-025	B38	S2DRP-***	C9	SPLMT-HKT	B25, B37
FSSMR-040	B38	S2END-***	C10	SPLCS-***	B25
FSSRB-Q40	B38	S2FSL-INL	C9	SPSCS-***	B25
FSSSD-040	B38	S2HCR-***	C8	SRAGD-SLT	C6
FSSSD-060	B38	S2HEL-***	C8	SRJ6*-***	A34
FSSSL-040	B38	S2HTE-***	C8	SRJET-00*	A34, E6
FSSSL-060	B38	S2JNR-SLT	C8	SRJPB-00*	A34
FTH00-00W	F12	S2TRM-TRM	C9	SSLOT-***	C12
LF145-01W	A58	S2VEL-***	C8	SV161-1D1	D10
LI137-***	A58	S2VTE-***	C8	SV162-1C2	D10
LI145-***	A58	S4ADP-***	C10	SWDCT-***	C6
LI150-***	A58	S4CUT-TOL	C12	SWDMB-000	C11
MH101-1D1	D10	S4DCT-***	C6	SWEND-CSL	C10
MH122-1C2	D10	S4DMB-000	C11	SWHCR-***	C8
MLCPB-*LG	E6	S4DRP-DRP	C9	SWHEL-***	C8
MRJPB-00*	E6	S4END-***	C10	SWHTE-***	C8
MV121-1B1	D10	S4EXT-KIT	C11	SWJNR-***	C8
MV241-1D1	D10	S4FSL-***	C9	SWRDR-***	C10
MV242-1C2	D10	S4HCR-***	C8	SWRMK-000	C11
N3500-STD	B34	S4HEL-***	C8	SWSUS-***	C11
N502H-STD	B34	S4HTE-***	C8	SWVEL-***	C8
N5300-STD	B34	S4JNR-***	C8	SWVTE-***	C8
OIP*_*-***	C3-C4	S4LRU-000	C11	T47BF-P06	B37, B38
P1020-12S	D12	S4MNT-KIT	C11	T47HS-P06	B25, B37, B38
P1021-12S	D12	S4RDR-***	C10	T4LBF-P06	B25, B37, B38
P1022-12L	D12	S4RMK-000	C11	T4LBF-P12	B37, B38
P1023-12L	D12	S4SUS-KIT	C11	T4LHS-F06	B37, B38
P1024-12L	D12	S4TRM-TRM	C9	T4LHS-F12	B37, B38
P1025-12L	D12	S4VEL-***	C8	T4LHS-P06	B37, B38
P1040-10S	D12	S4VTE-***	C8	T4LHS-P12	B37, B38
P1041-10S	D12	S50RT-***	C10	T5630-00W	F32
P1042-10L	D12	S50ST-350	C10	T5LBF-P06	B37, B38
P1043-10S	D12	S5STC-350	C10	T5LBF-P12	B37, B38
P1044-10L	D12	S8ADP-***	C10	T5LHS-B12	B37, B38
P1045-10L	D12	S8DCT-***	C6	T5LHS-F06	B37, B38
P1046-10L	D12	S8DMB-000	C11	T5LHS-F12	B37, B38
P1047-10L	D12	S8END-***	C10	T5LHS-P06	B37, B38
P1070-10S	D12	S8EXT-KIT	C11	T5PLS-12F	B25
P1071-10S	D12	S8FSL-***	C9	T5PLS-24F	B10, B25
P1072-10L	D12	S8HCR-***	C8	T6XRB-40Q	B37, B38
P1073-10S	D12	S8HEL-***	C8	TCORD-010	D10
P1074-10L	D12	S8HTE-***	C8	UPDCL-***	B57
PCI65-KIT	F28	S8JNR-***	C8	UPDCT-***	B57
PCORD-***	D10	S8LRU-000	C11	UPDLC-***	B57
PDURK-***	D5, D11	S8MNT-KIT	C11	UPDSC-***	B57
PJ26-***	A63, F25	S8RDR-***	C10	UPDST-***	B57
PJ262-***	A63, F25	S8RMK-000	C11	UPPLC-KIT	B57
PPRTN-*LG	B62	S8SUS-KIT	C11	UPPLC-S03	B57
RE640-***	A52, F23	S8VEL-***	C8	UPPSC-KIT	B57
REWM1-STS	A52	S8VTE-***	C8	UPPSC-S03	B57
REWM2-STS	A52	SGAMP-000	F30	UPPST-S03	B57
REWP1-***	A52, F23	SGC65-***	F28	VERPB-019	B42
REWP2-***	A52, F23	SGI65-***	F28	W1000-***	C22
REWP3-***	A52, F23	SGO99-00W	F28	Z1000-***	C21
REWP4-***	A52, F23	SGO99-GRL	F28		
RPL-*****PLC3	B42	SGVCK-***	F30		

The following are trademarks of Leviton Manufacturing Company, Inc.:

AutoSurge®	eXtreme®	Intact™	QuickPack®	Structured Media®
Cheetah Speed System®	ez-Learn™	Leviton Architectural Edition®	QuickPort®	Thread-Lock®
Cone of Silence®	FastCAM®	LightSpace®	Renu®	Versa-Cleave®
Decora®	Fast-Cure®	Opt-X®	Replicator®	Versi-Duct®
DuraPort®	GigaMax®	Opt-X Ultra®	ROii®	VertiGO®
Excella®	Home 5e®		Spec-Grade™	

For Leviton warranty information, please visit [leviton.com/warranties](http://leviton.com/warranties).

Other trademarks used in this catalog are registered as follows:

Aironet® is a registered trademark of Cisco Systems, Inc.

AirPort Express®, iPod®, iPad®, and iPhone® are trademarks of Apple Inc., registered in the U.S. and other countries.

Allsteel® is a registered trademark of Allsteel, Inc.

Amphenol™ is a trademark of Amphenol Corporation.

BIX® is a registered trademark of Nortel.

Blu-ray™ and Blu-ray Disc™ are trademarks of the Blu-ray Disc Association.

Cisco, the Cisco logo, and Cisco Systems are trademarks or registered trademarks of Cisco Systems, Inc. and/or its affiliates in the United States and certain other countries.

Clipsal® is a registered trademark of Schneider Electric (Australia) Pty Ltd.

D'Gel® is a registered trademark of Illinois Tool Works.

Elliptical Oblate Spheroidal™, PolyPlas™, and Straight-Line Signal Path™ are trademarks of Harman International Industries, Inc.

Ethospace® and Action Office® are registered trademarks of Herman Miller, Inc.

EZ-RJ45® is a registered trademark of SullStar Technologies, Inc.

JBL® is a registered trademarks of Harman International Industries, Inc.

Haworth® is a registered trademark of Haworth, Inc.

HDMI® is a registered trademark of HDMI Licensing, LLC.

JackRapid™ is a trademark of Fluke Networks.

Kevlar® is a registered trademark of DuPont or its affiliates.

Klein Tools® is a registered trademark of Klein Tools, Inc.

Knoll® is a registered trademark of Knoll, Inc.

Krone® is a registered trademark of Krone, Inc.

LGX® is a registered trademark of Furukawa.

MTP® is a registered trademark of US Conec, Ltd.

Series 9000® and Avenir® are registered trademarks of Steelcase, Inc.

Straight-Line™ and Elliptical Oblate Spheroidal™ are trademarks of Harman International Industries, Inc.

SYSTIMAX® and Uniprise® are registered trademarks of CommScope, Inc.

Teknion® is a registered trademark of Teknion Corporation.

VELCRO® is a registered trademark of Velcro Industries B.V.

Westinghouse® is a registered trademark of Westinghouse Corporation.

Wi-Fi® is a registered trademark of Wi-Fi Alliance.

Windows XP® and Visio® are registered trademarks of Microsoft Corporation.

All other trademarks, service marks, and logos used in this catalog are the property of their respective owners.



© Copyright Leviton Manufacturing Co., Inc. 2014. All rights reserved. All unauthorized quotation and reproduction is forbidden except for brief examples used in reviews of this work by periodical publications where the source of information is credited to Leviton, or the reproduction of this material for the purpose of preparing specifications and/or bids in which Leviton products are indicated. To request permission, please contact the Leviton Network Solutions marketing department at +1.425.486.2222.

Information in this catalog is provided as a guide to product selection and is believed to be correct at time of publication. Because Leviton engages in a continuous program of product improvement, data is subject to change without notice.

## TECHNICAL RESOURCES

**Application / Tech Notes**  
[leviton.com/ns/techlibrary](http://leviton.com/ns/techlibrary)

**Detailed Termination Diagrams**  
[leviton.com/ns/techlibrary](http://leviton.com/ns/techlibrary)

**Dimensional Line Art**  
[leviton.com/ns/techlibrary](http://leviton.com/ns/techlibrary)

**Manuals & Guides**  
[leviton.com/ns/techlibrary](http://leviton.com/ns/techlibrary)

**Training Videos**  
[leviton.com/ns/techlibrary](http://leviton.com/ns/techlibrary)

**BIM Objects**  
[leviton.com/bim](http://leviton.com/bim)

**Visio Stencils**  
[leviton.com/visio](http://leviton.com/visio)

## SUPPORT TEAMS

**Technical Support**  
 800.824.3005 \ +1.425.486.2222  
[appeng@leviton.com](mailto:appeng@leviton.com)

**Inside Sales/Customer Service**  
 800.722.2082 \ +1.425.486.2222  
[insidesales@leviton.com](mailto:insidesales@leviton.com)

**Specification Team**  
[leviton.com/specteam](http://leviton.com/specteam)  
[specteam@leviton.com](mailto:specteam@leviton.com)

**Data Center Team**  
[leviton.com/datacenter](http://leviton.com/datacenter)  
[dcteam@leviton.com](mailto:dcteam@leviton.com)

## WEB SUPPORT

**Make to Order (MTO)**  
[leviton.com/configurator](http://leviton.com/configurator)

**Structured Media® Planning Worksheet**  
[leviton.com/homeconfig](http://leviton.com/homeconfig)

**Independent Testing Information**  
[leviton.com/ns/testresults](http://leviton.com/ns/testresults)

**Literature Library**  
[leviton.com/ns/litlibrary](http://leviton.com/ns/litlibrary)

**Live Chat**  
[leviton.com/support](http://leviton.com/support)

**Knowledgebase & Forums**  
[communities.leviton.com](http://communities.leviton.com)

**CrossTalk Newsletter**  
[leviton.com/crosstalk](http://leviton.com/crosstalk)

**Leviton Wired**  
[blog.leviton.com/network-solutions](http://blog.leviton.com/network-solutions)



**Manufactured in the US**  
and Supported by International Offices and Sales  
Locations Across More than 80 Countries

### The Smart Choice for a Better Network

High-performance connectivity backed by the industry's best service and support. We invent the industry's best technologies. We build them to last. And we stand behind every product and every installation - delivering industry-leading performance and unbeatable service and support - throughout the life of your structured cabling system. Add in the peace of mind that comes from working with a stable, century-old supplier, and you get far and away the highest return on investment in the industry.

#### Leviton Network Solutions Division Headquarters

[leviton.com/networksolutions](http://leviton.com/networksolutions) | 2222 - 222nd Street S.E., Bothell, WA 98021 USA

##### Inside Sales

800.722.2082  
[insidesales@leviton.com](mailto:insidesales@leviton.com)

##### International Inside Sales

+1.425.486.2222  
[intl@leviton.com](mailto:intl@leviton.com)

##### Technical Support

800.824.3005 / +1.425.486.2222  
[appeng@leviton.com](mailto:appeng@leviton.com)

#### Leviton Corporate Headquarters

[leviton.com](http://leviton.com) | 201 N. Service Road, Melville, NY 11747 USA

##### Customer Service

800.323.8920 / +1.631.812.6000  
[customerservice@leviton.com](mailto:customerservice@leviton.com)

#### Leviton International Offices

##### Asia / Pacific

+1.631.812.6228  
[infoasean@leviton.com](mailto:infoasean@leviton.com)

##### Colombia

+57.1.743.6045  
[infocolombia@leviton.com](mailto:infocolombia@leviton.com)

##### Mexico

+52.55.5082.1040  
[lsamarketing@leviton.com](mailto:lsamarketing@leviton.com)

##### Canada

+1.514.954.1840  
[pcservice@leviton.com](mailto:pcservice@leviton.com)

##### Europe

+33.6.8869.1380  
[infoeurope@leviton.com](mailto:infoeurope@leviton.com)

##### Middle East & Africa

+971.4.886.4722  
[lmeinfo@leviton.com](mailto:lmeinfo@leviton.com)

##### Caribbean

+1.954.593.1896  
[infocaribbean@leviton.com](mailto:infocaribbean@leviton.com)

##### India / SAARC

+91.80.4322.5678  
[infoindia@leviton.com](mailto:infoindia@leviton.com)

##### South Korea

+82.2.3273.9963  
[infokorea@leviton.com](mailto:infokorea@leviton.com)

##### China

+852.2774.9876  
[infochina@leviton.com](mailto:infochina@leviton.com)

##### Latin America

+52.55.5082.1040  
[lsamarketing@leviton.com](mailto:lsamarketing@leviton.com)

#### All Other International Inquiries

[international@leviton.com](mailto:international@leviton.com)

